

CATALOGUE 2022

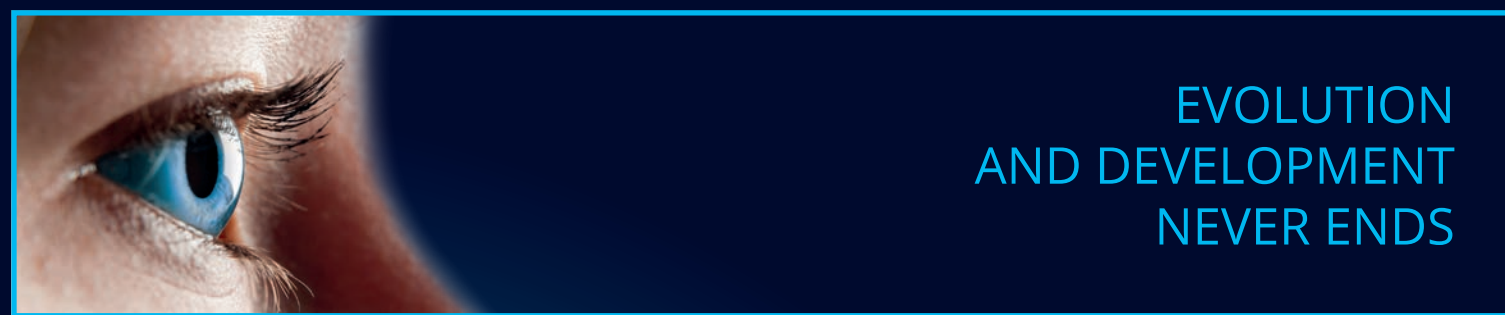

EVOLUTION  
AND DEVELOPMENT  
NEVER ENDS

CATALOGUE 2022



2022  
Rev. 01



Rev. 01



Sede /Headquarter

**Progress Profiles SpA**  
Via Le Marze 7  
31011 ASOLO (TV) Italy  
Tel. +39 0423 950398  
Fax +39 0423 950979  
Azienda certificata  
UNI EN ISO 9001:2015  
[www.progressprofiles.com](http://www.progressprofiles.com)  
[info@progressprofiles.com](mailto:info@progressprofiles.com)

Filiale /Branch Office & Warehouse

**Progress Profiles America Inc.**  
4 Middlebury Boulevard (Unit 14)  
Randolph, New Jersey 07869  
U.S.A.  
Tel. 001 973 584 2650  
Fax 001 973 584 2657  
  
[usa@progressprofiles.com](mailto:usa@progressprofiles.com)

Filiale /Branch Office & Warehouse

**Progress Profiles Middle East LLC**  
AL QUOZ INDUSTRIAL FOURTH  
26th Street, Showroom No. 1  
Dubai, U.A.E.  
Tel. 00971-04 325 1499  
Fax 00971-04 325 1466  
P.O. BOX: 29101  
  
[uae@progressprofiles.com](mailto:uae@progressprofiles.com)

Filiale /Branch Office & Warehouse

**Progress Profiles España S.L.**  
Elche Parque Industrial  
Calle German Bernacer N° 15  
03203 Elche Alicante  
España / Spain  
Tel. +34 965 057 279  
Fax +34 966 054 073  
  
[ppe@progressprofiles.com](mailto:ppe@progressprofiles.com)

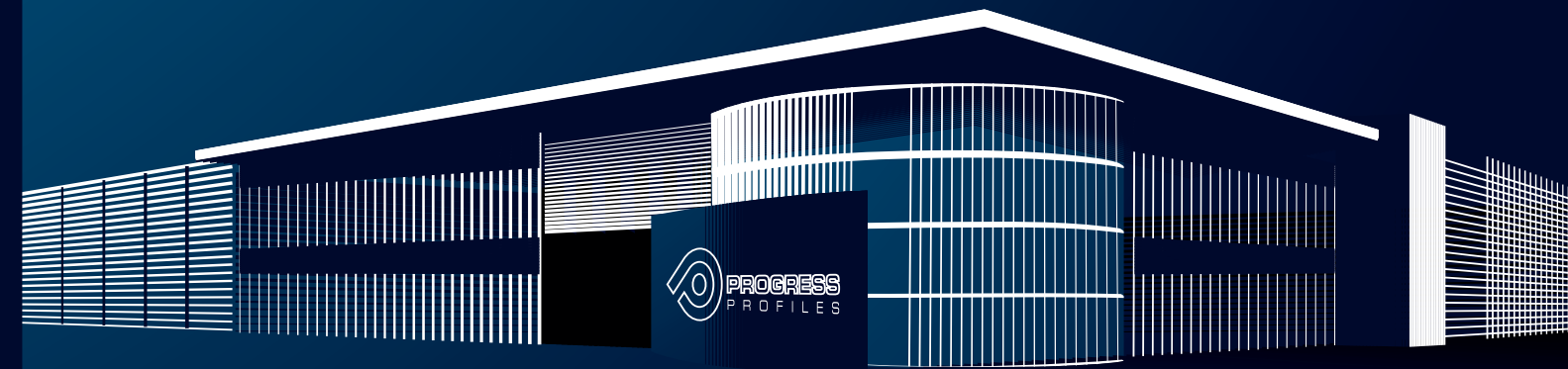

All previous price lists lose their validity on the publication of this price list. Errors, changes, and printing mistakes as well as changes necessary in the interest of product innovation or shipping reserved. For reasons of printing, colours shown in this price list may differ from actual product colours.

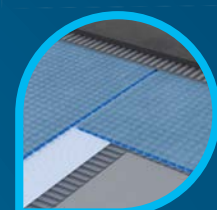
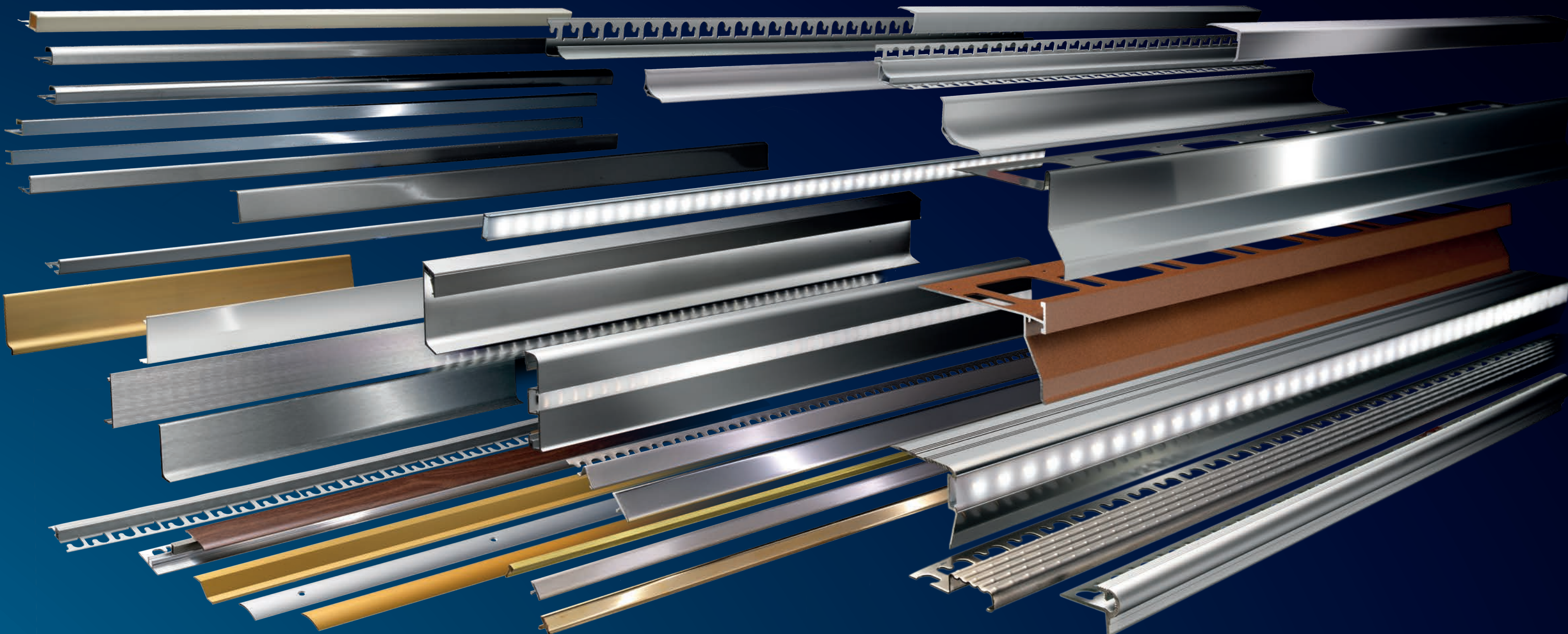

**PRODESO®  
DRAIN  
SYSTEM**



**PRODESO®  
HEAT GRIP  
SYSTEM**



**PRODESO®  
HEAT/STICK  
SYSTEM**



**PRODESO®  
MEMBRANE  
SYSTEM**

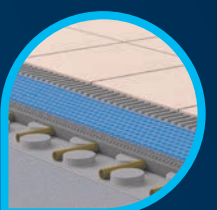

**PRODESO®  
ECO/STICK  
SYSTEM**

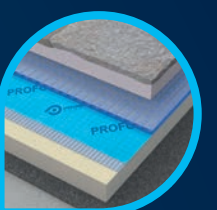

**PRODRAIN  
SYSTEM**

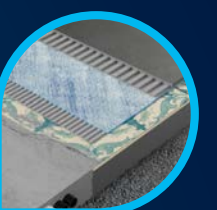

**PRODESO®  
SOUND  
SYSTEM**



**PROSHOWER  
SYSTEM**



**PROFOIL PRO/  
PROFOIL  
SYSTEM**

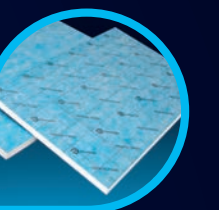

**PROFOIL PANEL  
SYSTEM**



**PROHEATER  
SYSTEM**



**PROSHELF  
SYSTEM**



**PROTERRACE  
SYSTEM**



**PROLEVELING  
SYSTEM**



**PROLEVELING  
WEDGE  
SYSTEM**



**PROSUPPORT  
TUBE  
SYSTEM**



**PRORAIL  
SYSTEM**



**PROSUPPORT  
SLIM  
SYSTEM**

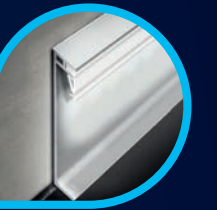

**PROLEDLIGHT  
SYSTEM**



**PROMULTIFIX  
SYSTEM**

ARTICLE	PAGE
AGA...	276
AGAC...	276
AGE...25	237-271
AGOL...	276
AGP...	277
AL...	277
ALP...	277
BOAM...	331
BRPDDR...	331
BRPDES...	331
BRPDESH...	331
BRPDESHG	331
BRPSH...	331
BRPSUP...	331
BRSYS...	331
BTA... 40	225
BTA... 60	227
BTA... 80	229
BTA...100	231
BTAC... 40	224
BTAC... 60	226
BTAC... 80	228
BTEPR 4010	269
BTEPR 7011	269
BTEPR 7016	268
BTEPR...R	233-267
BTEPR...S	232-266
BTEPR...4010	235
BTEPR...7011	235
BTEPR...7016	234
BTPF... 62A	238
BTPR...70	228-271
BTPV...	236
BTVCC...	238
C 550...	319
C...	151
CS...	146
CAT...	331
COF...	328
COL...	328
CPFM...	329
CPGC...	321
CT...	282
CU...	278
CURAS	326
CW...	278
DILV	294
DMP...	309
DPP...	294
DSVT	311
DVO...	311
ESHAN 250	325
ESPB...	331
ESPBLSH	326
ESPD	330
ESPFDP	330
ESPGLED	328
ESPGSM 18	326
ESPLED	328
ESPPDH1595	329
ESPPDHT...	329
ESPPLS...	330
ESPPST	330
ESPQC...	324
ESPSHW 70	329
FLY...	331
FTPP	300
G...	146
GCAC...	143
GCAN...	143
GCT...	305
GDA ...	150
GDA 55...	151
GDSP...	147
GNS 75...	152
GNS...	152
GPL...	73
GPSP...	148
GRP...	306
KMD	300
KSPSHWPW...	195
LVGG02	294
M...	314
MCAT...	331
MSP...	291
PBP...	121
PBPLS...	331
PC...	169
PCG...	168
PCG...	168
PCJ...	170
PCL...	73
PCM 08	111
PCPCR...	261
PCPF...	312
PCR...	89
PCR...	110
PCR...1045	86
PCR...14PT	91
PCRA...	89
PCRA...	261
PCRA...	88
PCRO...	88
PCT...	60
PCT...T	60
PCU...	291
PDA...	75
PDAACV...	111
PDAC...	74
PDES...	183
PDESDR...	175
PDESEC...	181
PDESH...	179
PDESHG...	177
PDESHK...	180
PDESHST...	181
PDKLA...	86
PDLRA...	75
PDO...	74
PDONCV...	111
PDPP...	164
PDRI 10	186
PDRP	17
PDSND...	185
PDSNDTP...	185
PDWR...	76
PDZ...	308
PED 4528...	135
PED...	132
PED...7537	135
PEDBD...	45
PEF...	185
PEF...	300
PEG...	48
PEGA...	48
PEGAC...	46
PEGO...	46
PEGR... 5230	137
PEGR...7032	136
PEGRAA 50	136
PEGRAC...	47
PEGRO...	47
PELA...	68
PELAACV...	107
PELO...	68
PELONCV...	107
PEM...	337
PEN...	150
PENF...	149
PESP...	327
PETA...	91
PETAC...	90
PETFX...	153
PETFXPAA...	153
PETO...	90
PFC...40	45
PFD...	166
PFDPP...	165
PFO...	186
PFO...	204
PFL...	186
PFLPAN...	187-202
PFLPANICH...	203
PFLPST...	204
PFLT...	44
PFPSAL...	295
PFR...1216	84
PFR...24...	85
PFR... 712	83
PFRAC...712	83
PFRAC...712	83
PFTT...	301
PFX...	144
PFX25...	148
PFX5...	144
PFXSPR...	145
PFXAC...	140
PFACN...	142
PFACPR...	140
PFAL...	141
PFALN...	142
PFOT...	141
PFAO...	71
PFAW...15	238
PFAW...15	270
PGBOR...	187-205
PGR...	117/137
PHTST...	206
PI...	32
PI...	33
PI...	279
PI...	279
PIAC...	30-31
PIKL...	32
PIKL...	160
PIKLAC...	30-31
PIKLAC...	160
PINS...A	268
PINS/PNSP...	263
PINT...	261
PINT...CV...	110
PINTPC...	252
PINTPC...	266
PINYC...	254
PINYLC...	255
PINZ...	262
PINZ...A	268
PINZC...	250
PINZC...	266
PISPC...	249
PISPC...	266
PITA...	72
PITO...	72
PJ...	18-21
PJ...	22
PJ...	23
PJACV...	109
PJAC...	15-16
PJE...	24
PJE...	25
PJO...	17
PJONCV...	109
PJP...	23
PJQ...	9
PJQ...	6-8
PJQSAC...	2-3
PJQSAC...	5
PJQT...	11-13
PJQT...	14
PJQAT...	10
PJTR...	28
PJTR135...	29
PJTRAC...	26
PJTRAC...	27
PJTRO...	27
PKAA...	220
PKCHAA...	211
PKFLAA...	211
PKGLDAA...	219
PKINSAA 60	212
PKINSAA...	213
PKLEDAA...	217
PKLIAA 60	212
PKLJ...	156
PKLL...	58
PKLL...	58
PKLL...	157
PKLL...	157
PKLQ...	156
PKLT...	214-215
PKSHAA 70	221
PLF...	309
PLF...R...	309
PLFE...	309
PLGAN...	67
PLGO...	67
PLS...	97
PLSAC...	93-94
PLSO...	95-96
PLT...	43
PLTAC...	40-41
PLTCH...	34
PLTCH...	34
PLTCHAA...	198
PLTCHAC...	198
PLTLED	43
PLTP...	42
PLTP...	41
PLU...16	85
PLV...	99
PLV...29	79
PLV...30...	80
PLV...32	80
PLVOL 33	79
PLVOL 358...	81
PLVOL 4413	81
PMC...	101
PMF...	100
PMG...	101
PMPFX...	245
PMQ...	100
PNPLS...	330
PNPLWS...	330
PNPSR...	330
PNSP...A	271
PNVA... 713	82
PPD...	305
PPN...	312
PPO...	313
PPS...	313
PPT...	304
PPU...	310
PPV...	310
PPX...	313
PPY...	311
PQE...	71
PRB...	184,186
PRB...	204
PRBBU...	184
PRBFX...	184
PRBFX...	204
PRBFX...	300
PRBKL	184
PRBKLAB	184
PRBPE...	183
PRBPE...	204
PRCLEAN	300
PRCP...	239
PRDAC	51
PRFA...	71
PRFAACV...	108
PRFAC...	70
PRFO...	70
PRFONCV...	108
PRLISH	300
PRLW...	290
PRMKL	184
PROSHELF...	205
PRS...	289
PRS...712...	84
PRSPD 10	301
PRTA...	78
PRTAC...	77
PRTO...	77
PS...	53
PSA...	55-56
PSAW...20	238
PSAW...20	270
PSB...	57
PSBF...	57
PSD...	306
PSDWK...	123
PSDWK...	166
PSF...	56
PSH...DK	171
PSHA...	52
PSHAC...	50-51
PSHANT...	191
PSHD...	159
PSHPAN	190
PSHPANC	200
PSHPANCEK...	200
PSHPANEK	190
PSHPANXT...	190
PSHR...	159
PSHVDK	201
PSHW...	192
PSHWBB...	191
PSHWCP	171
PSHWCP	201
PSHWDL...	191
PSHW...	194
PSHW...	194
PSHW...	194
PSHW...	196
PSHW...	197
PSHWPGACS...	196
PSHWPLACS...	197
PSHWRD 5040	193
PSHWRD...	193
PSLD...	78
PSM...	301
PSPRPT...	295
PSS...	54
PST...	292
PST...	306
PSTAK	294
PSTJ	294
PSTR...	296
PSTRP...	295
PSTSL...	298
PSTW...	294
PSTWP	298
PSWC...	264
PSYA...	127
PSYAC...	126
PSYACS 2610	114
PSYGRACS 6020	118
PSYKLA 1045	161
PSYO...	126
PSYW...	129
PT...	37-39
PT...	39
PTA...	66
PTAC...	16,36
PTAC...	64-65
PTACV...	104
PTANCV...	105
PTEDP...	167
PTEE...	167
PTER...	169
PTI...	35
PTO...	65
PTO...	37
PTONCV...	105
PTP...	120
PTPW...	129
PTR...	120
PTR50...	119
PTRACS...	114
PTRB...	121
PTRGRACS...	117
PTRKLA 2045	161
PTRLEDA...	124
ptrw...	128
PTS...	128
PTS... 613	82
PTSA...	127
PTSA...	253
PTSPA...	122
ptspac...	59
PTSPAC...	122
PWJ...	320
PWK...	133
PWK...	259
PWK...25...	134
PWKAC...	132
R...	291
R...	304
R...	304
R...	304
R...	306
SAC...	312
SC...	131
SO...	131
SPCDES...	329
SPCPDES...	329
SQG...	299
T...	282
TCT...	131
TDA...	304
TET...	131
TGS...	131
TP...	280
TQP...	280

PC...	169
PCG...	168
PCG...	168
PCJ...	170
PCL...	73
PCM 08	111
PCPCR...	261
PCPF...	312
PCR...	89
PCR...	110
PCR...1045	86
PCR...14PT	91
PCRA...	89
PCRA...	261
PCRA...	88
PCRO...	88
PCT...	60
PCT...T	60
PCU...	291
PDA...	75
PDAACV...	111
PDAC...	74
PDES...	183
PDESDR...	175
PDESEC...	181
PDESH...	179
PDESHG...	177
PDESHK...	180
PDESHST...	181
PDKLA...	86
PDLRA...	75
PDO...	74
PDONCV...	111
PDPP...	164
PDRI 10	186
PDRP	17
PDSND...	185
PDSNDTP...	185
PDWR...	76
PDZ...	308
PED 4528...	135
PED...	132
PED...7537	135
PEDBD...	45
PEF...	185
PEF...	300
PEG...	48
PEGA...	48
PEGAC...	46
PEGO...	46
PEGR... 5230	137
PEGR...7032	136
PEGRAA 50	136
PEGRAC...	47
PEGRO...	47
PELA...	68
PELAACV...	107
PELO...	68
PELONCV...	107



## Look into our eyes and we will tell you who we are

### **A story a human character and perseverance.**

Bold decisions. Ours is a story of accomplishments that started in Canada in 1965 and blossomed in Italy . The extensive know-how acquired over 55 years of prior experience in the field of plastic extrusion and metal profiles brought to the company's turning point occurred during the 90s. This was a period rich in investments in additional qualified personnel, state-of-the-art machinery, and cutting edge innovations that opened the doors to internationalization and the development of innovative solutions for ceramic tiles, marble, wood/parquet, laminate and vinyl flooring, fitted carpets, resin or concrete flooring, mosaic and low thicknesses flooring and innovative fixing/ Laying Heating, Uncoupling and waterproofing membrane systems. All this took PROGRESS PROFILES® in a new trajectory, as demonstrated by the quick growth of the company which became increasingly larger and articulate, recognized as a true reference point in the market. This great success is mainly due to the team play spirit within our company. Highly dedicated, trained and skilled professionals in every single department, technical, training, design, manufacturing, sales, logistic, marketing allow us to bring constantly innovative solution to the international marketplace. In particular investments in marketing and marketing support has been clearly visible in and a wide range of technical catalogues, leaflets and marketing material, which have led the company, already having a leading position in the international market and being the undisputed leader in the Italian market, to achieve the goal of over 10000 active and satisfied clients.





The eyes are the mirror of the soul and of the company



**Explore new ideas to constantly improve, by testing and challenging existing practices.**

An example of cutting-edge entrepreneurship with determined goals and a forward-looking action plan aiming at capturing the latest trends in the sector. All this is proved by over 37 years of success in the International market, a steadily increasing turnover, and a solid business context, which, as of today, boasts over 130 employees and a network of over 120 high-profile national and international agents, and three headquarters located abroad, in America, Dubai and Spain, to promote Italian high quality through a bold internationalization policy. A dynamic policy that is expressed in the participation in the most important International trade fairs, as well as in a cooperative International dialog with several of the main characters in the design and architectural spaces of today trend development. This dialog is critical and challenging but the company faces it with great enthusiasm and desire to grow through idea exchanging and learning.

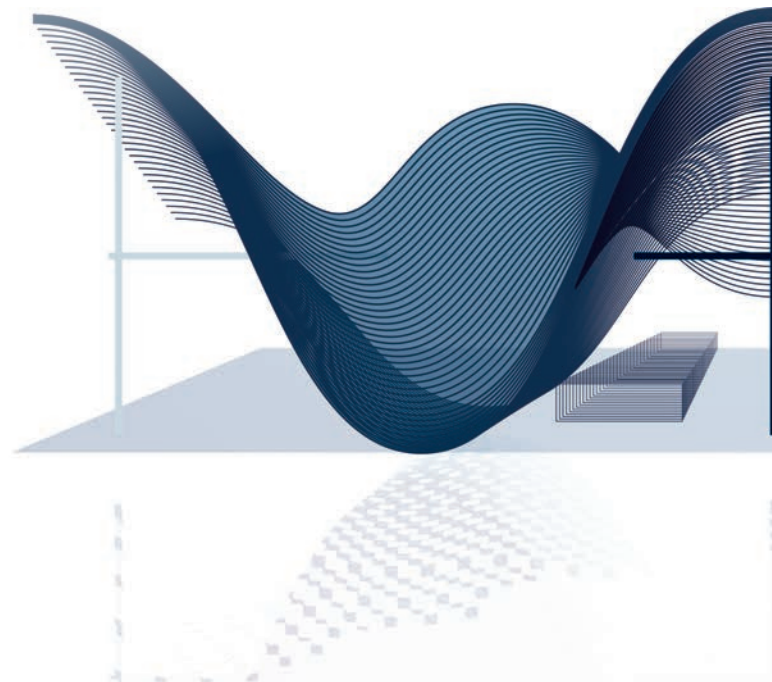



A glance at the future



### **Following the entire product life cycle from idea to project and finally to finished product**

The wide range of PROGRESS PROFILES® products is the result of over 37 years of research and development applied to the most advanced technologies and materials available on the market to create exclusive, functional and state-of-the-art solutions for improving the quality of the finished project, while reducing the installers efforts. These objectives have guided the company policy of important investments in enhancing the Planning Office, acquiring state-of-the-art equipment and a team of professionals that are able to seize the soul of a product and develop its full potential and performances, according to all the customer requirements and trends of the sector. A policy that has led the company to invent, design, and deposit patents and trademarks aiming at promoting and overturning established application concepts.

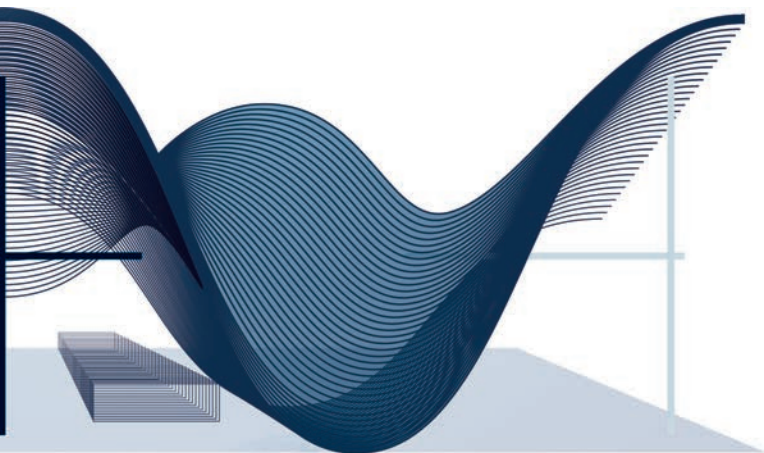



# Eyes wide open on innovation

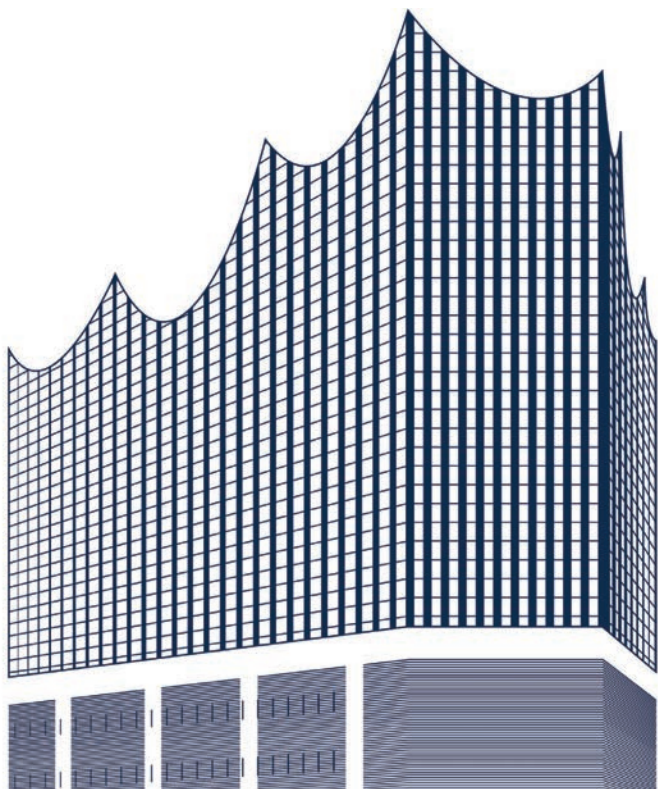

## **Learning and Technical Training is the most important investment for any enterprise.**

PROGRESS PROFILES® feather in the cap is the depth of training offers reserved to employees and clients, in which the company has, since the beginning, invested a large amount of energy and resources. To confirm such focus in the recently inaugurated (2015) Headquarters in Asolo the company has set up a 200 sqm showroom and 500 sqm training facility and training center equipped with latest technologies to allow operators of the trade – Italian and foreign representatives, architects, engineers, planners, designers, building and Tile laying fixers companies to view and to acquire the technical knowledge needed to use the latest product in their trade. This is achieved through practical demonstrations, video tutorials on laying methods, technical seminars and workshops, all held by accomplished, skilled and accredited professionals. All this transfer of knowledge and information to our internal and external partners is accompanied by certifications and standards documents that further strengthens and enrich the quality of their overall training, allowing them to be always up-to-date on the latest systems and products in their field.



A company that sees clearly

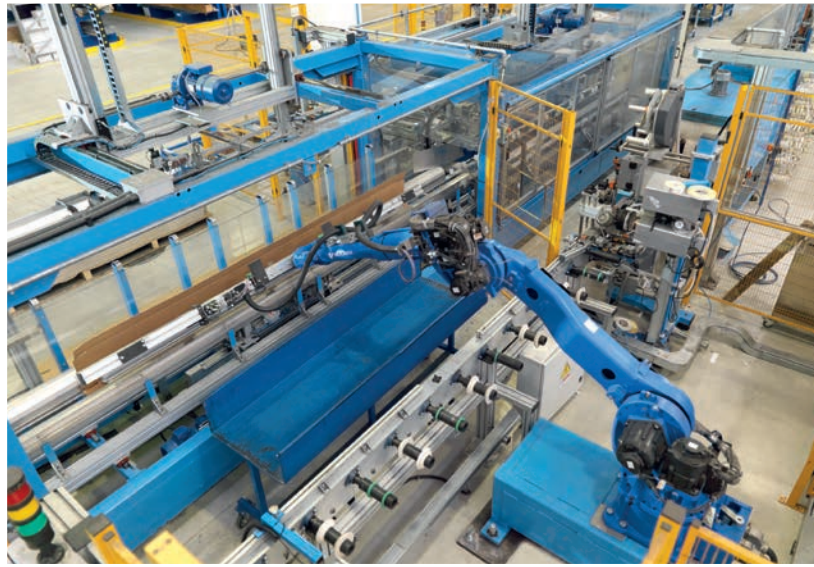

## First of all, Made in Italy.

The new headquarters in Asolo, with an indoor area of over 16000 sqm and equipped with a photovoltaic roof system, generating 800 kWh, can boast state-of-the-art technology equipment: latest generation machinery for processing stainless steel, aluminium, brass, PVC and real wood, as well as packaging, labelling and assembling machines. The result of all this are the over 30 million linear metres of its profiles that are laid every year. High-quality and great aesthetic impact characterise the wide range of PROGRESS PROFILES® products, which includes over 15000 technical and design solutions and system, most of which are

patented, for interior finishes, laying ceramic and wood, as well as for residential and commercial buildings. A wide range of products that has grown over the years through advanced technological processes that have led to the development of products, materials, and innovative modern finishes, such as anodized, polished and brushed titanium, copper, chrome and Gold, Tiltex, Black line, Tuscany line, Stone line and the latest heating and uncoupling membranes and shower systems. The entire production is strictly Italian made and ISO 9001:2015 certified. The excellence of the results is the proof.



We keep an eye on everything!



**Everything at its place to guarantee efficiency and punctuality.**

The logistics system devised by PROGRESS PROFILES® for the operative management of the complex warehouse is emergency proof. Studied in the slightest detail according to the most advanced methods and logics of the system, it ensures a systematic organization of the goods in a total space of 8000 sqm, which allows an efficient and punctual service and prompt delivery any time of the year. Moreover, a state of the art software management service is actively keeping direct and constant control over the entire order procedure, leaving nothing to chance and ensuring maximum reliability and accuracy.

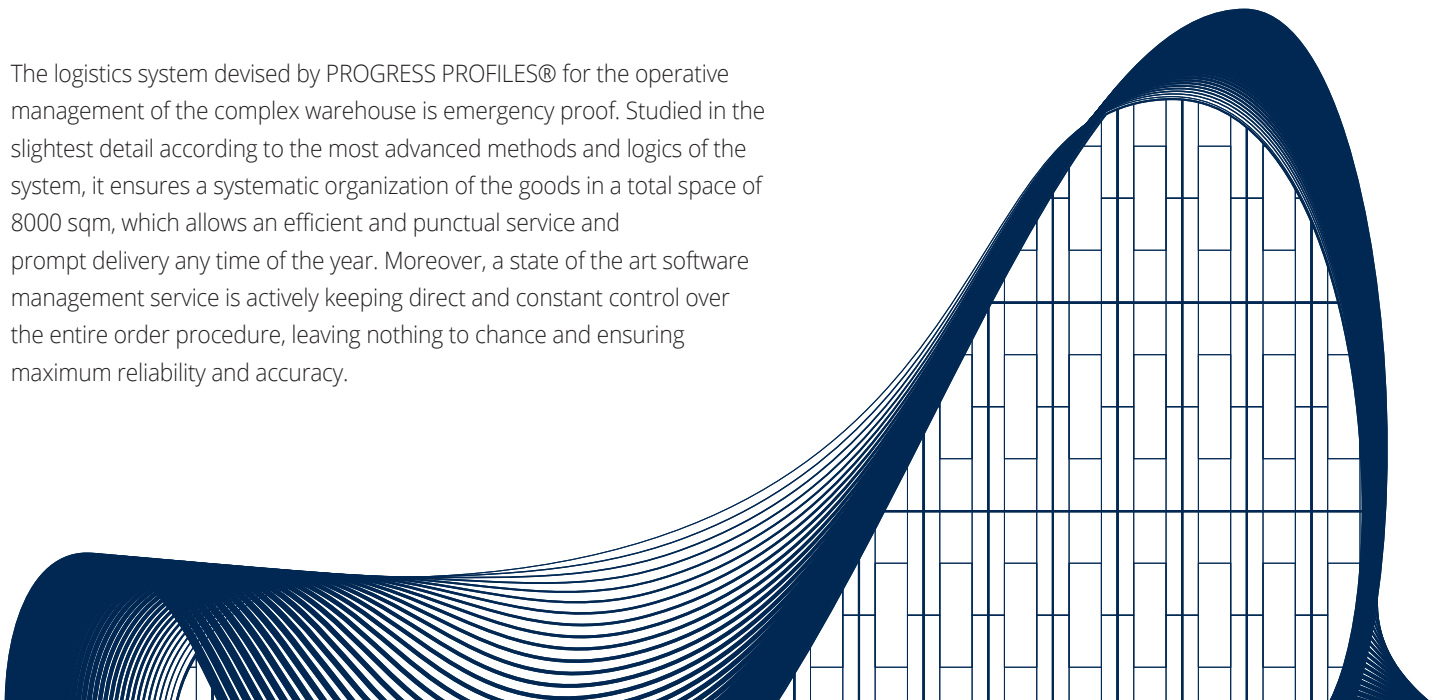





An eye for detail that make the difference



**The quality can be seen, touched and is 100% guaranteed.**

Every PROGRESS PROFILES® product is made and tested according to the strictest standards that allow us to guarantee their excellence from every point of view. At the forefront in the quality, the company operates with a management system certified according to UNI EN ISO 9001 since 1999, among the first in the world in its field, and it is today ISO 9001:2015 certified. An absolute certainty of reliability that is ensured also by important company choices: 100% made in Italy,

the exclusive use of non-toxic materials and top quality stainless steel, aluminium and brass alloys, conforming to Italian and International standards, the choice of high quality raw materials and their use in compliance with the REACH requirements, implementing the LEED products mapping system for gaining GREENTOP credits, and more in general, by the ability to offer a service designed in the slightest detail to meet all requirements and make a difference in the market.



contributes to  
88 PE, 84 C1, 90 PE (elementi)  
89 PE (elementi), 82 C1 (elementi)  
CREDITS





A forward-looking company



### **A courageous international growth campaign.**

PROGRESS PROFILES® sales network in Italy and abroad creates a capillary knowledge and support delivery system. Even though as today 60% our turnover is made within the Italian national territory, there are over 80 countries accounted for worldwide where the company exports and sells its products. Apart from the main markets such as France, Austria, Greece, Portugal, Germany, Switzerland, Scandinavia, England, Ireland, Belgium, India, Australia, New Zealand – the company is also present in the countries of former Yugoslavia and Eastern Europe, in particular Russia, Croatia

, Hungary, Slovenia, Czech Rep. Slovakia, Poland in all the countries of the Middle East, Africa, and Central and South America. As a demonstration of the importance of the internationalization process, the company takes part in all the most important trade fairs of the sector and has recently created headquarters in 3 major contemporary business capitals: U.S.A.: Progress Profiles America Inc., U.A.E.: Progress Profiles Middle East LLC., and SPAIN: Progress Profile España S.L

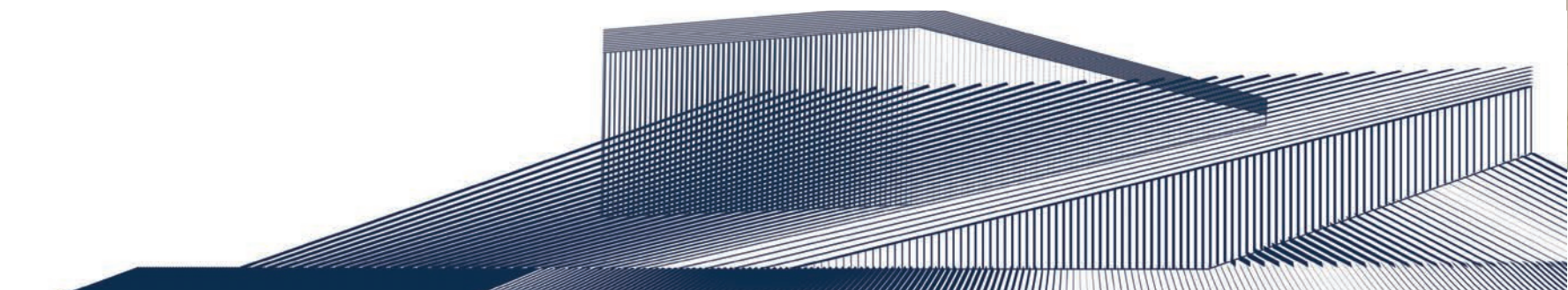









CATALOGUE SECTIONS INDEX		PG
●	PROFILES FOR WALLS	1 - 61
●	PROFILES FOR FLOORS	62 - 101
●	BENDABLE & CURVE PROFILES	102 - 111
●	STAIR NOSING PROFILES	112 - 137
●	EXPANSION JOINTS	138 - 153
●	LOW THICKNESS PROFILES	154 - 161
●	PROFILES FOR TERRACES	162 - 171
●	MEMBRANES & PANELS	172 - 187
●	SHOWER SYSTEMS	188 - 207
●	SKIRTING BOARDS	208 - 239
●	PROFILES FOR LAMINATES & LVT FLOORS	240 - 273
●	DO IT YOUR SELF	274 - 283
●	PRODUCTS FOR LAYING	284 - 301
●	BUILDING SYTEMS	302 - 321
●	MARKETING	322 - 339
🔄	News	
◆	Stainless steel AISI 316/1.4044 V4A profiles	

A	●	ADHESIVE LAID JOINT PVC	146	
	🔄	● BROCHURE	331	
B	●	CANAL DOUBLE U FORM ALU.	278	
	●	CANAL U FORM ALU.	278	
C	🔄	● CATALOGUE	331	
	🔄	● COLOUR RANGE	328	
D	●	CORNER PVC	237,371	
	●	CURTAINBLACE ALU.	282	
	●	CURVE PROFILE ALU.	281	
	●	DOPPY	311	
	●	DRAIN REDUCTION	193	
	●	DRIP PVC	305	
	E	●	EMPTY RECTANGULAR TUBE ALU.	280
		●	EMPTY SQUARE TUBE ALU.	280
	●	EMPTY TUBE ALU.	279	
	●	END CAPS FOR DISTANCE TUBE	312	
	●	EQUAL SIDES CORNER ALU.	276	
	●	EQUAL SIDES CORNER BRASS	276	
	●	EQUAL SIDES CORNER PVC	277	
	●	EQUAL SIDES CORNER STEEL	276	
	●	EXP. PRODESO HEAT /PRODESO/PROTERRACE	329	
	●	EXP. PROLEVELING SYSTEM 5/7 VANI	330	
	●	EXP. PROLISTEL/ skirting	326	
	●	EXP. PROSHOWER SYSTEM	329	
	●	EXP. PROSUPPORT TUBE	330	
	●	EXP. PROTERRACE	330	
●	EXPOSURE WALL	325		
F	●	EYELET SUPPORT	131	
	●	FINISHES CASE	328	
G	●	FINNED SPACER TUBE PVC	304	
	●	FIREPROOF CORD	151	
H	🔄	● FISHBONE RIBBED JOINT PVC	306	
	🔄	● FLAT BRASS	279	
I	●	FLAT ALU.	279	
	●	FLAT SPACER	312	
L	🔄	● FLYER	331	
	●	FLYER EXPO. DISPLAY	331	
M	●	FULL ROUND TUBE ALU.	280	
	●	FULL SQUARE TUBE ALU.	281	
N	🔄	● GADGET	339	
	●	GAP-COVERING BALLON SHEATH	319	
O	●	GASKETS FOR PRECAST FORMS	314	
	●	GDA 25, GDA 35, GDA 55 ALU.	150,151	
P	●	GNS 20, GNS 50, GNS 75 ALU.	152	
	●	HINGE SUPPORT	131	
R	●	IRON	283	
	●	L FORM CORNER PVC	277	
S	●	L FORM CORNER ALU.	277	
	●	LVT PROFILES (top)	271	
T	●	MAGNET KIT	300	
	●	MEMBRANE CASE	329	
U	●	MEMBRANE EXP. DISPLAY	337	
	●	MINI CATALOGUE EXPO. DISPLAY	331	

🔄	●	MINICATALOGUE	331
●	MODULAR ASSEMBLY KIT	193	
●	MODULAR DISPLAY SYSTEM	332	
●	MORTAR LAID DOUBLE JOINT PVC	147	
●	MORTAR LAID FULL JOINT PVC	148	
●	MORTAR LAID JOINT PVC	147	
●	MORTAR LAID JOINT STEEL-BRASS- ALU.	146	
●	MULTIPIEDE	309	
●	MULTISPACER	291	
P	●	PAU	310
	●	PAV	310
●	PAV/JJOINT PVC	320	
●	PAX-PAL-PAS SPACERS	313	
●	PRO GOBOARD PANEL	205	
●	PROANGLE BRASS	71	
●	PROANGLE WOOD PVC	238,27	
●	PROBAND 150/250	186	
●	PROBAND BU	184	
●	PROBAND FIX	184	
●	PROBAND KOLL	184	
🔄	●	PROBAND KOLL AB	184
●	PROBATH FLEX PVC	57	
●	PROBATH PVC	57	
●	PROBORD STEEL	45	
●	PROBRASSTEP ALU.	121	
●	PROCANAL BRASS-ALU.	73	
●	PROCAP S/L	239	
●	PROCARE CLEAN	300	
●	PROCARPET ACC STEEL	77	
●	PROCARPET ALL ALU.	78	
●	PROCARPET OTT BRASS	77	
●	PROCOVER 1045 ALL	86	
●	PROCOVER 14PT ALU.	91	
●	PROCOVER ALU.	89,110	
●	PROCOVER BRASS	88	
●	PROCOVER STEEL	88	
●	PROCOVER WOOD	110,261	
●	PROCURVE MACHINE	111	
🔄	●	PRODESO / PRODESO HEAT EXPO.	329
🔄	●	PRODESO DRAIN	175
●	PRODESO ECO/STICK	181	
●	PRODESO HEAT GRIP SYSTEM	177	
●	PRODESO HEAT SYSTEM/HEAT STICK	179,180,181	
●	PRODESO MEMBRANE	183	
●	PRODESO SOUND	185	
●	PRODESO SOUND TAPE	185	
●	PRODILAT ALU.	143	
●	PRODILAT STEEL	143	
●	PRODISTANZ	308	
●	PRODRAIN 10	186	
●	PRODRIP	171	
●	PRODUCTS DISPLAY	330	
●	PROECOFON	185	
●	PROEDGE AC STEEL	46	
●	PROEDGE AL ALU.	48	
●	PROEDGE FLEX PVC	45	
●	PROEDGE OT BRASS	46	
●	PROEDGE PVC PVC	48	
●	PROEDGE R AC STEEL	47	
●	PROEDGE R OT BRASS	47	
●	PROELEGANT ALU.	68	
●	PROELEGANT BRASS	68	
●	PROELEGANT CURVE ALU.	107	
●	PROELEGANT CURVE BRASS	107	
●	PROEND 5050 ALU.	136	
●	PROEND ALU.	132	
●	PROEND GRIP 70 ALU.	136	
●	PROEND GRIP ALU.	137	
●	PROEND INS 75 ALU.	135	
●	PROEND INS ALU.	135	
●	PROEXPAN 115-130-190-210 ALU.	149	

●	PROEXPAN H20-H40 ALU.	150	
●	PROFILE WITH DOUBLE CHAMFER PVC	306	
●	PROFILE WITH TRIANGULAR CHAMFER PVC	306	
●	PROFILES EXP. DISPLAY	337	
●	PROFINAL ALU.	71	
●	PROFINAL BRASS	70	
●	PROFINAL CURVE ALU.	108	
●	PROFINAL CURVE BRASS	108	
●	PROFINAL STEEL	70	
●	PROFINLIST 20 ALU.	44	
●	PROFIXER LINE SYSTEM ALU.	262	
●	PROFLAT STEEL-BRASS	73	
●	PROFLEX 25 PVC	148	
●	PROFLEX 5 PR PVC	145	
●	PROFLEX 5 PVC	144	
●	PROFLEX ACC PR STEEL	140	
●	PROFLEX ACC STEEL	140	
●	PROFLEX ACN STEEL	142	
●	PROFLEX AL ALU.	141	
●	PROFLEX ALN ALU.	142	
●	PROFLEX OT BRASS	141	
●	PROFLEX PVC	144	
●	PROFLOOR 1216 STEEL-BRASS	84	
●	PROFLOOR 24 STEEL-BRASS	85	
●	PROFLOOR 712 ALU.	83	
●	PROFLOOR 712 BRASS	83	
●	PROFLOOR 712 STEEL	83	
🔄	●	PROFOIL / PROFOIL PRO	204
🔄	●	PROFOIL CORNERS	186
●	PROFOIL PANEL	202	
●	PROFOIL PANEL ACCESSORIER	202	
●	PROFOIL PANEL NICHE	203	
●	PROFOIL PASTE	204	
●	PROGRIP	117,137	
🔄	●	PROHEATER	206
●	PROINSERT (optional)	273	
●	PROINSERT (top)	272	
●	PROINSERT SAMPLES	328	
●	PROINTER AC STEEL ◆	30	
●	PROINTER AL ALU.	32	
●	PROINTER KL ACC STEEL ◆	30,160	
●	PROINTER KL ALL BRASS-ALU.	33,160	
●	PROINTER PVC	33	
●	PROJOINT ALU.	72	
●	PROJOINT BRASS	72	
●	PROJOLLY ALU.	18,21	
●	PROJOLLY ANGLE 135 STEEL	29	
🔄	●	PROJOLLY BRASS	17
●	PROJOLLY CURVE ALU.	109	
●	PROJOLLY CURVE BRASS	109	
●	PROJOLLY ECO MARBLE PVC	25	
●	PROJOLLY ECO PVC	24	
●	PROJOLLY MARBLE PVC	23	
●	PROJOLLY OPEN PVC	23	
●	PROJOLLY PVC	22	
●	PROJOLLY QUART ALU.	11,13	
●	PROJOLLY QUART PVC	14	
●	PROJOLLY QUART STEEL	10	
●	PROJOLLY SQUARE ALU.	6,8	
🔄	●	PROJOLLY SQUARE BRASS	5
●	PROJOLLY SQUARE PVC	9	
🔄	●	PROJOLLY SQUARE STEEL ◆	2,3
●	PROJOLLY STEEL ◆	15,16	
●	PROJOLLY TRIANGLE ALU.	28	
●	PROJOLLY TRIANGLE BRASS	27	
●	PROJOLLY TRIANGLE STEEL	26	
●	PROKERLAM JOLLY ALU.	156	
🔄	●	PROKERLAM LINE	58,157
●	PROKERLAM SQUARE ALU.	156	
●	PROLEVALL 25-35-38 ALU.	99	
●	PROLEVALL 29 ALU.	79	

●	PROLEVALL 305 STEEL-BRASS	80
●	PROLEVALL 32 ALU.	80
●	PROLEVALL 33 BRASS	79
●	PROLEVALL 358 BRASS	81
●	PROLEVALL 4413 BRASS-ALU.	81
●	PROLEVELING SYSTEM	289
●	PROLEVELING SYSTEM DISPLAY	330
●	PROLEVELING WEDGE SYSTEM	290
●	PROLEVELING WEDGE SYSTEM DISPLAY	330
●	PROLEVIGAL ALU.	67
⦿	PROLEVIGAL BRASS	67
●	PROLINOLEUM ALU.	85
●	PROLISTEL ACC STEEL ◆	40,41
●	PROLISTEL ALL ALU.	43
●	PROLISTEL CHANNEL ALU.	34,198
⦿	PROLISTEL CHANNEL STEEL	34,198
●	PROLISTEL LED ALU.	43
●	PROLISTEL P ALL ALU.	42
●	PROLISTEL P OTT	41
⦿	PROMEMBRANE KOLL	182
●	PROMOQUETTE ALU.	100
●	PROMOQUETTE CLIP ALU.	101
●	PROMOQUETTE FIX ALU.	100
●	PROMOQUETTE GIN ALU.	101
●	PROMULTIFIX SYSTEM	245
⦿	PROMULTISKIRT ROUND pvc	233,267
⦿	PROMULTISKIRT SQUARE pvc	232,266
●	PRONIVO ALU.	82
●	PROPLATE 80 ALZ ALU.	91
●	PROPLATE BRASS	90
●	PROPLATE FIX ALU.	153
●	PROPLATE FIX PVC	153
●	PROPLATE STEEL	90
●	PROPOLISH	300
●	PROPRESS 712 STEEL-BRASS	84
●	PRORAIL SYSTEM	296
●	PROROUND STEEL	54
●	PROSANI STRIP PVC	54
●	PROSCREW ALU. BASE + TOP	264
●	PROSCREW ALU. TOP	264
●	PROSCREW BASE ALU.	264
●	PROSEAL 25 PVC	56
●	PROSEAL 50 PVC	55
●	PROSEAL FLEX PVC	56
●	PROSEAL WOOD PVC	238,270
●	PROSGUSCIO DA PVC	53
⦿	PROSHELF ◆	205
●	PROSHELL ALL ALU.	52
●	PROSHELL D ALL ALU.	159
●	PROSHELL R ALL ALU.	159
⦿	PROSHELL STEEL ◆	50,51
●	PROSHOWER BASE BASIC PVC	191
⦿	PROSHOWER BASE L PRO STEEL ◆	194
●	PROSHOWER BASE L STEEL	191
●	PROSHOWER CENTRAL PANEL	200
⦿	PROSHOWER DRAIN CENTRAL PRO STEEL ◆	201
●	PROSHOWER DRAIN LATERAL	201
●	PROSHOWER DRAIN VERTICAL	271
●	PROSHOWER LINEAR KIT SYSTEM	190
●	PROSHOWER PANEL	190
●	PROSHOWER PANEL EXTENSION	190
●	PROSHOWER PROFILE	196
●	PROSHOWER PROFILE FRONT	197
●	PROSHOWER PROFILE GLASS	196
●	PROSHOWER PROFILE WALL	197
⦿	PROSHOWER TOP PRO STEEL ◆	195
●	PROSHOWER TOP STEEL	192
●	PROSIDE WALK ALU.	123,165
●	PROSKID BRASS-ALU.	78
●	PROSKIRTING 40 ALU.	221
●	PROSKIRTING ALU.	220

●	PROSKIRTING CHANNEL ALU.	211
●	PROSKIRTING FLAT ALU.	211
●	PROSKIRTING GILED ALU.	219
●	PROSKIRTING INS ALU.	212
●	PROSKIRTING ISP ALU.	213
●	PROSKIRTING LED ALU.	217
●	PROSKIRTING LED/ GILED DISPLAY	228
●	PROSKIRTING LINE ALU.	211
●	PROSKIRTING LIST	214,215
●	PROSKIRTING SHELL ALU.	221
●	PROSLIDER ALU.	75
●	PROSLIDER BRASS	74
●	PROSLIDER CURVE ALU.	111
●	PROSLIDER CURVE BRASS	111
●	PROSLIDER KL ALL ALU.	86
●	PROSLIDER LR ALU.	75
●	PROSLIDER STEEL	74
●	PROSLIDER WOOD	76
●	PROSOL 18-30-35-40 BRASS	95,96
●	PROSOL 18-30-35-40 STEEL	93,94
●	PROSOL 30-35-40 ALU.	97
●	PROSQUARE BRASS	71
●	PROSTAIR 50 ALU.	119
●	PROSTAIR ACC STEEL	114
●	PROSTAIR ALU.	120
●	PROSTAIR BOTTON / STRIP STEEL	121
●	PROSTAIR GRIP ACC STEEL	117
●	PROSTAIR KL 20 ALU.	161
●	PROSTAIR LED ALU.	124
●	PROSTAIR WOOD	128
●	PROSTAIR WOOD Z	128
●	PROSTEP INS ALU.	127,253
●	PROSTEP PVC	120
●	PROSTEP WOOD	129
●	PROSTYLE 2610 STEEL	114
●	PROSTYLE ALU.	127
●	PROSTYLE BRASS	126
●	PROSTYLE GRIP ACC STEEL	118
●	PROSTYLE KL 10 ALU.	161
●	PROSTYLE STEEL	126
●	PROSTYLE WOOD	129
●	PROSUPPORT PROFILE A & B	295
●	PROSUPPORT PROFILE T & N	295
●	PROSUPPORT SLIM SYSTEM	298
●	PROSUPPORT TUBE SYSTEM	292
⦿	PROTERMINAL ALU.	37,66
⦿	PROTERMINAL BRASS	37,65
●	PROTERMINAL CURVE ALU.	105
●	PROTERMINAL CURVE BRASS	105
●	PROTERMINAL CURVE STEEL	104
●	PROTERMINAL INT ALU.	35
●	PROTERMINAL PVC	39
●	PROTERMINAL STEEL ◆	36,64
●	PROTERMSTEP ACC STEEL	122
●	PROTERMSTEP ALL ALU.	59,122
⦿	PROTERRACE DOUBLE DRIP	164
●	PROTERRACE DRAIN DRIP ALU.	165
●	PROTERRACE DRAIN FDP ALU.	166
●	PROTERRACE ECO ALU.	167
●	PROTERRACE ECO DRIP ALU.	167
●	PROTERRACE PC ALU.	169
●	PROTERRACE PC STEEL	169
●	PROTERRACE PCG ALU.	168
●	PROTERRACE PCG STEEL	168
●	PROTERRACE PCJ ALU.	170
●	PROTERRACE PTER STEEL	170
●	PROTOP ALU.	60
●	PROTOP T ALU.	60
●	PROTRANS ALU.	82
●	PROWALK 2510 & 2520 ALU.	134,253

## R

## S

## T

## W

## Z

●	PROWALK ACC STEEL	132
●	PROWALK BRASS-ALU.	133
●	RAPY 100	309
●	RAPY 100 ECO	309
●	RAPY 200	309
●	RIBBED SPACER TUBE PVC	305
●	ROLLER	301
●	ROTATING EXP. STAND	326
●	ROUNDED TRIANGULAR PVC	306
●	SAMPLE BOARDS	327
●	SCISSORS FOR PVC PROFILES	300
●	SHEAT LAYING TROLLEY	321
●	SHOWROOM PROPOSALS	334
⦿	SKIRTING 100 ALU.	231
●	SKIRTING 100-150 STEEL	230
⦿	SKIRTING 40 ALU.	225
●	SKIRTING 40 PVC	235,269
●	SKIRTING 40 STEEL	224
⦿	SKIRTING 60 ALU.	227
●	SKIRTING 60 STEEL	226
●	SKIRTING 60/120 PVC	236
●	SKIRTING 62F PVC	236
●	SKIRTING 7011 PVC	235,269
●	SKIRTING 7016 PVC	234,268
⦿	SKIRTING 80 ALU.	229
●	SKIRTING 80 STEEL	228
●	SKIRTING COVECAP PVC	239
●	SKIRTING PVC	236,270
●	SMALL EXPOSURE STAND	320
●	SNAP-ON STRAND SHEAT PVC	304
●	SNAP-ON STRAND SHEAT TUBE PVC	304
●	SOL 30 SELFADHESIVE ALU.	260
●	SOL 30P LVT	258
●	SOL 40 P ALU. (proinsert)	249,261
●	SOL 40P ALU.	261
●	SPACER AND LEVELING WEDGES	291
●	SPACER FOR GLASS BRICK	311
●	SPACER FOR MESH	311
●	SPACERS EXPO. DISPLAY	330
●	SQUARE SHOW CASE	324
●	STYLE STAIR ALU.	254
●	STYLE STAIR L ALU.	255
●	SUPPORT AND LEVELLER	299
●	T FORM PROFILE ALU.	282
●	TERMINAL ALU.	253
●	TERMINAL CURVE ALU.	110
●	TERMINAL PIN ALU. (proinsert)	252
●	TERMINAL PIN LVT	258
●	TROLLEY WITH SAMPLE BOARDS	326
●	TROWEL	301
●	TROWEL PVC	301
●	TUBE & ACCESSORIER	131
●	TUBE FOR RUNNERS	131
●	TUBE PLUGS/END CAPS	131
●	WATERSTOP PVC	207
●	WEDGE SHIMS	312
●	ZERO CURVE ALU. (proinsert)	250
●	ZERO CURVE LVT	258
●	ZERO CURVE SELFADHESIVE ALU.	260

## PROFILES FOR WALLS

ARTICLE	CODE	PAGE
<b>PROJOLLY SQUARE</b>		
PROJOLLY SQUARE steel	PJQSAC...	2-3
PROJOLLY SQUARE brass	PJQSOC...	5
PROJOLLY SQUARE alu.	PJQS...	6-8
PROJOLLY SQUARE pvc	PJQ...	9
<b>PROJOLLY QUART</b>		
PROJOLLY QUART steel	PJQTAC...	10
PROJOLLY QUART alu.	PJQT...	11-13
PROJOLLY QUART pvc	PJQT...	14
<b>PROJOLLY</b>		
PROJOLLY steel	PJAC...	15-16
PROJOLLY brass	PJO...	17
PROJOLLY alu.	PJ...	18-21
PROJOLLY pvc	PJ...	22
PROJOLLY MARBLE pvc	PJ...	23
PROJOLLY OPEN pvc	PJP...	23
PROJOLLY ECO pvc	PJE...	24
PROJOLLY ECO MARBLE pvc	PJE...	25
<b>PROJOLLY TRIANGLE</b>		
PROJOLLY TRIANGLE steel	PJTRAC...	26
PROJOLLY TRIANGLE brass	PJTRO...	27
PROJOLLY TRIANGLE alu.	PJTR...	28
PROJOLLY ANGLE 135 steel	PJTR135...	29
<b>PROINTER</b>		
PROINTER steel	PIAC...	30-31
PROINTER KL steel	PIKLAC...	30-31
PROINTER alu.	PI...	32
PROINTER KL brass / alu.	PIKL...	32
PROINTER pvc	PI...	33
<b>PROTERMINAL</b>		
PROTERMINAL INT alu.	PTI...	35
PROTERMINAL steel	PTAC...	16,36
PROTERMINAL brass	PTO...	37
PROTERMINAL alu.	PT...	37-39
PROTERMINAL pvc	PT...	39
<b>PROLISTEL</b>		
PROLISTEL steel	PLTAC...	40-41
PROLISTEL P alu.	PLTP...	42
PROLISTEL alu.	PLT...	43
PROLISTEL LED alu.	PLTLED	43
PROLISTEL CHANNEL alu.	PLTCH...	34
PROLISTEL CHANNEL steel	PLTCH...	34
PROLISTEL P brass	PLTP...	41
<b>PROFINLIST</b>		
PROFINLIST 20 alu.	PFLT...	44
<b>PROBORD</b>		
PROBORD steel	PEBDB...	45
<b>PROEDGE</b>		
PROEDGE FLEX	PFC...40	45
PROEDGE AC steel	PEGAC...	46
PROEDGE OT brass	PEGO...	46
PROEDGE R AC steel	PEGRAC...	47
PROEDGE R OT brass	PEGRO...	47
PROEDGE AL alu.	PEGA...	48
PROEDGE pvc	PEG...	48
<b>PROSHELL</b>		
PROSHELL steel	PSHAC...	50-51
PROSHELL alu.	PSHA...	52
<b>PROSGUSCIO</b>		
PROSGUSCIO pvc	PS...	53
<b>PROROUND</b>		
PROROUND steel	PRDAC	54
<b>PROSANI STRIP</b>		
PROSANI STRIP pvc	PSS...	54
<b>PROSEAL</b>		
PROSEAL pvc	PSA...	55-56
PROSEAL FLEX pvc	PSF...	56
<b>PROBATH</b>		
PROBATH pvc	PSB...	57
PROBATH FLEX pvc	PSBF...	57
<b>PROKERLAM</b>		
PROKERLAM LINE steel	PKLL...	58
PROKERLAM LINE alu.	PKLL...	58
<b>PROTERMSTEP</b>		
PROTERMSTEP steel	PTSPAC...	59
<b>PROTOP</b>		
PROTOP alu.	PCT...	60
PROTOP T alu.	PCT...T	60



## PROFILES FOR FLOORS

ARTICLE	CODE	PAGE
<b>PROTERMINAL</b>		
PROTERMINAL steel	PTAC...	64-65
PROTERMINAL brass	PTO...	65
PROTERMINAL alu.	PTA...	66
<b>PROLEVIGAL</b>		
PROLEVIGAL brass	PLGO...	67
PROLEVIGAL alu.	PLGAN...	67
<b>PROLEGANT</b>		
PROLEGANT brass	PELO...	68
PROLEGANT alu.	PELA...	68
<b>PROFINAL</b>		
PROFINAL steel	PRFAC...	70
PROFINAL brass	PRFO...	70
PROFINAL alu.	PRFA...	71
<b>PROSQUARE</b>		
PROSQUARE brass	PQE...	71
<b>PROANGLE</b>		
PROANGLE brass	PGAQ...	71
<b>PROJOINT</b>		
PROJOINT brass	PITO...	72
PROJOINT alu.	PITA...	72
<b>PROCANAL</b>		
PROCANAL alu./brass	PCL...	73
<b>PROFLAT</b>		
PROFLAT steel/brass	GPL...	73
<b>PROSLIDER</b>		
PROSLIDER steel	PDAC...	74
PROSLIDER brass	PDO...	74
PROSLIDER alu.	PDA...	75
PROSLIDER LR alu.	PDLRA...	75
PROSLIDER WOOD	PDWR...	76
PROSLIDER KL alu.	PKLA...	86
<b>PROCARPET</b>		
PROCARPET steel	PRTAC...	77
PROCARPET brass	PRTO...	77
PROCARPET alu.	PRTA...	78
<b>PROSKID</b>		
PROSKID alu./brass	PSLD...	78
<b>PROLEVALL</b>		
PROLEVALL 29 alu.	PLV...29	79
PROLEVALL 33 brass	PLVOL 33	79
PROLEVALL 305 steel/brass	PLV...30...	80
PROLEVALL 32 alu.	PLV...32	80
PROLEVALL 358 brass	PLVOL 358...	81
PROLEVALL 4413 alu./brass	PLVOL 4413	81
PROLEVALL 25/35/38/50 alu.	PLV...	99
<b>PRONIVO</b>		
PRONIVO alu.	PNVA...713	82
<b>PROTRANS</b>		
PROTRANS alu.	PTS... 613	82
<b>PROFLOOR</b>		
PROFLOOR 712 steel	PFRAC...712	83
PROFLOOR 712 brass	PFRAL...712	83
PROFLOOR 712 alu.	PFRA... 712	83
PROFLOOR 1216 steel/brass	PFR...1216	84
PROFLOOR 24 steel/brass	PFR...24...	85
<b>PROPRESS</b>		
PROPRESS steel/brass.	PRS...712...	84
<b>PROLINOLEUM</b>		
PROLINOLEUM alu.	PLU...16	85
<b>PROCOVER</b>		
PROCOVER 1045 alu.	PCR...1045	86
PROCOVER steel	PCRAC...	88
PROCOVER brass	PCRO...	88
PROCOVER alu.	PCR...	89
PROCOVER WOOD	PCRA...	89
PROCOVER 14PT alu.	PCR...14PT	91
<b>PROPLATE</b>		
PROPLATE steel	PETAC...	90
PROPLATE brass	PETO...	90
PROPLATE 80 ALZ alu.	PETAA...	91
<b>PROSOL</b>		
PROSOL 18-30-35-40 steel	PLSAC...	93-94
PROSOL 18-30-35-40 brass	PLSO...	95-96
PROSOL 30-35-40 alu.	PLS...	97
<b>PROMOQUETTE</b>		
PROMOQUETTE alu.	PMQ...	100
PROMOQUETTE FIX alu.	PMF...	100
PROMOQUETTE GIN alu.	PMG...	101
PROMOQUETTE CLIP alu.	PMC...	101





**● CURVE PROFILES**

ARTICLE	CODE	PAGE
<b>PROTERMINAL CURVE</b>		
PROTERMINAL CURVE steel	PTACV...	104
PROTERMINAL CURVE alu.	PTANCV...	105
PROTERMINAL CURVE brass	PTONCV...	105
<b>PROELEGANT CURVE</b>		
PROELEGANT brass	PELONCV...	107
PROELEGANT alu.	PELAACV...	107
<b>PROFINAL CURVE</b>		
PROFINAL brass	PRFONCV...	108
PROFINAL alu.	PRFAACV...	108
<b>PROJOLLY CURVE</b>		
PROJOLLY CURVE brass	PJONCV...	109
PROJOLLY CURVE alu.	PJAACV...	109
<b>TERMINAL CURVE</b>		
TERMINAL CURVE alu.	PINT..CV...	110
<b>PROCOVER</b>		
PROCOVER alu./wood	PCR...	110
<b>PROSLIDER CURVE</b>		
PROSLIDER CURVE brass	PDONCV...	111
PROSLIDER CURVE alu.	PDAACV...	111
<b>PROCURVE MACHINE</b>		
PROCURVE MACHINE	PCM 08	111

**● STAIR NOSINGS PROFILES**

ARTICLE	CODE	PAGE
<b>PROSTAIR</b>		
PROSTAIR Steel	PTRACS...	114
PROSTAIR GRIP steel	PTRGRACS...	117
PROSTAIR 50 alu.	PTR50...	119
PROSTAIR alu.	PTR...	120
PROSTAIR BOTTON/STRIP	PTRB...	121
PROSTAIR LED	PTRLEDA...	124
PROSTAIR WOOD	PTRW...	128
PROSTAIR WOOD Z	PTRWZ...	128
<b>PROSTYLE</b>		
PROSTYLE 2610	PSYACS 2610	114
PROSTYLE GRIP Steel	PSYGRACS 6020	118
PROSTYLE steel	PSYAC...	126
PROSTYLE brass	PSYO...	126
PROSTYLE alu.	PSYA...	127
PROSTYLE WOOD	PSYW...	129
<b>PROGRIP</b>		
PROGRIP	PGR...	117/137
<b>PROSTEP</b>		
PROSTEP pvc	PTP...	120
PROSTEP INS alu.	PTSA...	127
PROSTEP WOOD	PTPW...	129
<b>PROBRASTE</b>		
PROBRASTE alu./ott	PBP...	121
<b>PROTERMSTEP</b>		
PROTERMSTEP Steel	PTSPAC...	122
PROTERMSTEP Alu. alu.	PTSPA...	122
<b>PROSIDE WALK</b>		
PROSIDE WALK alu.	PSDWK...	123
<b>TUBE &amp; ACCESSORIES</b>		
TUBE	TCT...	131
TUBE FOR RUNNERS	TGS...	131
TUBE PLUGS/END CAPS	TET...	131
SUPPORT/EYELET	SO...	131
HINGE SUPPORT	SC...	131
<b>PROWALK</b>		
PROWALK Steel	PWKAC...	132
PROWALK brass/alu.	PWK...	133
PROWALK 2510/2520	PWK...25...	134
<b>PROEND</b>		
PROEND alu.	PED...	132
PROEND INS 75 alu.	PED...7537	135
PROEND INS alu.	PED 4528...	135
PROEND GRIP 70 alu.	PEGR..7032	136
PROEND 5050 alu.	PEGRAA 50	136
PROEND GRIP alu.	PEGR.. 5230	137

**● EXPANSION JOINTS**

ARTICLE	CODE	PAGE
<b>PROFLEX</b>		
PROFLEX Steel	PFXAC...	140
PROFLEX Steel PR steel	PFXACPR...	140
PROFLEX brass	PFXOT...	141
PROFLEX AL alu.	PFXAL...	141
PROFLEX ACN steel	PFXACN...	142
PROFLEX ALN alu.	PFXALN...	142
PROFLEX pvc	PFX...	144
PROFLEX 5 pvc	PFX5...	144
PROFLEX 5 PR pvc	PFX5PR...	145
PROFLEX 25 pvc	PFX25...	148
<b>PRODILAT</b>		
PRODILAT steel	GCAC...	143
PRODILAT alu.	GCAN...	143
<b>JOINTS</b>		
<b>ADHESIVE-LAID JOINT</b>		
ADHESIVE-LAID JOINT pvc	C5...	146
MORTAR-LAID JOINT steel/brass/alu.	G...	146
MORTAR-LAID JOINT pvc	C5...	147
MORTAR-LAID DOUBLE JOINT pvc	GDSP...	147
MORTAR-LAID FULL JOINT pvc	GPSP...	148
<b>PROEXPAN</b>		
PROEXPAN 115-130-190-210 alu.	PENF...	149
PROEXPAN H20-H40	PEN...	150
<b>GDA</b>		
GDA 55 alu.	GDA 55...	151
GDA 25-35 alu.	GDA ...	150
<b>FIREPROOF CORD</b>		
FIREPROOF CORD	C...	151
<b>GNS</b>		
GNS 20-50 alu.	GNS...	152
GNS 75 alu.	GNS 75...	152
<b>PROPLATE</b>		
PROPLATE FIX alu.	PETFXPAA...	153
PROPLATE FIX pvc	PETFX...	153

**● LOW THICKNESS PROFILES**

ARTICLE	CODE	PAGE
<b>PROKERLAM</b>		
PROKERLAM SQUARE alu.	PKLQ...	156
PROKERLAM JOLLY alu.	PKLJ...	156
PROKERLAM LINE alu.	PKLL...	157
PROKERLAM LINE steel	PKLL...	157
<b>PROSHELL</b>		
PROSHELL D ALL alu.	PSHD...	159
PROSHELL R ALL alu.	PSHR...	159
<b>PROINTER</b>		
PROINTER KL Steel	PIKLAC...	160
PROINTER KL ALL alu.	PIKL...	160
<b>PROSTYLE</b>		
PROSTYLE KL 10 alu.	PSYKLA 1045	161
PROSTAIR		
PROSTAIR KL 20 alu.	PTRKLA 2045	161

**● PROFILES FOR TERRACES**

ARTICLE	CODE	PAGE
<b>PROTERRACE</b>		
PROTERRACE DOUBLE DRI alu.	PDPP...	164
PROTERRACE DRAIN DRIP al.	PFDP...	165
PROTERRACE DRAIN FDP alu.	PFDP...	166
PROTERRACE ECO alu.	PTEE...	167
PROTERRACE ECO DRIP alu.	PTEDP...	167
PROTERRACE PCG Steel.	PCG...	168
PROTERRACE PCG alu.	PCG...	168
PROTERRACE PC steel	PC...	169
PROTERRACE PC alu.	PC...	169
PROTERRACE PCJ alu.	PCJ...	170
PROTERRACE PTER Steel	PTER...	169
<b>PROSIDE WALK</b>		
PROSIDE WALK alu.	PSDWK...	166
<b>WATERPROOFING</b>		
PROSHOWER DRAIN KIT	PSH...DK	171
PROSHOWER DRAIN CENTRAL PRO	PSHWCP	171
PRODRIP	PDRP	17



## MEMBRANES & PANELS

ARTICLE	CODE	PAGE
<b>PRODESO DRAIN SYSTEM</b>		
PRODESO DRAIN	PDESDR...	175
<b>PRODESO HEAT GRIP SYSTEM</b>		
PRODESO HEAT GRIP	PDESHG...	177
<b>PRODESO HEAT SYSTEM</b>		
PRODESO HEAT	PDESH...	179
PRODESO HEAT KIT	PDESHK...	180
PRODESO HEAT STICK	PDESHST...	181
<b>PRODESO ECO SYSTEM</b>		
PRODESO ECO / ECO STICK	PDESEC...	181
<b>PRODESO MEMBRANE SYSTEM</b>		
PRODESO MEMBRANE	PDES...	183
<b>PROBAND</b>		
PROBAND 150/250	PRBPE...	183
PROBAND BU	PRBBU...	184
PROBAND KOLL	PRBKL	184
PROBAND KOLL AB	PRBKLAB	184
PROBAND FIX	PRBFX...	184
PROMEMBRANE KOLL	PRMKL	184
<b>PRODRAIN 10</b>		
PRODRAIN 10	PDRI 10	186
<b>PRODESO SOUND SYSTEM</b>		
PRODESO SOUND	PDSND...	185
PRODESO SOUND TAPE	PDSNDTP...	185
<b>PROECOFON</b>		
PROECOFON	PEF...	185
<b>PROFOIL SYSTEM</b>		
PROFOIL/PROFOIL PRO	PFLO...	186
PROFOIL PASTE	PFLOPST...	186
PROFOIL CORNERS	PRB...	184, 186
<b>PROFOIL PANEL SYSTEM</b>		
PROFOIL PANEL	PFLPAN...	187
PROFOIL PANEL ACCESSORIES		187
<b>PRO GOBOARD PANEL</b>		
PRO GOBOARD PANEL	PGOBOR...	187

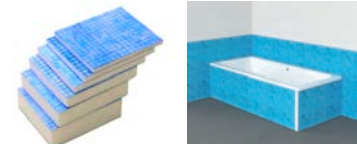
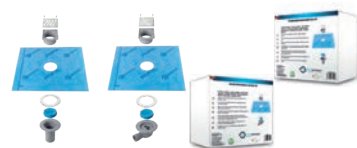
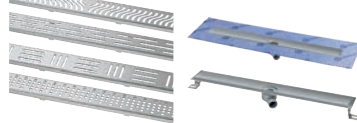
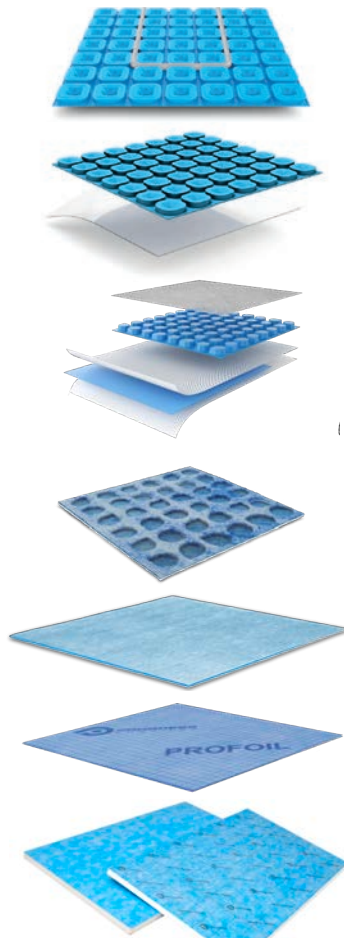

## SHOWER SYSTEMS

ARTICLE	CODE	PAGE
<b>PROSHOWER LINEAR</b>		
PROSHOWER LINEAR KIT	PSHPANEK	190
PROSHOWER PANEL LINEAR	PSHPAN	190
PROSHOWER PANEL EXTENSION	PSHPANXT...	190
<b>PROSHOWER BASE</b>		
PROSHOWER BASE L	PSHWDL...	191
PROSHOWER BASE BASIC	PSHWBB...	191
PROFOIL SECTION	PSHANT...	191
PROSHOWER BASE L PRO	PSHWP...	194
WALL DRAIN BOX	KPSHPWP...	195
<b>PROSHOWER TOP</b>		
PROSHOWER TOP	PSHW...	192
PROSHOWER TOP PRO	PSHWP...	194
<b>ACCESSORIES</b>		
DRAIN REDUCTION	PSHWRD 5040	193
MODULAR ASSEMBLY KIT	PSHWRD...	193
<b>PROSHOWER PROFILE</b>		
PROSHOWER PROFILE GLASS	PSHWPGACS...	196
PROSHOWER PROFILE	PSHWPPACS...	196
PROSHOWER PROFILE WALL	PSHWPPACS...	197
PROSHOWER PROFILE FRONT	PSHWPPACS...	197
PROLISTEL CHANNEL acc.	PLTCHAC...	198
PROLISTEL CHANNEL all.	PLTCHAA...	198
<b>PROSHOWER CENTRAL</b>		
PROSHOWER CENTRAL KIT	PSHPANCEK...	200
PROSHOWER PANEL CENTRAL	PSHPANAC	200
<b>PROSHOWER DRAIN KIT</b>		
PROSHOWER DRAIN LATERAL	PSHVDK	201
PROSHOWER DRAIN CENTRAL PRO	PSHWCP	201
<b>PROFOIL SYSTEM</b>		
PROFOIL/PROFOIL PRO	PFLO...	204
PROFOIL PASTE	PFLPST...	204
PROFOIL CORNERS	PRB...	204
PROBAND 150/250	PRBPE...	204
PROBAND FIX	PRBFX...	204
<b>PROFOIL PANEL SYSTEM</b>		
PROFOIL PANEL	PFLPAN...	202
PROFOIL PANEL NICHE	PFLPANICH...	203
PROFOIL PANEL ACCESSORIES		202
<b>PROSHELF</b>		
PROSHELF T/R	PROSHELF...	205
<b>PRO GOBOARD PANEL</b>		
PRO GOBOARD PANEL	PGBORD	205
<b>PROHEATER</b>		
PROHEATER	PHTST...	206

## SKIRTINGS BOARDS

ARTICLE	CODE	PAGE
<b>PROSKIRTING</b>		
PROSKIRTING CHANNEL	PKCHAA...	211
PROSKIRTING FLAT	PKFLAA...	211
PROSKIRTING INS	PKINSAA 60	212
PROSKIRTING LINE	PKLIAA 60	212
PROSKIRTING ISP	PKISPA...	213
PROSKIRTING LIST 40-80	PKLT...	214-215
PROSKIRTING LED	PKLEDA...	217
PROSKIRTING GILED	PKGLEDA...	219
PROSKIRTING 40-80	PKAA...	220
PROSKIRTING SHELL	PKSHAA 70	221
<b>SKIRTING</b>		
SKIRTING 40 steel	BTAC... 40	224
SKIRTING 40 alu.	BTA... 40	225
SKIRTING 60 steel	BTAC... 60	226
SKIRTING 60 alu.	BTA... 60	227
SKIRTING 80 steel	BTAC... 80	228
SKIRTING 80 alu.	BTA... 80	229
SKIRTING 100/150 steel	BTAC...	230
SKIRTING 100 alu.	BTA...100	231
SKIRTING 7016	BTEPR...7016	234
SKIRTING 7011	BTEPR...7011	235
SKIRTING 40 pvc	BTEPR...4010	235
SKIRTING pvc	BTPR...70	228
SKIRTING 60/120 pvc	BTPV...	236
CORNER pvc	AGE...25	237
SKIRTING 62F pvc	BTPF... 62A	238
SKIRTING COVECAP	BTVCC...	238
<b>PROMULTISKIRT</b>		
PROMULTISKIRT SQUARE	BTEPR..S	232
PROMULTISKIRT ROUND	BTEPR..R	233
<b>PROCAP S</b>		
PROCAP S	PRCP...	239
<b>PROSEAL WOOD</b>		
PROSEAL WOOD	PSAW...20	238
<b>PROANGLE WOOD</b>		
PROANGLE WOOD	PGAW...15	238



## PROFILES FOR WOOD

ARTICLE	CODE	PAGE
<b>PROMULTIFIX SYSTEM</b>		
PROMULTIFIX	PMPFX...	245
<b>PROINSERT SYSTEM</b>		
SOL 40P	PISPC...	249
ZERO CURVE	PINZC...	250
TERMINAL PIN	PINTPC...	252
STYLE STAIR	PINVC...	254
STYLE STAIR L	PINYLC...	255
PROINSERT PROFILES (top)		272
PROINSERT ACCESSORIES		273
<b>LVT</b>		
SOL 30P	PISPC...	266
ZERO CURVE	PINZC...	266
TERMINAL PIN	PINTPC...	266
LVT PROFILES (top)		279
<b>AUTOADHESIVE</b>		
SOL 30	PINS...A	268
ZERO CURVE	PINZ...A	268
SOL 40 P	PNSP...A	269
<b>PROCOVER</b>		
PROCOVER WOOD	PCRA...	261
PROCOVER INSERT	PCPCR...	261
<b>PROFIXER LINE SYSTEM</b>		
ZERO CURVE	PINZ...	262
SOL 30/40/50	PINS/PNSP...	263
PROFIXER LINE ACCESSORIES		263
<b>PROSCREW</b>		
PROSCREW 34/44/33/50	PSWC...	264
PROSCREW ACCESSORIES		264
<b>SKIRTING</b>		
PROMULTISKIRT SQUARE	BTEPR...S	266
PROMULTISKIRT ROUND	BTEPR...R	267
SKIRTING 7016	BTEPR 7016	268
SKIRTING 7011	BTEPR 7011	269
SKIRTING 40 pvc	BTEPR 4010	269
SKIRTING pvc	BTPR...70	271
PROSEAL WOOD	PSAW...20	270
PROANGLE WOOD	PGAW...15	270
CORNED	AGE...25	271
TERMINAL	PINT...	261
PROWALK 2510/2520	PWK...	261
PROSTEP INS	PTSAA...	253

● DO IT YOURSELF

ARTICLE	CODE	PAGE
CORNER EQUAL SIDES steel	AGAC...	276
CORNER EQUAL SIDES brass	AGOL...	276
CORNER EQUAL SIDES alum.	AGA...	276
CORNER EQUAL SIDES pvc	AGP...	277
CORNER "L-form" alum.	AL...	277
CORNER "L-form" pvc	ALP...	277
CANAL "U-form" alum.	CU...	278
CANAL DOUBLE "U-form" alum.	CW...	278
FLAT alu.	PI...	279
FLAT brass.	PI...	279
EMPTY ROUND TUBE alum.	TV...	280
FULL ROUND TUBE alum.	TP...	280
EMPTY SQUARE TUBE alum.	TQV...	281
FULL SQUARE TUBE alum.	TQP...	280
EMPTY RECTANGULAR TUBE alum.	TR...	281
CURVE PROFILES alum.	UG...	281
PROFILE "T-form" alum.	T...	282
CURTAINBLACE alum.	CT...	282
IRON		275

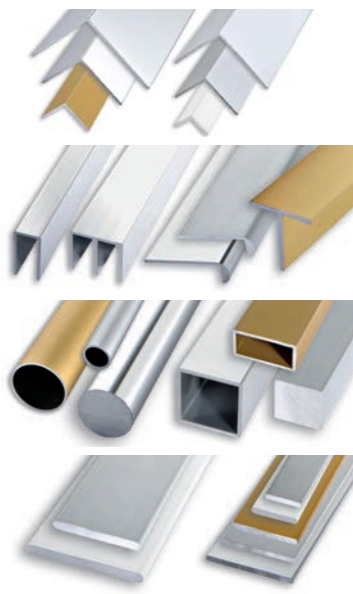

● PRODUCTS FOR LAYING

ARTICLE	CODE	PAGE
<b>PROLEVELING SYSTEM</b>		
PROLEVELING SYSTEM	PRS...	289
PROLEVELING WEDGE SYSTEM	PRLW...	290
<b>MULTISPACER</b>		
MULTISPACER	MSP...	291
<b>SPACERS &amp; LEVELLERS</b>		
SPACERS	R...	291
LEVELING WEDGES	PCU...	291
<b>PROSUPPORT TUBE SYSTEM</b>		
PROSUPPORT TUBE SYSTEM	PST...	292
PERIMETRAL SPACER	DPP	294
ADJUSTING KEY	PSTAK	294
ADJUSTABLE SPACER	PSTJ	294
FIXING CLIP	PSTWP	294
RUBBER DISK	LVGG02	294
SPACER FOR GRAVEL APPLICATION	DILV	294
<b>PRORAIL SYSTEM</b>		
PRORAIL SYSTEM	PSTR...	296
<b>PROSUPPORT SLIM SYSTEM</b>		
PROSUPPORT SLIM SYSTEM	PSTSL...	298
<b>SUPPORT &amp; LEVELLER</b>		
SUPPORT & LEVELLER	SQG...	299
<b>PROSUPPORT PROFILE</b>		
PROSUPPORT PROFILE T	PSPRPT...	295
PROSUPPORT PROFILE N	PSTRP...	295
PROSUPPORT PROFILE A&B	PPFSAL...	295
<b>ACCESORIES</b>		
MAGNET KIT	KMD	300
SCISSORS FOR PVC PROFILES	FTPP	300
PROCOFON	PEF...	300
PROBAND FIX	PRBFX...	300
PROPOLISH	PRLISH	300
PROCARE CLEAN	PRCLEAN	300
TROWEL	PFTT...	301
PVC TROWEL	PRSPD 10	301
ROLLER	PSM	301



● BUILDINGS SYSTEM

ARTICLE	CODE	PAGE
SNAP-ON STRAND SHEAT pvc	R...	304
SNAP-ON STRAND SHEAT TUBE pvc	R...	304
FINNED DISTANCE TUBE pvc	TDA...	304
END CAPS FOR DISTANCE TUBE	PPT...	304
RIBBED DISTANCE TUBE pvc	PPD...	305
DRIP pvc	GCT...	305
TRIANGULAR CHAMFER PROFILE pvc	PST...	306

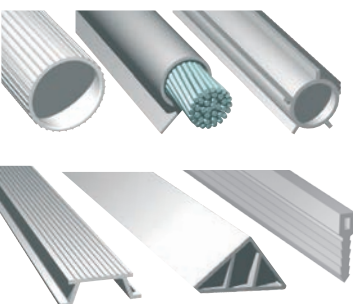

ROUNDED TRIANGULAR CHAMFER pvc	PSD...	306
FISHBONE RIBBED JOINT pvc	GRP...	306
PROFILE WITH DOUBLE CHAMFER	R...	306
WATERSTOP	WP...	307
PRODISTANZ	PDZ...	308
RAPI 100	PLF...	309
RAPI 100 ECO	PLFE...	309
RAPI 200	PLF...R...	309
MULTIPIEDE	DMP...	309
SPACER "PAV"	PPV...	310
SPACER "PAU"	PPU...	310
Spacers FOR VERTICAL / HORIZONTAL MESH	DVO...	311
Spacers FOR GLASS BRICK	DSVT	311
SPACER "DOPPY"	PPY...	311
PROTECTIVE CAPS	PCPF...	312
FLAT SPACER	PPN...	312
WEDGE SHIMS	SAC...	312
SPACER "PAV"	PPX...	313
SPACER "PAL"	PPO...	313
SPACER "PAS"	PPS...	313
GASKETS FOR PRECAST FORMS	M...	314
GAP-COVERING BALLON SHEATH	C 550...	319
PAVIJOINT	PVJ...	320
SHEAT LAYING TROLLEY	CPGC...	321

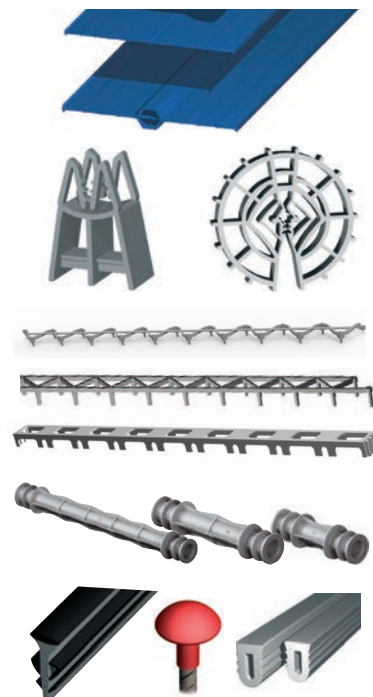

● MARKETING

ARTICLE	CODE	PAGE
SQUARE SHOW CASE	ESQPC...	324
EXPOSURE WALL	ESHPAN 250	325
ROTATING EXPOSURE STAND	ESPGSM 18	326
SMALL EXPOSURE STAND	CURAS	326
TROLLEY	TRAG18	326
EXP. PROLISTEL & SKIRTING	ESPBLSH	326
SAMPLE BOARDS	PESP...	327
FINISHES CASES	COF...	328
COLOR RANGE	COL...	328
PROINSERT SAMPLES	TUBLAM	328
PROSKIRTING LED DISPLAY	ESPLED	328
PROSKIRTING GILED DISPLAY	ESPGLED	328
EXP. PRODESO HEAT	ESPDPH1595	329
EXP. PRODESO HEAT	ESPCPDES...	329
EXP. PRODESO MEMBRANE	ESPCPDES...	329
MEMBRANE CASE	CPFM...	329
EXP. SYSTEMS	ESPDPHT...	329
EXP. PROSHOWER	ESPSPHW 70	329
EXP. PROLEVELING	ESPPLS...	330
PROLEVELING DISPLAY	PNPLS...	330
PROLEVELING WEDGE DISP.	PNPLWS...	330
EXP. DISTANZIATORI	ESPD	330
EXP. PROTERRACE	ESPDPDP	330
EXP. PROSUPPORT TUBE	ESPST	330
PRODUCTS DISPLAY	PNPSPR...	330
CATALOGUE	CAT...	331
BROCHURE PROSHOWER	BRPSP...	331
BRO. PRODESO HEAT GRIP	BRPDESHG	331
BRO. PRODESO HEAT	BRPDESH...	331
BRO. PRODESO MEMBRANE	BRPDES...	331
BRO. PROSUPPORT TUBE	BRPSUP...	331
BRO. PRODESO DRAIN	BRPDDR...	331
BROCHURE SISTEMI	BRYS...	331
PHOTO BOOK	BOAM...	331
MINI CATALOGUE	MCAT...	331
MINI CATALOGUE EXP.	ESPB...	331
FLYER	FLY...	331
FLYER EXP.	PBPLS...	331
MODULAR DISPLAY SYSTEM		332
SHOWROOM PROPOSALS		334
PROFILES EXPOSURE DISPLAY		336
MEMBRANE EXPOSURE DISPLAY	PEM	337
GADGETS		339
TECHNICAL CLOTHING		339





An interpretation of:  
**Unicredit Tower, César Pelli &  
Vertical Forest, Stefano Boeri Architetti, MILAN (Italy), 2014**

PROFILES FOR WALLS

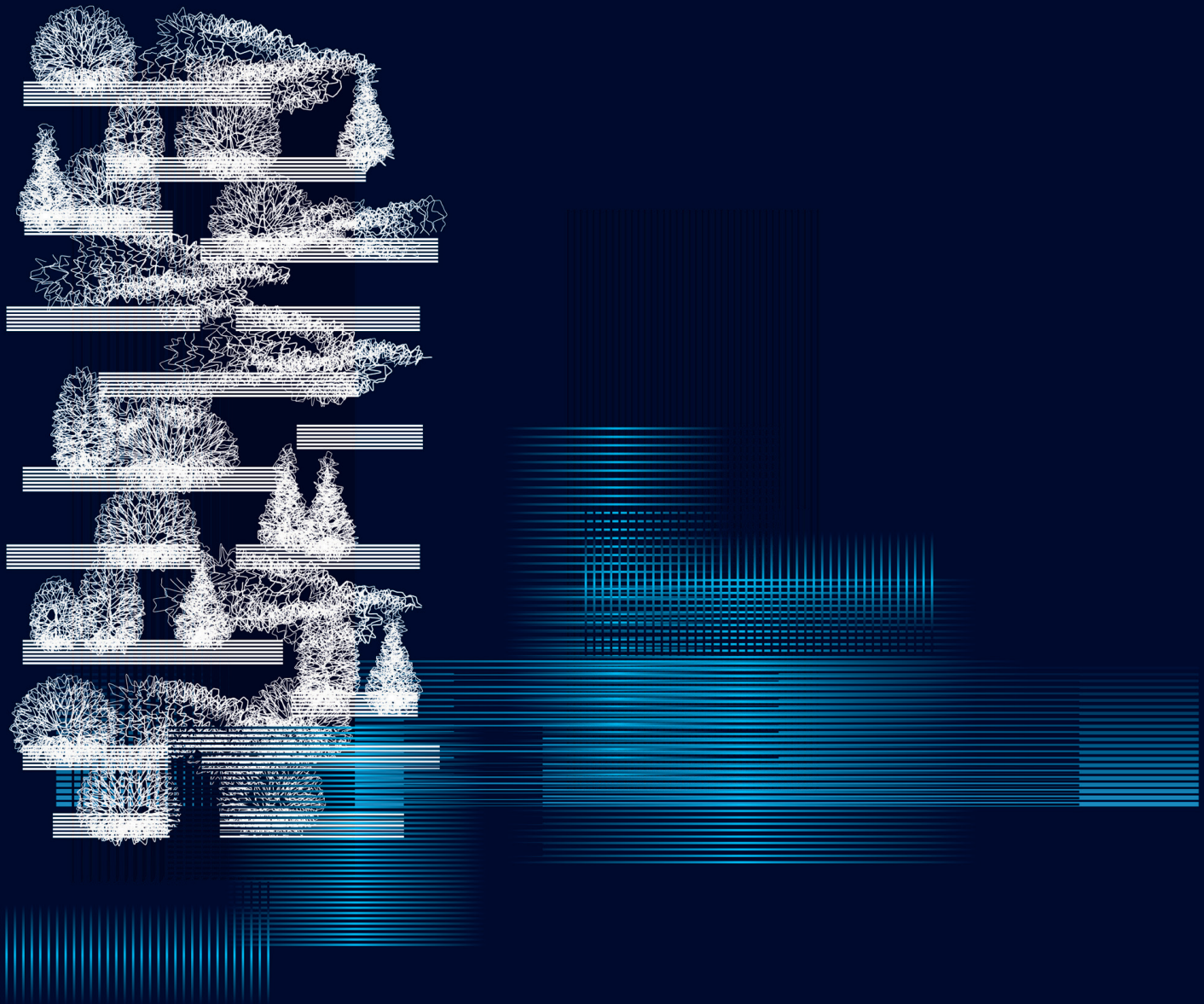

# PROJOLLY SQUARE

POLISHED, SUPER POLISHED, SANDED AND BRUSHED STAINLESS STEEL AISI 304/1.4301-V2A

**PROJOLLY SQUARE** is a square corner bead profile in polished, super polished, sanded, brushed stainless steel AISI 304/1.4301-V2A that can be applied on external corners of coverings. It can be used to close the perimeter of coverings, like a connection profile between step tread and riser of stairs coated with ceramic and natural stone tiles, and also as separation profile for floor and wall coverings. Its particular section, the availability in three different finishes and special pieces such as internal and external corners, end caps and joints make **PROJOLLY SQUARE** a much sought-after profile that allows a workmanlike application even in environments subject to high mechanical stresses.

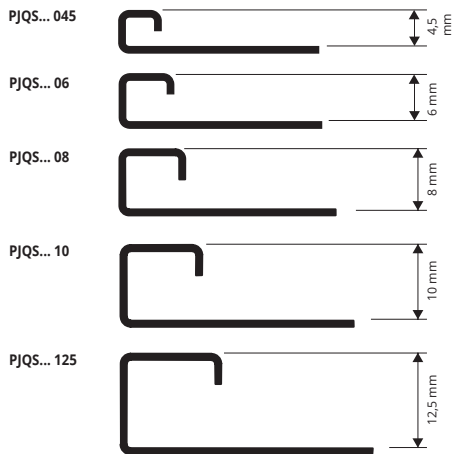

PJQSAC/S 11 & PJQSACML 11 AVAILABLE H 11 MM  
PJQSAC/S 15 & PJQSACML 15 AVAILABLE H 15 MM

## EXAMPLES AND INSTRUCTIONS FOR LAYING METHODS

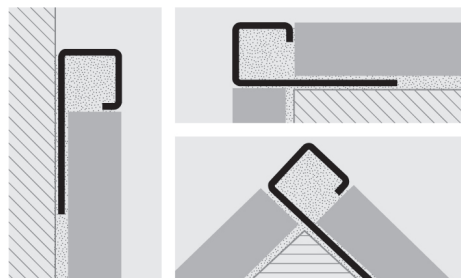

1. Choose "PROJOLLY SQUARE" according to the tile thickness and desired finish.
2. Cut "PROJOLLY SQUARE" to the desired length and apply the adhesive on the support where the profile will be laid.
3. Press the anchoring flange of "PROJOLLY SQUARE" into the adhesive.
4. Lay the tiles, aligning them with the profile leaving a 2 mm joint. Remove immediately all remains of adhesive from the surface of the profile.
5. Fill the joints between the profile and the tiles with grout, in order to avoid water stagnation. Remove immediately all the remains of grout from the surface of the profile.



POLISHED STAINLESS STEEL AISI 304/1.4301-V2A with protective film  
bar length 2,7 lm - Pack 20 Pcs - 54 lm (H 4,5 - 108 lm) - 8/10 mm

Article	H mm
PJQSAC 045	4,5
PJQSAC 06	6
PJQSAC 07	7
PJQSAC 08	8
PJQSAC 09	9
PJQSAC 10	10
PJQSAC 11	11
PJQSAC 125	12,5
PJQSAC 15	15

SUPER POLISHED STAINLESS STEEL AISI 304/1.4301-V2A  
thermo Packed

bar length 2,7 lm - Pack 20 Pcs - 54 lm - 8/10 mm

Article	H mm
PJQSACML 045	4,5
PJQSACML 06	6
PJQSACML 07	7
PJQSACML 08	8
PJQSACML 09	9
PJQSACML 10	10
PJQSACML 11	11
PJQSACML 125	12,5
PJQSACML 15	15

SUITABLE FOR USE IN CONTACT WITH FOODSTUFFS.



Brushed STAINLESS ST. AISI 304/1.4301-V2A with protective film  
bar length 2,7 lm - Pack 20 Pcs - 54 lm (H 4,5 - 108 lm) - 8/10 mm

Article	H mm
PJQSACS 045	4,5
PJQSACS 06	6
PJQSACS 07	7
PJQSACS 08	8
PJQSACS 09	9
PJQSACS 10	10
PJQSACS 11	11
PJQSACS 125	12,5
PJQSACS 15	15

SANDED STAINLESS STEEL AISI 304/1.4301-V2A with protective film  
bar length 2,7 lm - Pack 20 Pcs - 54 lm - 8/10 mm

Article	H mm
PJQSACSB 07	7
PJQSACSB 08	8
PJQSACSB 09	9
PJQSACSB 10	10
PJQSACSB 125	12,5

## COLOURS



AC - Polished S.S. AISI 304/1.4301-V2A ACML - Super poli S.S. AISI 304/1.4301-V2A

ACS - Brushed s.s. AISI 304/1.4301-V2A ACSB - Sanded s.s. AISI 304/1.4301-V2A

# CAPSULES, END CAPS and THREE-WAYS JOINTS

POLISHED, SUPER POLISHED, SATIN AND SANDED FINISH ST. STEEL AISI 304/1.4301-V2A / PLASTIC

\* Capsules & end caps of the on demand profiles are also on demand

## CAPSULES and END CAPS - POLISHED STAINLESS STEEL AISI 304/1.4301-V2A

Article	H mm	Pack 10 Pcs	Pack 2 Pcs
CPJQSAC .../...	045/06/07/08/09/ 10/11/125/15		
TPJQSAC .../...	045/06/07/08/09/ 10/11/125/15		

Choose the desired pack. & height  
Ex.: 4,5 mm capsule in 10 Pcs Pack - CPJQSAC 045/10

## CAPSULES AND END CAPS - BRUSHED STAINLESS ST. AISI 304/1.4301-V2A

Article	H mm	Pack 10 Pcs	Pack 2 Pcs
CPJQSACS .../...	045/06/07/08/09/ 10/11/125/15		
TPJQSACS .../...	045/06/07/08/09/ 10/11/125/15		

Choose the desired pack. & height  
Ex.: 4,5 mm capsule in 10 Pcs Pack - CPJQSACS 045/10

## CAPSULES - SUPER POLISHED STAINLESS STEEL AISI 304/1.4301-V2A

Article	H mm	Pack 10 Pcs	Pack 2 Pcs
CPJQSACML .../...	045/06/07/08/09/ 10/11/125/15		
TPJQSACML .../...	045/06/07/08/09/ 10/11/125/15		

Choose the desired pack. & height  
Ex.: 4,5 mm capsule in 10 Pcs Pack - CPJQSACML 045/10

## CAPSULES and END CAPS - SANDED STAINLESS STEEL AISI 304/1.4301-V2A

Article	H mm	Pack 10 Pcs	Pack 2 Pcs
CPJQSACSB .../...	07/08/09 10/125		
TPJQSACSB .../...	07/08/09 10/125		

Choose the desired pack. & height  
Ex.: 8 mm capsule in 10 Pcs Pack - CPJQSACSB 08/10

## JOINTS - PLASTIC

Article	H mm	Pack 10 Pcs	Pack 2 Pcs
GIJQ .../...	045/06/07/08/09/ 10/11/125/15		

Choose the desired pack. & height  
Ex.: 4,5 mm joint in 10 Pcs Pack - GIJQ 045/10

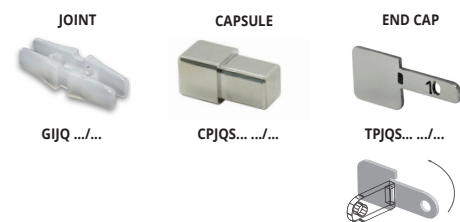
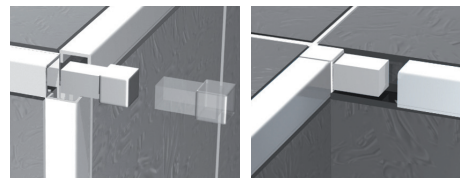

News 2022

\* = Production on demand with minimum quantity of 100 pcs. Production delay 4/5 weeks. Price to be agreed

**PROJOLLY SQUARE** is a square corner bead profile in polished stainless steel AISI 304/1.4301-V2A that can be applied on external corners of coverings. It can be used to close the perimeter of coverings, like a connection profile between step tread and riser of stairs coated with ceramic and natural stone tiles, and also as separation profile for floor and wall coverings. Its particular section and the availability of special pieces such as internal and external corners, end caps and joints make **PROJOLLY SQUARE** a much sought-after profile that allows a workmanlike application even in environments subject to high mechanical stresses.

# PROJOLLY SQUARE

POLISHED, BRUSHED STAINLESS STEEL  
AISI 316LL/1.4404-V4A



**POLISHED STAINLESS STEEL AISI 316LL/1.4404-V4A**  
with protective film  
bar length 2,7 LM - Pack 20 Pcs - 54 lm - 8/10 mm



Article	H mm		
PJQSACM 08	8		*
PJQSACM 10	10		
PJQSACM 11	11		
PJQSACM 125	12,5		

#### COLOURS



**BRUSHED STAINLESS STEEL AISI 316LL/1.4404-V4A**  
with protective film  
bar length 2,7 LM - Pack 20 Pcs - 54 lm - 8/10 mm



Article	H mm		
PJQSACMS 10	10		*
PJQSACMS 11	11		*
PJQSACMS 125	12,5		*

#### COLOURS

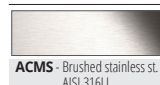

SUITABLE FOR USE IN CONTACT WITH FOODSTUFFS.

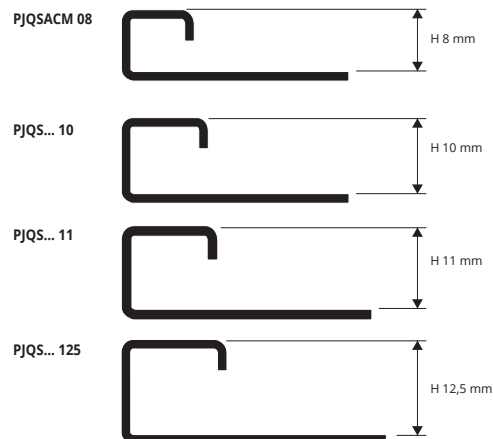

#### INSTRUCTIONS FOR LAYING METHODS

1. Choose "PROJOLLY SQUARE" according to the tile thickness and desired finish. 2. Cut "PROJOLLY SQUARE" to the desired length and apply the adhesive on the support where the profile will be laid. 3. Press the anchoring flange of "PROJOLLY SQUARE" into the adhesive. 4. Lay the tiles, aligning them with the profile leaving a 2 mm joint. Remove immediately all remains of adhesive from the surface of the profile. 5. Fill the joints between the profile and the tiles with grout, in order to avoid water stagnation. Remove immediately all the remains of grout from the surface of the profile.

## CAPSULES, END CAPS and THREE-WAYS JOINTS

STAINLESS STEEL AISI 316LL

Capsules & end caps of the on demand profiles are also on demand \*

CAPSULES and END CAPS - POLISHED STAINLESS STEEL AISI 316LL/1.4404

Article	H mm	Pack 10 Pcs	Pack 2 Pcs
CPJQSACM .../...	08/10/11/12,5		
TPJQSACM .../...	08/10/11/12,5		

Choose the desired pack. & height  
Ex.: 10 mm capsule in 10 Pcs PACMk - CPJQSACM 10/10

CAPSULES and END CAPS - BRUSHED STAINLESS STEEL AISI 316LL/1.4404

Article	H mm	Pack 10 Pcs	Pack 2 Pcs
CPJQSACMS .../...	10/11/125		
TPJQSACMS .../...	10/11/125		

Choose the desired pack. & height  
Ex.: 10 mm capsule in 10 Pcs PACMk - CPJQSACMS 10/10

JOINTS - PLASTIC

Article	H mm	Pack 10 Pcs	Pack 2 Pcs
GIJQ .../...	08/10/11/125		

Choose the desired pack. & height  
Ex.: 8 mm joint in 10 Pcs Pack - GIJQ 08/10

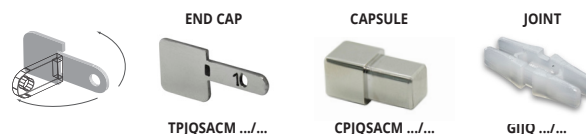

\* = Production on demand with minimum quantity of 100 pcs. Production delay 4/5 weeks. Price to be agreed





**PROJOLLY SQUARE** is a square corner bead profile in chromed brass or antique brass that can be applied on external corners of coverings. It can be used to close the perimeter of coverings, like a connection profile between step tread and riser of stairs coated with ceramic and natural stone tiles, and also as separation profile for floor and wall coverings. Its particular section and elegance and the availability of special pieces such as internal and external corners, end caps and joints make **PROJOLLY SQUARE** a much sought-after profile that allows an elegant workmanlike application.

# PROJOLLY SQUARE

CHROMED BRASS, BRUSHED AND ANTIQUE BRASS



**CHROMED BRASS thermo Packed**  
bar length 2,7 lm - Pack 20 Pcs - 54 lm

Article	H mm		
PJQSOC 045	4,5		
PJQSOC 06	6		
PJQSOC 08	8		
PJQSOC 10	10		
PJQSOC 125	12,5		



**BRUSHED BRASS thermo Packed**  
bar length 2,7 lm - Pack 20 Pcs - 54 lm

Article	H mm		
* PJQSOS 045	4,5		*
* PJQSOS 06	6		*
* PJQSOS 08	8		*
* PJQSOS 10	10		*
* PJQSOS 125	12,5		*

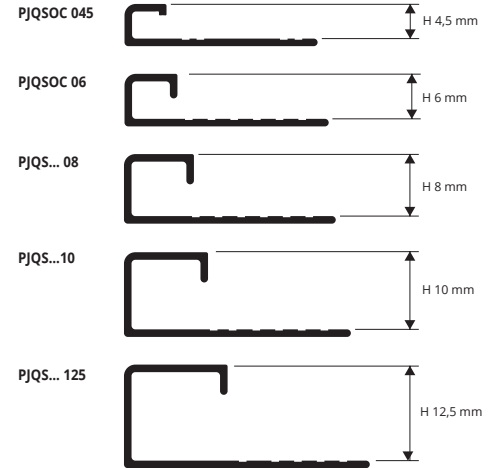

**ANTIQUÉ BRASS thermo Packed** bar length 2,7 lm  
Pack 20 Pcs - 54 lm (PJQSOB 125 - Pack 10 Pcs)

Article	H mm		
PJQSOB 08	8		
PJQSOB 10	10		
PJQSOB 125	12,5		

### INSTRUCTIONS FOR LAYING

1. Choose "PROJOLLY SQUARE" according to the tile thickness.
2. Cut "PROJOLLY SQUARE" to the desired length and apply the adhesive on the support where the profile will be laid.
3. Press the anchoring flange of "PROJOLLY SQUARE" into the adhesive.
4. Lay the tiles, aligning them with the profile leaving a 2 mm joint. Remove immediately all remains of adhesive from the surface of the profile.
5. Fill the joints between the profile and the tiles with grout, in order to avoid water stagnation. Remove immediately all the remains of grout from the surface of the profile.

### EXAMPLES OF LAYING

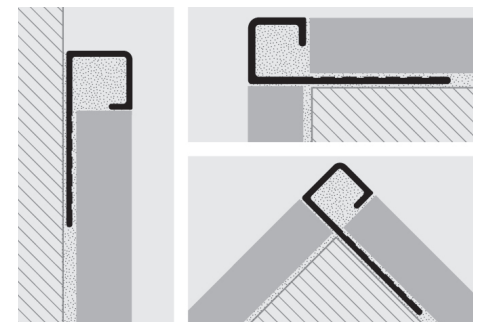

### COLOURS



## CAPSULES, END CAPS and THREE-WAYS JOINTS

CHROMED BRASS - PLASTIC

Capsules & end caps of the on demand profiles are also on demand \*

### CAPSULES and END CAPS - CHROMED BRASS

Article	H mm	Pack 10 Pcs	Pack 2 Pcs
CPJQSOC .../...	045/06/08/10/125		
TPJQSOC .../...	045/06/08/10/125		

Choose the desired pack. & height  
Ex.: 10 mm capsule in 10 Pcs Pack - CPJQSOS 10/10

### CAPSULES and END CAPS - ANTIQUE BRASS

Article	H mm	Pack 10 Pcs	Pack 2 Pcs
CPJQSOB .../...	08/10/125		
TPJQSOB .../...	08/10/125		

Choose the desired pack. & height  
Ex.: 10 mm capsule in 10 Pcs Pack - CPJQSOS 10/10

### CAPSULES and END CAPS - BRUSHED BRASS

Article	H mm	Pack 10 Pcs	Pack 2 Pcs
CPJQSOS .../...	045/06/08/10/125		
TPJQSOS .../...	045/06/08/10/125		

Choose the desired pack. & height  
Ex.: 10 mm capsule in 10 Pcs Pack - CPJQSOS 10/10

### JOINTS - PLASTIC

Article	H mm	Pack 10 Pcs	Pack 2 Pcs
GIJQ .../...	045/06/08/10/125		

Choose the desired pack. & height  
Ex.: 8 mm joint in 10 Pcs Pack - GIJQ 08/10

#### JOINT



GIJQ .../...

#### CAPSULE



CPJQSOC .../...

#### END CAP



TPJQSOC .../...

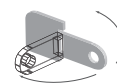

# PROJOLLY SQUARE

ANODIZED AND POLISHED ALUMINIUM

**PROJOLLY SQUARE** is a square corner bead profile in anodized and polished aluminium that can be applied on external corners of coverings. It can be used to close the perimeter of coverings, like a connection profile between step tread and riser of stairs coated with ceramic and natural stone tiles and also as separation profile for floor and wall coverings. Its particular section and elegance, the availability in eight finishes and special pieces such as internal and external corners, end caps and joints make **PROJOLLY SQUARE** a much sought-after profile that allows an elegant workmanlike application.

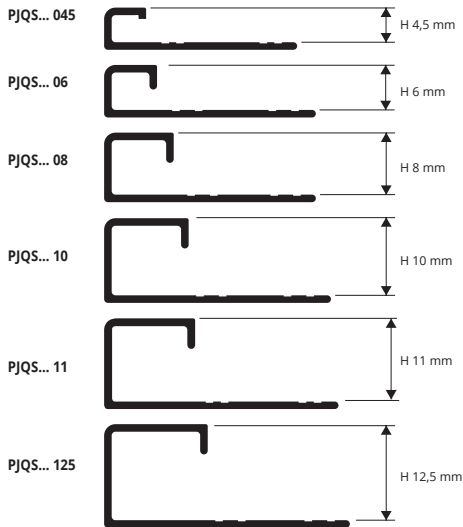

**ANODIZED ALUMINIUM thermo Packed** (silver-gold-copper-titanium-black)  
bar length 2,7 lm - Pack 40 Pcs - 108 lm (H 12,5 mm - Pack 20 Pcs - 54 lm)



**POLISHED ALUMINIUM thermo Packed** (chrome-gold-titanium-copper-black)  
bar length 2,7 lm - Pack 40 Pcs - 108 lm (H 12,5 mm - Pack 20 Pcs - 54 lm)

Article	H mm		
PJQSAA 045	4,5		*
PJQSAA 06	6		
PJQSAA 08	8		
PJQSAA 10	10		
PJQSAA 11	11		
PJQSAA 125	12,5		
PJQSAO 08	8		*
PJQSAO 10	10		*
PJQSAO 125	12,5		*
PJQSAR 045	4,5		*
PJQSAR 06	6		
PJQSAR 08	8		
PJQSAR 10	10		
PJQSAR 125	12,5		
PJQSAT 045	4,5		*
PJQSAT 06	6		
PJQSAT 08	8		
PJQSAT 10	10		
PJQSAT 11	11		
PJQSAT 125	12,5		
PJQSNE 08	8		
PJQSNE 10	10		
PJQSNE 11	11		
PJQSNE 125	12,5		

Article	H mm		
PJQSBC 045	4,5		*
PJQSBC 06	6		
PJQSBC 08	8		
PJQSBC 10	10		
PJQSBC 11	11		
PJQSBC 125	12,5		
PJQSBO 08	8		*
PJQSBO 10	10		*
PJQSBO 125	12,5		*
PJQSBR 045	4,5		*
PJQSBR 06	6		
PJQSBR 08	8		*
PJQSBR 10	10		*
PJQSBR 125	12,5		*
PJQSBT 045	4,5		*
PJQSBT 06	6		
PJQSBT 08	8		
PJQSBT 10	10		
PJQSBT 11	11		
PJQSBT 125	12,5		
PJQSBN 08	8		
PJQSBN 10	10		
PJQSBN 11	11		
PJQSBN 125	12,5		

## EXAMPLES AND INSTRUCTIONS FOR LAYING METHODS

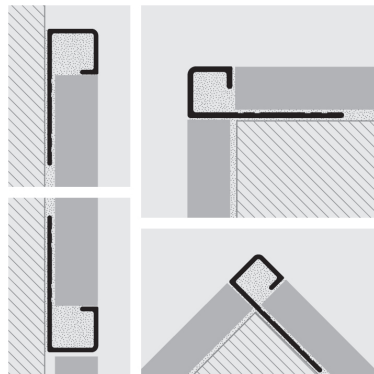

1. Choose "PROJOLLY SQUARE" according to the tile thickness and desired finish. 2. Cut "PROJOLLY SQUARE" to the desired length and apply the adhesive on the support where the profile will be laid. 3. Press the anchoring flange of "PROJOLLY SQUARE" into the adhesive. 4. Lay the tiles, aligning them with the profile leaving a 2 mm joint. Remove immediately all remains of adhesive from the surface of the profile. 5. Fill the joints between the profile and the tiles with grout, in order to avoid water stagnation. Remove immediately all the remains of grout from the surface of the profile.

## COLOURS

ANODIZED				
AA - Anod. silver alum.	AO - Anod. gold alum.	AR - Anod. copper alum.	AT - Anod. titanium alum.	NE - Anod. black alum.
POLISHED				
BC - Pol. chrome alum.	BO - Pol. gold alum.	BR - Pol. copper alum.	BT - Pol. titanium alum.	BN - Pol. black alum.

# CAPSULES, END CAPS and THREE-WAYS JOINTS

\* Capsules & end caps of the on demand profiles are also on demand

ANODIZED AND POLISHED ALUMINIUM / PLASTIC

## CAPSULES and END CAPS - ANODIZED ALUMINIUM

Article	H mm	Pack 10 Pcs	Pack 2 Pcs
CPJQSAA .../...	045/06/08/10/11/125		
TPJQSAA .../...	045/06/08/10/11/125		
CPJQSAO .../...	8/10/125		
TPJQSAO .../...	8/10/125		
CPJQSAR .../...	045/06/08/10/125		
TPJQSAR .../...	045/06/08/10/125		
CPJQSAT .../...	045/06/08/10/11/125		
TPJQSAT .../...	045/06/08/10/11/125		
CPJQSNE .../...	08/10/11/125		
TPJQSNE .../...	08/10/11/125		

Choose the desired pack. & height  
Ex.: 10 mm capsule in 10 Pcs Pack - CPJQSAA 10/10

## CAPSULES and END CAPS - POLISHED ALUMINIUM

Article	H mm	Pack 10 Pcs	Pack 2 Pcs
CPJQSBC .../...	045/06/08/10/11/125		
TPJQSBC .../...	045/06/08/10/11/125		
CPJQSBO .../...	8/10/125		
TPJQSBO .../...	8/10/125		
CPJQSBR .../...	045/06/08/10/125		
TPJQSBR .../...	045/06/08/10/125		
CPJQSBT .../...	045/06/08/10/11/125		
TPJQSBT .../...	045/06/08/10/11/125		
CPJQSBN .../...	08/10/11/125		
TPJQSBN .../...	08/10/11/125		

Choose the desired pack. & height  
Ex.: 10 mm capsule in 10 Pcs Pack - CPJQSBC 10/10

## JOINTS - PLASTIC

Article	H mm	Pack 10 Pcs	Pack 2 Pcs
GIJQ .../...	045/06/08/10/11/125		

Choose the desired pack. & height  
Ex.: 8 mm joint in 10 Pcs Pack - GIJQ 08/10

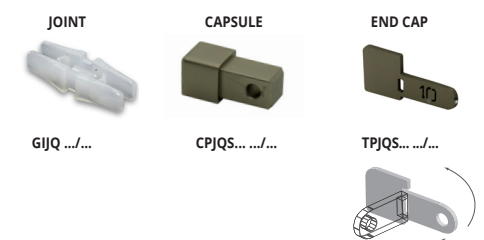

\* = Production on demand with minimum quantity of 100 pcs. Production delay 4/5 weeks. Price to be agreed

**PROJOLLY SQUARE** is a square corner bead profile in brushed and tiltex aluminium that can be applied on external corners of coverings. It can be used to close the perimeter of coverings, like a connection profile between step tread and riser of stairs coated with ceramic and natural stone tiles and also as separation profile for floor and wall coverings. Its particular section and elegance, the availability in eight finishes and special pieces such as internal and external corners, end caps and joints make **PROJOLLY SQUARE** a much sought-after profile that allows an elegant workmanlike application.

# PROJOLLY SQUARE

BRUSHED POLISHED AND ANODIZED BRUSHED TILTEX ALUMINIUM



**BRUSHED POLISHED ALUM. thermo Packed** (silver-gold-copper titanium-black) bar length 2,7 lm - Pack 40 Pcs - 108 lm (H 12,5 mm - Pack 20 Pcs - 54 lm)

Article	H mm		
PJQSBS 045	4,5		*
PJQSBS 06	6		
PJQSBS 08	8		
PJQSBS 10	10		
PJQSBS 11	11		
PJQSBS 125	12,5		
PJQSRS 045	4,5		*
PJQSRS 06	6		
PJQSRS 08	8		
PJQSRS 10	10		
PJQSRS 125	12,5		
PJQSTS 045	4,5		*
PJQSTS 06	6		
PJQSTS 08	8		
PJQSTS 10	10		
PJQSTS 11	11		
PJQSTS 125	12,5		
PJQSBOS 08	8		
PJQSBOS 10	10		
PJQSBOS 125	12,5		
PJQSBRAS 10	10		*
PJQSBRAS 125	12,5		*
PJQSNS 08	8		
PJQSNS 10	10		
PJQSNS 11	11		
PJQSNS 125	12,5		

**ANOD. BRUSHED TILTEX ALUM. thermo Packed** (silver-copper-titanium) - bar length 2,7 lm - Pack 40 Pcs - 108 lm (H 12,5 mm - Pack 20 Pcs - 54 lm)

Article	H mm		
PJQSBX 06	6		
PJQSBX 08	8		
PJQSBX 10	10		
PJQSBX 11	11		
PJQSBX 125	12,5		
PJQSRX 06	6		
PJQSRX 08	8		
PJQSRX 10	10		
PJQSRX 125	12,5		
PJQSTX 06	6		
PJQSTX 08	8		
PJQSTX 10	10		
PJQSTX 11	11		
PJQSTX 125	12,5		

## COLOURS

BRUSHED POLISHED		
BS - Br. polish, silver alum.	BOS - Br. polish, gold alum.	RS - Br. polish, copper alum.
TS - Br. polish, titanium alum.	NS - Br. polish, black alum.	BRAS - Br. polish, antique bronze alum.
ANOD. BRUSHED TILTEX		
BX - Silver TILTEX	RX - Copper TILTEX	TX - Titanium TILTEX

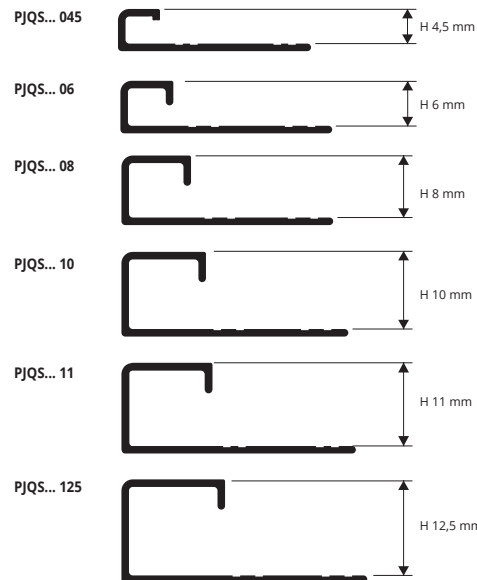

## EXAMPLES AND INSTRUCTIONS FOR LAYING METHODS

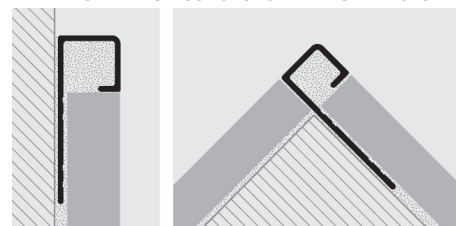

1. Choose "PROJOLLY SQUARE" according to the tile thickness and desired finish. 2. Cut "PROJOLLY SQUARE" to the desired length and apply the adhesive on the support where the profile will be laid. 3. Press the anchoring flange of "PROJOLLY SQUARE" into the adhesive. 4. Lay the tiles, aligning them with the profile leaving a 2 mm joint. Remove immediately all remains of adhesive from the surface of the profile. 5. Fill the joints between the profile and the tiles with grout, in order to avoid water stagnation. Remove immediately all the remains of grout from the surface of the profile.

## CAPSULES, END CAPS and THREE-WAYS JOINTS

ANODIZED BRUSHED POLISHED ALUMINIUM, TILTEX / PLASTIC

Capsules & end caps of the on demand profiles are also on demand \*

### CAPSULES and END CAPS - BRUSHED POLISHED ALUMINIUM

Article	H mm	Pack 10 Pcs	Pack 2 Pcs
CPJQSBS .../...	045/06/08/10/11/125		
TPJQSBS .../...	045/06/08/10/11/125		
CPJQSRS .../...	045/06/08/10/125		
TPJQSRS .../...	045/06/08/10/125		
CPJQSTS .../...	045/06/08/10/11/125		
TPJQSTS .../...	045/06/08/10/11/125		
CPJQSBOS .../...	08/10/125		
TPJQSBOS .../...	08/10/125		
CPJQSBRAS .../...	10/125		
TPJQSBRAS .../...	10/125		
CPJQSNS .../...	08/10/11/125		
TPJQSNS .../...	08/10/11/125		

Choose the desired pack. & height  
Ex.: 10 mm capsule in 10 Pcs Pack - CPJQSBS 10/10

### CAPSULES and END CAPS - ANODIZED BRUSHED TILTEX ALUMINIUM

Article	H mm	Pack 10 Pcs	Pack 2 Pcs
CPJQSBX .../...	06/08/10/11/125		
TPJQSBX .../...	06/08/10/11/125		
CPJQSRX .../...	06/08/10/125		
TPJQSRX .../...	06/08/10/125		
CPJQSTX .../...	06/08/10/11/125		
TPJQSTX .../...	06/08/10/11/125		

Choose the desired pack. & height  
Ex.: 10 mm capsule in 10 Pcs Pack - CPJQSBX 10/10

### JOINTS - PLASTIC

Article	H mm	Pack 10 Pcs	Pack 2 Pcs
GIJQ .../...	045/06/08/10/11/125		

Choose the desired pack. & height  
Ex.: 8 mm joint in 10 Pcs Pack - GIJQ 08/10

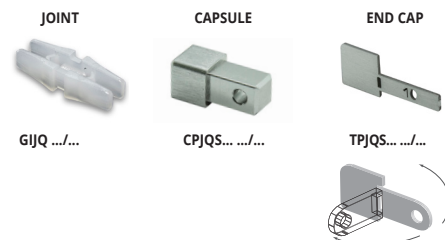

\* = Production on demand with minimum quantity of 100 pcs. Production delay 4/5 weeks. Price to be agreed

# PROJOLLY SQUARE

ALUMINIUM STONE LINE, VARNISHED ALUMINIUM AND TUSCANY LINE

**PROJOLLY SQUARE** is a corner bead profile in powder coated aluminum that can be applied on external corners of coverings. It can be used to close the perimeter of coverings. Its particular section and the availability of several finishes and special pieces such as internal and external corners, junctions and end caps make **PROJOLLY SQUARE** an elegant and much-sought after profile. workmanlike application.

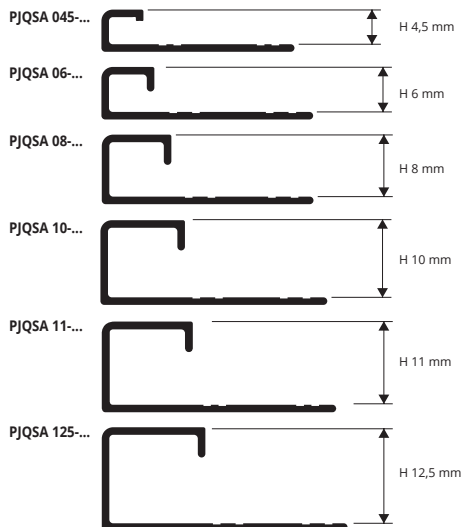

**STONE LINE thermo Packed**  
bar length 2,7 lm - Pack 20 Pcs-54 lm

Article	H mm
PJQSA 06-SL...	6
PJQSA 08-SL...	8
PJQSA 10-SL...	10
PJQSA 11-SL...	11
PJQSA 125-SL...	12,5

Available in the colours: SL01 - SL02 - SL03 - SL04 - SL05 - SL06 - SL07 - SL08 - SL09 - SL10 - SL11 - SL12 - SL13.

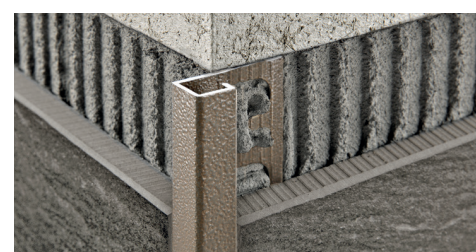

**TUSCANY LINE thermo Packed**  
bar length 2,7 lm - Pack 40 Pcs- 108 lm (H 12,5 mm - Pack 20 Pcs)

Article	H mm
PJQSA 08-...	8
PJQSA 10-...	10
PJQSA 125-...	12,5

Available in the colours: 03TU - 05TU - 20TU.  
The code of the selected colour must be added to the article code.  
E.g.: PJQA 08-... (chosen colour tuscan grey) PJQA 08-03TU.

## EXAMPLES AND INSTRUCTIONS FOR LAYING METHODS

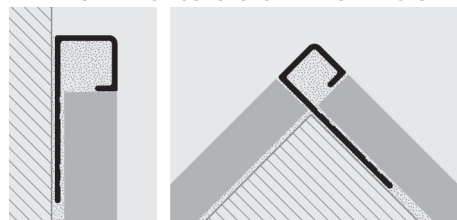

1. Choose "PROJOLLY SQUARE" according to the tile thickness and desired finish. 2. Cut "PROJOLLY SQUARE" to the desired length and apply the adhesive on the support where the profile will be laid. 3. Press the anchoring flange of "PROJOLLY SQUARE" into the adhesive. 4. Lay the tiles, aligning them with the profile leaving a 2 mm joint. Remove immediately all remains of adhesive from the surface of the profile. 5. Fill the joints between the profile and the tiles with grout, in order to avoid water stagnation. Remove immediately all the remains of grout from the surface of the profile.

**WHITE VARNISHED ALUMINIUM thermo Packed**  
bar length 2,7 lm - Pack 20 Pcs - 54 lm (white colour 40 Pcs-108 lm)

Article	H mm
PJQSA 045-01	4,5
PJQSA 08-01	8
PJQSA 10-...	10
PJQSA 11-01	11
PJQSA 125-01	12,5

Available in the colours: 01 - 0106 - 02 - 11. Available on demand 010 - 03 - 0211 - 0311 - 06 - 10 - 17 with a minimum quantity order of 100 pcs.

## COLOURS

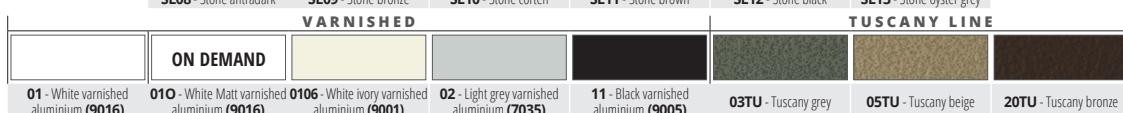

AVAILABLE MINIMUM QUANTITY 100 PCS by colour and height (Price to be agreed. Production delay 4/5 weeks)

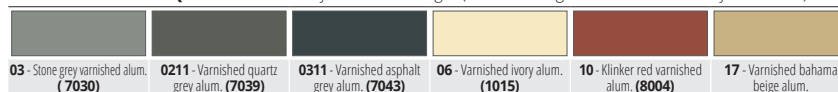

# CAPSULES, END CAPS and THREE-WAYS JOINTS

ALUMINIUM STONE LINE, TUSCANY LINE AND VARNISHED ALUMINIUM / PLASTIC

\* Capsules & end caps of the on demand profiles are also on demand

## CAPSULES and END CAPS - STONE LINE

Article	H mm	Pack 10 Pcs	Pack 2 Pcs
CPJQSA ...-SL.../...	06/08/10/11/12,5		
TPJQSA ...-SL.../...	06/08/10/11/12,5		

Choose the desired pack & height  
Ex.: 10 mm capsule in 10 Pcs Pack - CPJQSA 10-SL01/10

## CAPSULES and END CAPS - VARNISHED

Article	H mm	Pack 10 Pcs	Pack 2 Pcs
CPJQSA ...-.../...	045/08/10/11/125		
TPJQSA ...-.../...	045/08/10/11/125		

Choose the desired pack & height  
Ex.: 10 mm capsule in 10 Pcs Pack - CPJQSA 10-03/10

## CAPSULES and END CAPS - TUSCANY LINE

Article	H mm	Pack 10 Pcs	Pack 2 Pcs
CPJQSA ...-...TU/...	08/10/125		

Choose the desired pack & height  
Ex.: 10 mm capsule in 10 Pcs Pack - CPJQSA 10-03/10

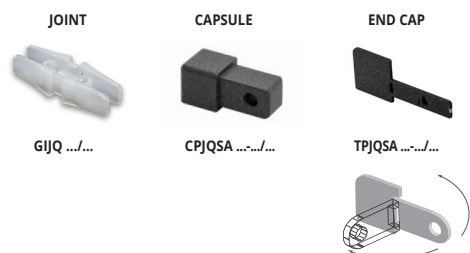

## JOINTS - PLASTIC

Article	H mm	Pack 10 Pcs	Pack 2 Pcs
GIJQ .../...	045/06/08/10/11/125		

Choose the desired pack & height  
Ex.: 8 mm joint in 10 Pcs Pack - GIJQ 08/10

**PROJOLLY SQUARE** is a square corner bead profile in shockproof non - toxic colored vinyl resin that can be applied on external corners of coverings. It can be used to close the perimeter of coverings. Its particular section, the availability in different colours also on demand and special pieces such as internal and external corners make **PROJOLLY SQUARE** a much sought-after profile. It can be easily matched with the wall covering and that allows an elegant workmanlike application.

# PROJOLLY SQUARE

SHOCKPROOF NON - TOXIC COLORED VINYL RESIN



**NON-TOXIC SHOCKPROOF VINYL RESIN**  
bar length 2,7 lm - Pack 20 Pcs - 54 lm (white colour 40 Pcs-108 lm)

Article	H mm
PJQ 06-...	6
PJQ 08-...	8
PJQ 10-...	10
PJQ 125-...	12,5

H 6 mm available the colours 01, other colours on demand.  
Available in the colours: 00-01-0106-03-06-12-17. On demand 02-04-05-07-08-09-10-11-13-14-15-16-18-19-20-21-22-23-24-25-26-27-28-29 with a minimum quantity order of 800 pcs.  
The code of the selected colour must be added to the article code.  
E.g.: PJQ 08-... (chosen colour white) PJQ 08-01.

**WHITE NOT FOR SALE SINGLY**

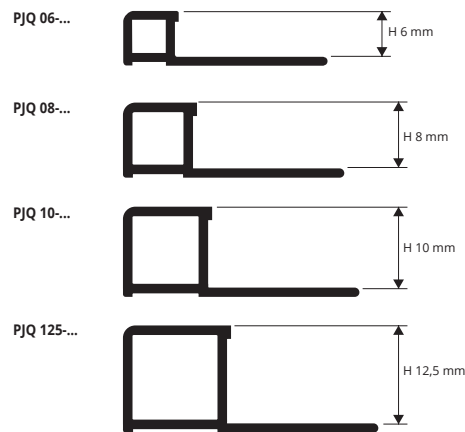

## EXAMPLES AND INSTRUCTIONS FOR LAYING METHODS

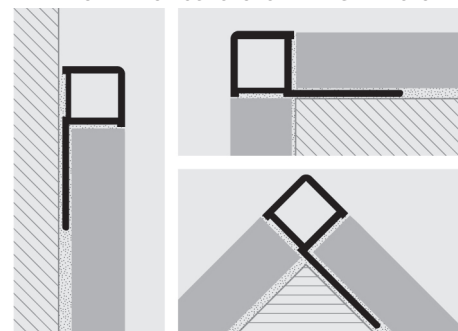

1. Choose "PROJOLLY SQUARE" according to the tile thickness and desired colour. 2. Cut "PROJOLLY SQUARE" to the desired length and apply the adhesive on the support where the profile will be laid. 3. Press the anchoring flange of "PROJOLLY SQUARE" into the adhesive. 4. Lay the tiles, aligning them with the profile leaving a 2 mm joint. Remove immediately all remains of adhesive from the surface of the profile. 5. Fill the joints between the profile and the tiles with grout, in order to avoid water stagnation. Remove immediately all the remains of grout from the surface of the profile.

## COLOURS

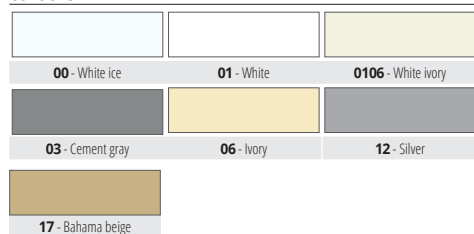

**AVAILABLE MINIMUM QUANTITY 800 PCS** by colour and height (Price to be agreed. Production delay 4/5 weeks)



## CAPSULES and THREE-WAYS JOINTS

POLYPROPYLENE / POLYETYLENE UV RESISTANT

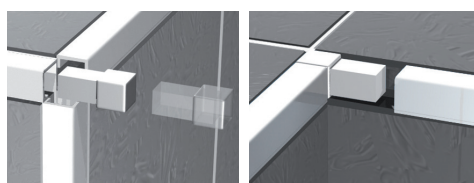

### INTERNAL CAPSULES POLYPROPYLENE/POLYETYLENE

Article	H mm	Pack 20 Pcs	Pack 5 Pcs
IPJQ 06-.../...	6		
IPJQ 08-.../...	8		
IPJQ 10-.../...	10		
IPJQ 125-.../...	12,5		

### EXTERNAL CAPSULES POLYPROPYLENE/POLYETYLENE

Article	H mm	Pack 20 Pcs	Pack 5 Pcs
CPJQ 06-.../...	6		
CPJQ 08-.../...	8		
CPJQ 10-.../...	10		
CPJQ 125-.../...	12,5		

H 6 mm available the colours 01, other colours on demand.  
Available in the colours: 00-01-0106-03-06-12-17. On demand 02-04-05-07-08-09-10-11-13-14-15-16-18-19-20-21-22-23-24-25-26-27-28-29  
The code of the selected colour must be added to the article code.  
E.g.: CPJQ 08-.../... (chosen colour white) CPJQ 08-01/20.  
IPJQ 08-.../... (chosen colour white) IPJQ 08-01/20.

### INTERNAL CAPSULES



### EXTERNAL CAPSULES



# PROJOLLY QUART

POLISHED, SUPER POLISHED AND BRUSHED STAINLESS STEEL AISI 304/1.4301-V2A

**PROJOLLY QUART** is a quarter-circle rounded bead profile in polished, super polished and brushed stainless steel AISI 304/1.4301-V2A that can be applied on external corners of coverings. It can be used to close the perimeter of coverings and like a connection profile between step tread and riser of stairs coated with ceramic or natural stone tiles. Its particular section, the availability in three different finishes and special pieces such as internal and external corners, end caps and joints make **PROJOLLY QUART** a much sought-after profile that allows a workmanlike application even in environments subject to high mechanical stresses.

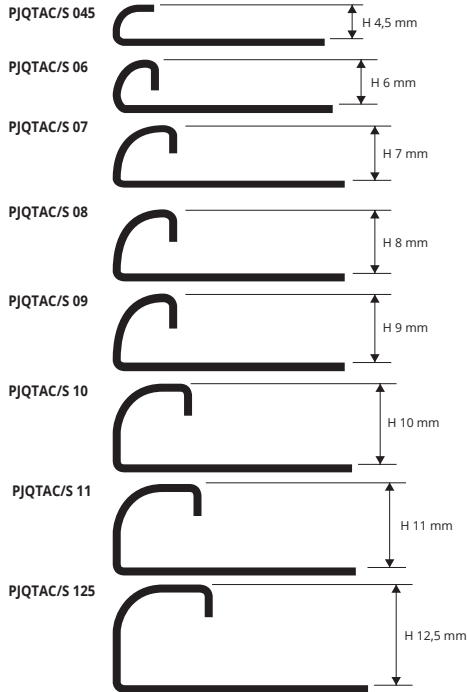

## EXAMPLES FOR LAYING METHODS

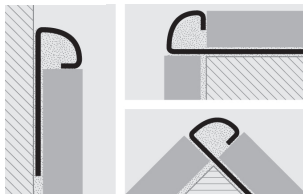

POLISHED STAINLESS STEEL AISI 304/1.4301-V2A with protective film bar length 2,7 lm - pack. 20 Pcs - 54 lm (H 4,5 mm - 108 lm) - 10/10 mm

Article	H mm		
PJQTAC 045	4,5		
PJQTAC 06	6		
☉ PJQTAC 07	7		
PJQTAC 08	8		
☉ PJQTAC 09	9		
PJQTAC 10	10		
PJQTAC 11	11		
PJQTAC 125	12,5		

SUPER POLISHED STAINLESS STEEL AISI 304/1.4301-V2A thermo packed bar length 2,7 lm - pack. 20 Pcs 54 lm (H 4,5 mm - 108 ml) - 10/10 mm

Article	H mm		
PJQTACML 045	4,5		
PJQTACML 06	6		
☉ PJQTACML 07	7		
PJQTACML 08	8		
☉ PJQTACML 09	9		
PJQTACML 10	10		
PJQTACML 11	11		
PJQTACML 125	12,5		



Brushed STAINLESS ST. AISI 304/1.4301-V2A with protective film bar length 2,7 lm - pack. 20 Pcs - 54 lm (H 4,5 mm - 108 lm) - 10/10 mm

Article	H mm		
PJQTACS 045	4,5		
PJQTACS 06	6		
☉ PJQTACS 07	7		
PJQTACS 08	8		
☉ PJQTACS 09	9		
PJQTACS 10	10		
PJQTACS 11	11		
PJQTACS 125	12,5		

## COLOURS

AC - Polished stainless st. AISI 304/1.4301-V2A	ACML - Super polished stainless st. AISI 304/1.4301-V2A	ACS - Brushed stainless st. AISI 304/1.4301-V2A

SUITABLE FOR USE IN CONTACT WITH FOODSTUFFS.

## INSTRUCTIONS FOR LAYING METHODS

1. Choose "PROJOLLY QUART" according to the tile thickness and desired finish.
2. Cut "PROJOLLY QUART" to the desired length and apply the adhesive on the support where the profile will be laid.
3. Press the anchoring flange of "PROJOLLY QUART" into the adhesive.
4. Lay the tiles, aligning them with the profile leaving a 2 mm joint. Remove immediately all remains of adhesive from the surface of the profile.
5. Fill the joints between the profile and the tiles with grout, in order to avoid water stagnation. Remove immediately all the remains of grout from the surface of the profile.

# CAPSULES, END CAPS and THREE-WAYS JOINTS

\* Capsules & end caps of the on demand profiles are also on demand

POLISHED, SUPER POLISHED AND BRUSHED STAINLESS ST. AISI 304/1.4301-V2A / PLASTIC

## CAPSULES and END CAPS - POLISHED STAINLESS ST. AISI 304/1.4301-V2A

Article	H mm	Pack 10 Pcs	Pack 2 Pcs
CPJQTAC 045/...	4,5		
IPJQTAC 045/...	4,5		
CPJQTAC 06/...	6		
IPJQTAC 06/...	6		
☉ CPJQTAC 07/...	7		
☉ IPJQTAC 07/...	7		
CPJQTAC 08/...	8		
IPJQTAC 08/...	8		
☉ CPJQTAC 09/...	9		
☉ IPJQTAC 09/...	9		
CPJQTAC 10/...	10		
IPJQTAC 10/...	10		
CPJQTAC 11/...	11		
IPJQTAC 11/...	11		
CPJQTAC 125/...	12,5		
IPJQTAC 125/...	12,5		
TPJQTAC 045-06-08-10-11-125-.../...			

Choose the desired packaging: E.g.: CPJQTAC .../10 (Pack. 10 Pcs) CPJQTAC .../2 (Pack. 2 Pcs)

## CAPSULES and END CAPS - BRUSHED STAINLESS ST. AISI 304/1.4301-V2A

Article	H mm	Pack 10 Pcs	Pack 2 Pcs
CPJQTACS 045/...	4,5		
IPJQTACS 045/...	4,5		
CPJQTACS 06/...	6		
IPJQTACS 06/...	6		
☉ CPJQTACS 07/...	7		
☉ IPJQTACS 07/...	7		
CPJQTACS 08/...	8		
IPJQTACS 08/...	8		
☉ CPJQTACS 09/...	9		
☉ IPJQTACS 09/...	9		
CPJQTACS 10/...	10		
IPJQTACS 10/...	10		
CPJQTACS 11/...	11		
IPJQTACS 11/...	11		
CPJQTACS 125/...	12,5		
IPJQTACS 125/...	12,5		
TPJQTACS 045-06-08-10-11-125-.../...			

Choose the desired packaging: E.g.: CPJQTACS .../10 (Pack. 10 Pcs) CPJQTACS .../2 (Pack. 2 Pcs)

## CAPSULES - SUPER POLISHED STAINLESS ST. AISI 304/1.4301-V2A

Article	H mm	Pack 10 Pcs	Pack 2 Pcs
CPJQTACML 045/...	4,5		
IPJQTACML 045/...	4,5		
CPJQTACML 06/...	6		
IPJQTACML 06/...	6		
☉ CPJQTACML 07/...	7		
☉ IPJQTACML 07/...	7		
CPJQTACML 08/...	8		
IPJQTACML 08/...	8		
☉ CPJQTACML 09/...	9		
☉ IPJQTACML 09/...	9		
CPJQTACML 10/...	10		
IPJQTACML 10/...	10		
CPJQTACML 11/...	11		
IPJQTACML 11/...	11		
CPJQTACML 125/...	12,5		
IPJQTACML 125/...	12,5		

Choose the desired packaging: E.g.: CPJQTACML .../10 (Pack. 10 Pcs) CPJQTACML .../2 (Pack. 2 Pcs)

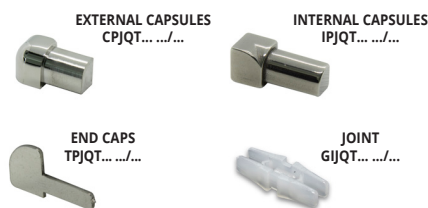

☉ = News 2021

\* = Production on demand with minimum quantity of 100 pcs. Production delay 4/5 weeks. Price to be agreed

**PROJOLLY QUART** is a quarter-circle rounded bead profile in anodized and polished aluminium that can be applied on external corners of coverings. It can be used to close the perimeter of coverings and like a connection profile between step tread and riser of stairs coated with ceramic and natural stone tiles. Its particular section and elegance, the availability in four finishes and special pieces such as internal and external corners, end caps and joints make **PROJOLLY QUART** a much sought-after profile that allows an elegant workmanlike application.

# PROJOLLY QUART

ANODIZED AND POLISHED ALUMINIUM



**ANODIZED ALUMINIUM** (silver-titanium-gold-antique bronze) thermo packed bar length 2,7 lm - pack. 40 Pcs - 108 lm (H 12,5 mm, 15 mm - pack. 20 Pcs)

**POLISHED ALUMINIUM** (chrome-titanium-gold) thermo packed - bar length 2,7 lm - pack. 40 Pcs - 108 lm (H 15 mm - 54 lm) - (H 12,5 mm, 15 mm - pack. 20 Pcs)

Article	H mm		
PJQTAA 06	6		
PJQTAA 08	8		
PJQTAA 10	10		
PJQTAA 11	11		
PJQTAA 125	12,5		
PJQTAA 15	15		
PJQTAO 06	6		
PJQTAO 08	8		
PJQTAO 10	10		
PJQTAO 11	11		
PJQTAO 125	12,5		
PJQTAT 08	8		
PJQTAT 10	10		
PJQTAT 11	11		
PJQTAT 125	12,5		
PJQTBRA 10	10		
PJQTBRA 125	12,5		

Article	H mm		
PJQTBC 06	6		
PJQTBC 08	8		
PJQTBC 10	10		
PJQTBC 11	11		
PJQTBC 125	12,5		
PJQTBC 15	15		
PJQTBO 06	6		
PJQTBO 08	8		
PJQTBO 10	10		
PJQTBO 11	11		
PJQTBO 125	12,5		
PJQTBO 15	15		
PJQBT 08	8		
PJQBT 10	10		
PJQBT 11	11		
PJQBT 125	12,5		

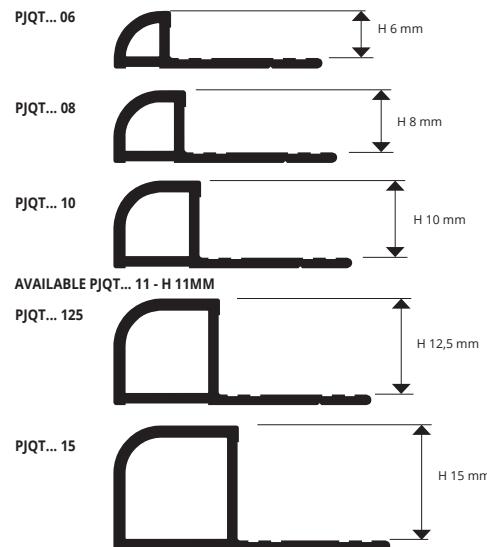

## EXAMPLES AND INSTRUCTIONS FOR LAYING METHODS

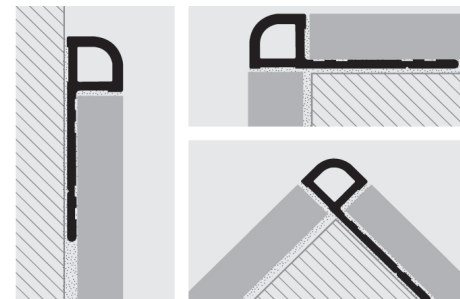

1. Choose "PROJOLLY QUART" according to the tile thickness and desired finish.
2. Cut "PROJOLLY QUART" to the desired length and apply the adhesive on the support where the profile will be laid.
3. Press the anchoring flange of "PROJOLLY QUART" into the adhesive.
4. Lay the tiles, aligning them with the profile leaving a 2 mm joint. Remove immediately all remains of adhesive from the surface of the profile.
5. Fill the joints between the profile and the tiles with grout, in order to avoid water stagnation. Remove immediately all the remains of grout from the surface of the profile.

## COLOURS

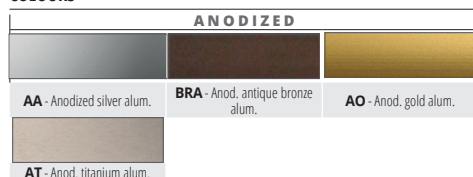

ON DEMAND MAY BE REALISED IN OTHER FINISHES OF THE COLOUR CHART.  
 CONTACT OUR CUSTOMER SERVICE FOR MINIMUM QUANTITY, TIMING AND PRICE.

# CAPSULES, END CAPS and THREE-WAYS JOINTS

ANODIZED, POLISHED ALUMINIUM / PLASTIC

Capsules & end caps of the on demand profiles are also on demand \*

## CAPSULES and END CAPS - ANODIZED ALUMINIUM

Article	H mm	Pack 10 Pcs	Pack 2 Pcs
CPJQTAA .../...	06/08/10/ 11/125/15		
IPJQTAA .../...	06/08/10/ 11/125/15		
TPJQTAA .../...	06/08/10/ 11/125/15		
CPJQTAO .../...	06/08/10/ 11/125		
IPJQTAO .../...	06/08/10/ 11/125		
TPJQTAO .../...	06/08/10/ 11/125		
CPJQTAT .../...	08/10/11/125		
IPJQTAT .../...	08/10/11/125		
TPJQTAT .../...	08/10/11/125		
CPJQTBRA .../...	10/125		
IPJQTBRA .../...	10/125		
TPJQTBRA .../...	10/125		

## CAPSULES and END CAPS - POLISHED ALUMINIUM

Article	H mm	Pack 10 Pcs	Pack 2 Pcs
CPJQTBC .../...	06/08/10/ 11/125/15		
IPJQTBC .../...	06/08/10/ 11/125/15		
TPJQTBC .../...	06/08/10/ 11/125/15		
CPJQTBO .../...	06/08/10/ 11/125		
IPJQTBO .../...	06/08/10/ 11/125		
TPJQTBO .../...	06/08/10/ 11/125		
CPJQBT .../...	08/10/11/125		
IPJQBT .../...	08/10/11/125		
TPJQBT .../...	08/10/11/125		

Choose the desired pack. & height  
 Ex.: 4,5 mm capsule in 10 Pcs Pack - CPJQTBC 10/10

## JOINTS - PLASTIC

Article	H mm	Pack 10 Pcs	Pack 2 Pcs
GIJQT .../...	06/08/10/ 11/125/15		

Choose the desired pack. & height  
 Ex.: 10 mm joint in 10 Pcs Pack - GIJQT 10/10

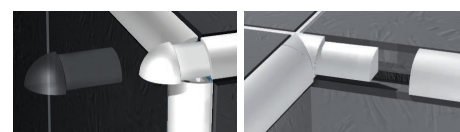

EXTERNAL CAPSULES  
 CPJQT... /...

INTERNAL CAPSULES  
 IPJQT... /...



END CAP  
 TPJQT... /...



JOINT  
 GIJQT... /...



Choose the desired pack. & height  
 Ex.: 4,5 mm capsule in 10 Pcs Pack - CPJQTAA 10/10

\* = Production on demand with minimum quantity of 100 pcs. Production delay 4/5 weeks. Price to be agreed

# PROJOLLY QUART

BRUSHED POLISHED, BRUSHED AND VARNISHED ALUMINIUM

**PROJOLLY QUART** is a quarter-circle rounded bead profile in brushed and varnished aluminium that can be applied on external corners of coverings. It can be used to close the perimeter of coverings and (only brushed version) like a connection profile between step tread and riser of stairs coated with ceramic and natural stone tiles. Its particular section and elegance, the availability in three finishes and special pieces such as internal and external corners, end caps and joints make **PROJOLLY QUART** a much sought-after profile that allows an elegant workmanlike application.

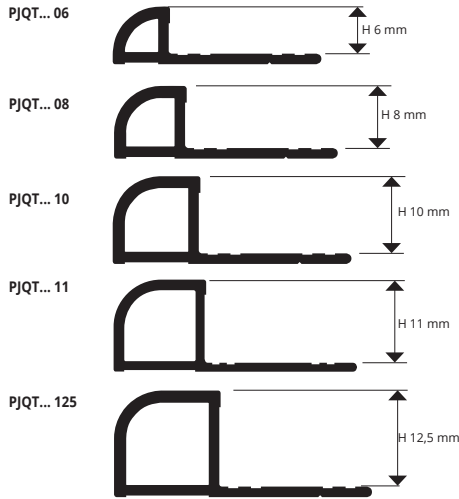

## EXAMPLES AND INSTRUCTIONS FOR LAYING METHODS

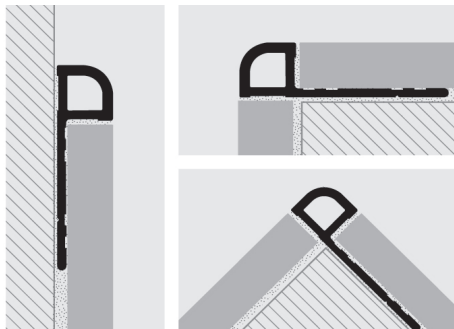

1. Choose "PROJOLLY QUART" according to the tile thickness and desired finish.
2. Cut "PROJOLLY QUART" to the desired length and apply the adhesive on the support where the profile will be laid.
3. Press the anchoring flange of "PROJOLLY QUART" into the adhesive.
4. Lay the tiles, aligning them with the profile leaving a 2 mm joint. Remove immediately all remains of adhesive from the surface of the profile.
5. Fill the joints between the profile and the tiles with grout, in order to avoid water stagnation. Remove immediately all the remains of grout from the surface of the profile.



**BRUSHED POLISHED ALUMINIUM thermo packed**  
bar length 2,7 lm - pack. 40 Pcs - 108 lm (H 12,5 mm, 15 mm - pack. 20 Pcs)

Article	H mm
PJQTBS 08	8
PJQTBS 10	10
PJQTBS 11	11
PJQTBS 125	12,5
PJQTBS 08	8
PJQTBS 10	10
PJQTBS 11	11
PJQTBS 125	12,5

**BRUSHED ANTIQUE BRONZE ALUMINIUM thermo packed**  
bar length 2,7 lm - pack. 40 Pcs - 108 lm (H 12,5 mm, 15 mm - pack. 20 Pcs)

Article	H mm
PJQTBAS 10	10
PJQTBAS 125	12,5

## COLOURS



## ON DEMAND MINIMUM QUANTITY 100 PCS



**BOS** - Brushed gold alum.

(Price to be agreed. Production delay 4/5 weeks)

**ON DEMAND MAY BE REALISED IN OTHER FINISHES OF THE COLOUR CHART. CONTACT OUR CUSTOMER SERVICE FOR MINIMUM QUANTITY, TIMING AND PRICE.**



**VARNISHED ALUMINIUM thermo packed** - bar length 2,7 M  
pack. 20 Pcs - 54 lm (white colour 40 Pcs - 108 lm)

Article	H mm
PJQTA 06-01	6
PJQTA 08-01	8
PJQTA 08-...	8
PJQTA 10-01	10
PJQTA 10-...	10
PJQTA 11-01	11
PJQTA 125-01	12,5

Available in the colours: 01. Available on demand 010 - 0106 - 02 - 03 - 11 - 17. The code of the selected colour must be added to the article code. E.g.: PJQTA 08... (chosen colour White) PJQTA 08-01.

## COLOURS

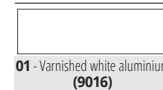

**01** - Varnished white aluminium (9016)

**For other colors than white in sizes 06, 11, 125, contact the sales office for quantities and prices**

## ON DEMAND MINIMUM QUANTITY 100 PCS

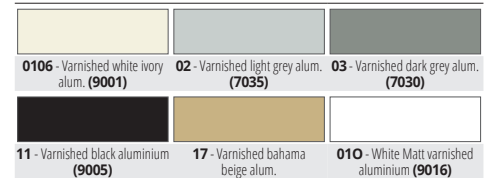

(Price to be agreed. Production delay 4/5 weeks)

# CAPSULES, END CAPS and THREE-WAYS JOINTS

\* Capsules & end caps of the on demand profiles are also on demand

POLISHED BRUSHED, VARNISHED ALUMINIUM/ PLASTIC

## CAPSULES & CAPS - POLISHED BRUSHED ALUMINIUM

Article	H mm	Pack 10 Pcs	Pack 2 Pcs
CPJQTBS .../...	08/10/11/125		
IPJQTBS .../...	08/10/11/125		
TPJQTBS .../...	08/10/11/125		
CPJQTBS .../...	08/10/11/125		
IPJQTBS .../...	08/10/11/125		
TPJQTBS .../...	08/10/11/125		
CPJQTBAS .../...	10/125		
IPJQTBAS .../...	10/125		
TPJQTBAS .../...	10/125		

Choose the desired pack. & height  
Ex.: 4,5 mm capsule in 10 Pcs Pack - CPJQTBS 10/10

## CAPSULES & CAP - VARNISHED ALUMINIUM

Article	H mm	Pack 10 Pcs	Pack 2 Pcs
CPJQTA .../...	06/08/10/11/125		
IPJQTA .../...	06/08/10/11/125		
TPJQTA .../...	06/08/10/11/125		

Choose the desired pack. & height  
Ex.: 4,5 mm capsule in 10 Pcs Pack - CPJQTA 02-10/10

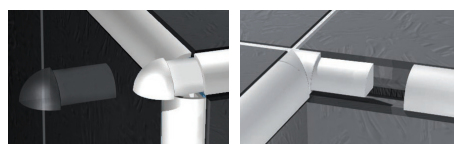

## JOINTS - PLASTIC

Article	H mm	Pack 10 Pcs	Pack 2 Pcs
GIJQT .../...	06/08/10/11/125		

Choose the desired pack. & height  
Ex.: 10 mm joint in 10 Pcs Pack - GIJQT 10/10

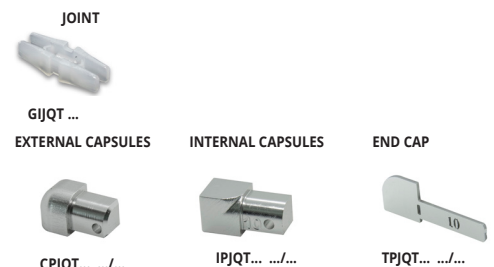





**PROJOLLY QUART** is a quarter-circle rounded bead profile in powder coated aluminum that can be applied on external corners of coverings. It can be used to close the perimeter of coverings. Its particular section and the availability of thirteen finishes and special pieces such as internal and external corners, junctions and end caps make **PROJOLLY QUART** an elegant and much-sought after profile.

# PROJOLLY QUART

STONE LINE ALUMINIUM



**STONE LINE ALUMINIUM thermo packed**  
bar length **2,7 M** - pack. **20 Pcs - 54 lm**

Article	H mm		
PJQTA 06-SL...	6		
PJQTA 08-SL...	8		
PJQTA 10-SL...	10		
PJQTA 11-SL...	11		
PJQTA 125-SL...	12,5		

Available in the colours: SL01 - SL02 - SL03 - SL04 - SL05 - SL06 - SL07 - SL08 - SL09 - SL10 - SL11 - SL12 - SL13.  
The code of the selected colour must be added to the article code.  
E.g.: PJQTA 08... (chosen colour stone white) PJQTA 08-SL01.

## COLOURS

STONE LINE						
SL01 - Stone white	SL02 - Stone cream	SL03 - Stone greyvory	SL04 - Stone sand	SL05 - Stone gray	SL06 - Stone cristal gray	SL07 - Stone antragrays
SL08 - Stone antradark	SL09 - Stone bronze	SL10 - Stone corten	SL11 - Stone brown	SL12 - Stone black	SL13 - Stone oyster grey	

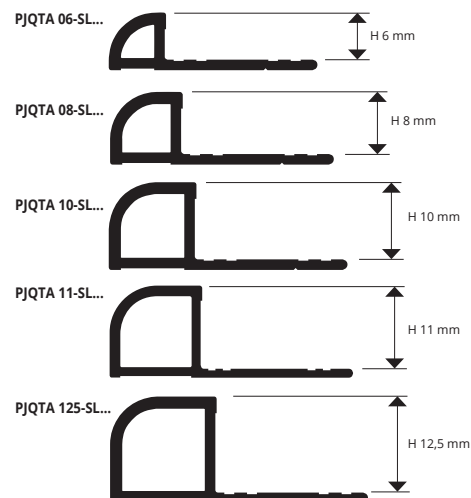

## EXAMPLES AND INSTRUCTIONS FOR LAYING METHODS

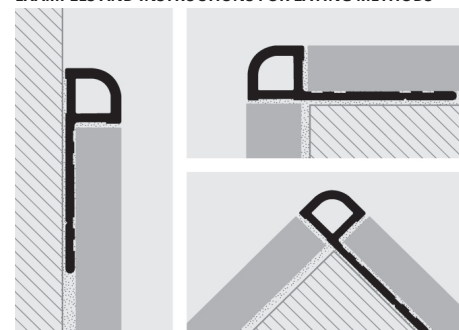

1. Choose "PROJOLLY QUART" according to the tile thickness and desired finish.
2. Cut "PROJOLLY QUART" to the desired length and apply the adhesive on the support where the profile will be laid.
3. Press the anchoring flange of "PROJOLLY QUART" into the adhesive.
4. Lay the tiles, aligning them with the profile leaving a 2 mm joint.
5. Remove immediately all remains of adhesive from the surface of the profile.
6. Fill the joints between the profile and the tiles with grout, in order to avoid water stagnation. Remove immediately all the remains of grout from the surface of the profile.

## CAPSULES, END CAPS and THREE-WAYS JOINTS

STONE LINE ALUMINIUM / PLASTIC

Capsules & end caps of the on demand profiles are also on demand \*

### JOINTS - PLASTIC

Article	H mm	Pack 10 Pcs	Pack 2 Pcs
GIJQT .../...	06/08/10/ 11/125		

Choose the desired pack. & height  
Ex.: 10 mm joint in 10 Pcs Pack - GIJQT 10/10

END CAP  
GIJQT .../...



### CAPSULES & CAP - STONE LINE ALUMINIUM

Article	H mm	Pack 10 Pcs	Pack 2 Pcs
CPJQTA ...-SL.../...	06/08/10/ 11/125		
IPJQTA ...-SL.../...	06/08/10/ 11/125		
TPJQTA ...-SL.../...	06/08/10/ 11/125		

Choose the desired pack. & height  
Ex.: 4,5 mm capsule in 10 Pcs Pack - CPJQTA 10-SL06/10

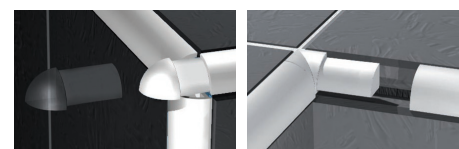

EXTERNAL CAPSULES

INTERNAL CAPSULES



CPJQTA .../...



IPJQTA .../...



JOINT  
TPJQT.../...

\* = Production on demand with minimum quantity of 80 pcs. Production delay 4/5 weeks. Price to be agreed

# PROJOLLY QUART

SHOCKPROOF NON - TOXIC COLORED VINYL RESIN

**PROJOLLY QUART** is a quarter-circle rounded bead profile in shockproof non - toxic colored vinyl resin that can be applied on external corners of coverings. It can be used to close the perimeter of coverings. Its particular section, the availability in different colours also on demand and special pieces such as internal and external corners make **PROJOLLY QUART** a much sought-after profile. It can be easily matched with the wall covering and allows an elegant workmanlike application.

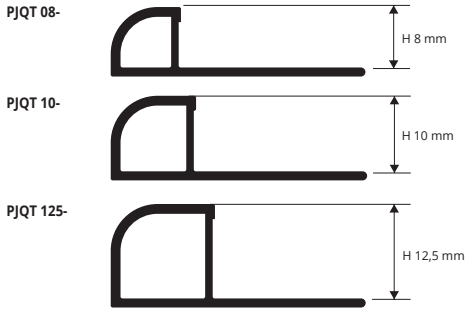

## EXAMPLES AND INSTRUCTIONS FOR LAYING METHODS

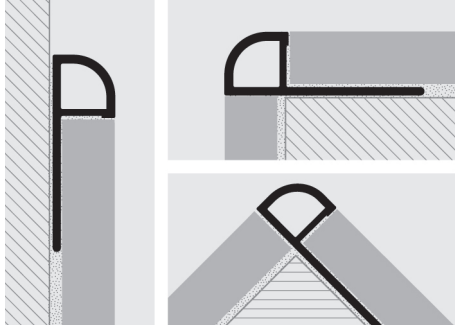

1. Choose "PROJOLLY QUART" according to the tile thickness and desired colour.
2. Cut "PROJOLLY QUART" to the desired length and apply the adhesive on the support where the profile will be laid.
3. Press the anchoring flange of "PROJOLLY QUART" into the adhesive.
4. Lay the tiles, aligning them with the profile leaving a 2 mm joint.
5. Fill the joints between the profile and the tiles with grout, in order to avoid water stagnation.

**NON-TOXIC SHOCKPROOF VINYL RESIN**  
bar length **2,7 lm** - pack. **54 lm** (white colour pack. **108 lm**)

Article	H mm		
PJQT 08-...	8		
PJQT 10-...	10		
PJQT 125-...	12,5		

Available in the colours: 00-01-02-03-05-06-11-17-18.  
Available on demand 0106 - 04 - 07 - 08 - 09 - 10-12-13-14-15-16-19-20-21-22-23-24-25-26-27-28-29 with a minimum quantity order of 800 pcs. The code of the selected colour must be added to the article code. E.g.: PJQT 08-... (chosen colour white) PJQT 08-01.

**WHITE NOT FOR SALE SINGLY**

## COLOURS

00 - White ice	01 - White	02 - Light grey	03 - Cement gray	05 - Dark beige	06 - Ivory
11 - Black	17 - Bahama beige	18 - Grey			

**ON DEMAND - MINIMUM QUANTITY 800 PCS** by colour and height (Price to be agreed, Production delay 4/5 weeks)

0106 - White ivory	04 - Light beige	07 - Pink	08 - Sky blue	09 - Yellow	10 - Red
12 - Silver	13 - Gold	14 - Green	15 - Brown	16 - Blue	19 - Beige
20 - Dark ivory	21 - Light pink	22 - Dark pink	23 - Dark antique pink	24 - Dark sky blue	25 - Brick red
26 - Turquoise green	27 - Dark green	28 - Hazel brown	29 - Dark brown		

## CAPSULES and THREE-WAYS JOINTS

POLYPROPYLENE/POLYETYLENE UV RESISTANT

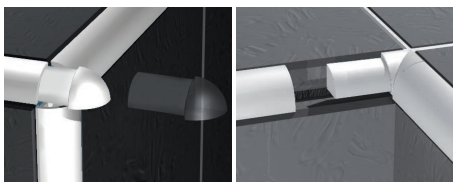

### POLYPROPYLENE/POLYETYLENE UV RESISTANT

Article	H mm	Pack. 20 Pcs	Pack. 5 Pcs
CPJQT 08-.../...	8		
IPJQT 08-.../...	8		
CPJQT 10-.../...	10		
IPJQT 10-.../...	10		
CPJQT 125-.../...	12,5		
IPJQT 125-.../...	12,5		

Available in the colours: 01-02-03-05-06-11-17-18 (available on demand 0106-04-07-08-09-10-12-13-14-15-16-19-20-21-22-23-24-25-26-27-28-29). The code of the selected colour must be added to the article code. E.g.: CPJQT 08-.../... (chosen colour white) CPJQT 08-01/20.

### EXTERNAL CAPSULES



CPJQT ...-.../...

### INTERNAL CAPSULES



IPJQT ...-.../...





# PROJOLLY

**PROJOLLY** is a rounded bead profile in polished, super polished, sanded and brushed stainless steel AISI 304/1.4301-V2A that can be applied on external corners of coverings. It can be used to close the perimeter of coverings and like a connection profile between step tread and riser of stairs coated with ceramic or natural stone tiles. Its particular section, the availability in three different finishes and special pieces such as internal and external corners, end caps and joints make **PROJOLLY** a much sought-after profile that allows a workmanlike application even in environments subject to high mechanical stresses.

POLISHED, SUPER POLISHED, SANDED AND BRUSHED STAINLESS STEEL AISI 304/1.4301-V2A



**POLISHED STAINLESS STEEL AISI 304/1.4301-V2A with protective film**  
bar length 2,7 lm - pack. 20 Pcs - 54 lm - 10/10 mm

**BRUSHED STAINLESS ST. AISI 304/1.4301-V2A with protective film**  
bar length 2,7 lm - pack. 20 Pcs - 54 lm - 10/10 mm

Article	H mm		
PJAC 06	6		
PJAC 08	8		
PJAC 10	10		
PJAC 11	11		
PJAC 125	12,5		
PJAC 15	15		

Article	H mm		
PJACS 06	6		
PJACS 08	8		
PJACS 10	10		
PJACS 11	11		
PJACS 125	12,5		
PJACS 15	15		

**SUPER POLISHED STAINLESS ST. AISI 304/1.4301-V2A**  
thermo packed - bar length 2,7 lm - pack. 20 Pcs  
54 lm - 10/10 mm



Article	H mm		
PJACML 06	6		
PJACML 08	8		
PJACML 10	10		
PJACML 11	11		
PJACML 125	12,5		
PJACML 15	15		

**SANDED STAINLESS INOX AISI 304/1.4301-V2A with protective film**  
bar length 2,7 ml - pack. 20 Pcs 54 lm - 10/10 mm

Article	H mm		
PJACSB 08	8		
PJACSB 10	10		
PJACSB 125	12,5		

### COLOURS

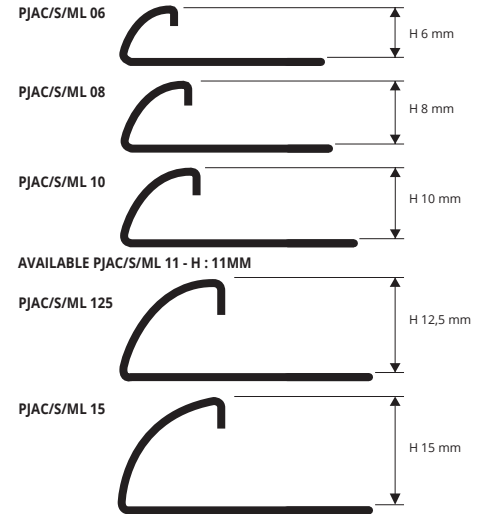

### EXAMPLES AND INSTRUCTIONS FOR LAYING METHODS

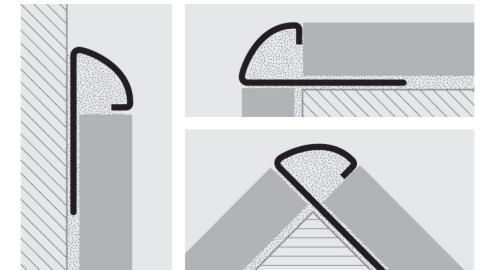

1. Choose "PROJOLLY" according to the tile thickness and desired finish.
2. Cut "PROJOLLY" to the desired length and apply the adhesive on the support where the profile will be laid.
3. Press the anchoring flange of "PROJOLLY" into the adhesive.
4. Lay the tiles, aligning them with the profile leaving a 2 mm joint. Remove immediately all remains of adhesive from the surface of the profile.
5. Fill the joints between the profile and the tiles with grout, in order to avoid water stagnation. Remove immediately all the remains of grout from the surface of the profile.

SUITABLE FOR USE IN CONTACT WITH FOODSTUFFS.

## CAPSULES, END CAPS and THREE-WAYS JOINTS

POLISHED, SUPER POLISHED AND BRUSHED STAINLESS ST. AISI 304/1.4301-V2A / PLASTIC

Capsules & end caps of the on demand profiles are also on demand \*

**CAPSULES and END CAPS - POLISHED STAINLESS ST. AISI 304/1.4301-V2A**

Article	H mm	Pack 10 Pcs	Pack 2 Pcs
CPJAC 06/...	6		
IPJAC 06/...	6		
CPJAC 08/...	8		
IPJAC 08/...	8		
CPJAC 10/...	10		
IPJAC 10/...	10		
CPJAC 11/...	11		
IPJAC 11/...	11		
CPJAC 125/...	12,5		
IPJAC 125/...	12,5		
CPJAC 15/...	15		
IPJAC 15/...	15		
TPJAC 06-08-10-11-125-15-.../...			

Choose the desired packaging: E.g.: CPJAC .../10 (Pack 10 Pcs)  
CPJAC .../2 (Pack 2 Pcs)

**CAPSULES and END CAPS - BRUSHED STAINLESS ST. AISI 304/1.4301-V2A**

Article	H mm	Pack 10 Pcs	Pack 2 Pcs
CPJACS 06/...	6		
IPJACS 06/...	6		
CPJACS 08/...	8		
IPJACS 08/...	8		
CPJACS 10/...	10		
IPJACS 10/...	10		
CPJACS 11/...	11		
IPJACS 11/...	11		
CPJACS 125/...	12,5		
IPJACS 125/...	12,5		
CPJACS 15/...	15		
IPJACS 15/...	15		
TPJACS 06-08-10-11-125-15-.../...			

Choose the desired packaging: E.g.: CPJACS .../10 (Pack 10 Pcs)  
CPJACS .../2 (Pack 2 Pcs)

**CAPSULES - SUPER POLISHED STAINLESS ST. AISI 304/1.4301-V2A**

Article	H mm	Pack 10 Pcs	Pack 2 Pcs
CPJACML 06/...	6		
IPJACML 06/...	6		
CPJACML 08/...	8		
IPJACML 08/...	8		
CPJACML 10/...	10		
IPJACML 10/...	10		
CPJACML 11/...	11		
IPJACML 11/...	11		
CPJACML 125/...	12,5		
IPJACML 125/...	12,5		
CPJACML 15/...	15		
IPJACML 15/...	15		

Choose the desired packaging: E.g.: CPJACML .../10 (Pack 10 Pcs)  
CPJACML .../2 (Pack 2 Pcs)

### JOINTS - PLASTIC

Article	H mm	Pack 10 Pcs	Pack 2 Pcs
GIJAC 06/...	6		
GIJAC 08/...	8		
GIJAC 10/...	10		
GIJAC 11/...	11		
GIJAC 125/...	12,5		
GIJAC 15/...	15		

Choose the desired packaging: E.g.: GIJAC .../10 (Pack 10 Pcs)  
GIJAC .../2 (Pack 2 Pcs)

**CAPSULES - SANDED STAINLESS INOX AISI 304/1.4301-V2A**

Article	H mm	Pack 10 Pcs	Pack 2 Pcs
CPJACSB 08/...	8		
IPJACSB 08/...	8		
CPJACSB 10/...	10		
IPJACSB 10/...	10		
CPJACSB 125/...	12,5		
IPJACSB 125/...	12,5		

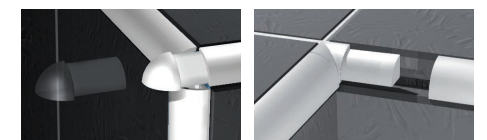

\* = Production on demand with minimum quantity of 100 pcs. Production delay 4/5 weeks. Price to be agreed

# PROJOLLY

POLISHED STAINLESS STEEL INOX AISI 316LL/1.4404-V4A

**PROJOLLY** is a rounded bead profile in polished stainless steel INOX AISI 316LL/1.4404-V4A that can be applied on external corners of coverings. It can be used to close the perimeter of coverings and like a connection profile between step tread and riser of stairs coated with ceramic or natural stone tiles. Its particular section, the availability in three different finishes and special pieces such as internal and external corners, end caps and joints make **PROJOLLY** a much sought-after profile that allows a workmanlike application even in environments subject to high mechanical and chemical stresses.

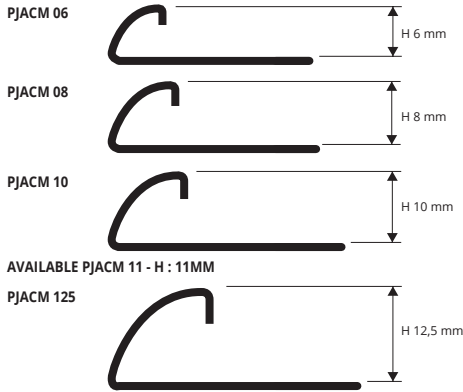

### EXAMPLES OF LAYING

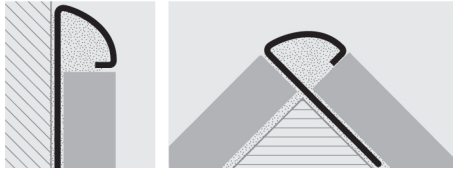

POLISHED STAINLESS STEEL AISI 316LL/1.4404-V4A  
with protective film  
- bar length 2,7 lm - pack 20 Pcs - 54 lm - 10/10 mm



Article	H mm		
PJACM 06	6		
PJACM 08	8		
PJACM 10	10		
PJACM 11	11		
PJACM 125	12,5		

SUITABLE FOR USE IN CONTACT WITH FOODSTUFFS.



### COLOURS



1. Choose "PROJOLLY" according to the tile thickness. 2. Cut "PROJOLLY" to the desired length and apply the adhesive on the support where the profile will be laid. 3. Press the anchoring flange of "PROJOLLY" into the adhesive. 4. Lay the tiles, aligning them with the profile leaving a 2 mm joint. Remove immediately all remains of adhesive from the surface of the profile. 5. Fill the joints between the profile and the tiles with grout, in order to avoid water stagnation. Remove immediately all the remains of grout from the surface of the profile.

# CAPSULES and THREE-WAYS JOINTS

POLISHED STAINLESS STEEL AISI 316LL/1.4404-V4A

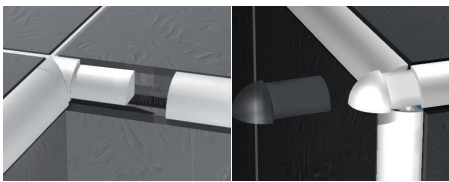

POLISHED STAINLESS STEEL AISI 316LL/1.4404-V4A

Article	H mm	Pack 10 Pcs	Pack 2 Pcs
CPJACM 06/...	6		
IPJACM 06/...	6		
CPJACM 08/...	8		
IPJACM 08/...	8		
CPJACM 10/...	10		
IPJACM 10/...	10		
CPJACM 11/...	11		
IPJACM 11/...	11		
CPJACM 125/...	12,5		
IPJACM 125/...	12,5		

Choose the desired packaging: E.g.: CPJACM .../10 (Pack. 10 Pcs)  
CPJACM .../2 (Pack. 2 Pcs)

### EXTERNAL CAPSULES



### INTERNAL CAPSULES



# PROTERMINAL

POLISHED STAINLESS STEEL INOX AISI 316LL/1.4404-V4A

**PROTERMINAL** is a "L-shaped" profile in polished stainless steel INOX AISI 316LL/1.4404-V4A that can be applied on external corners of coverings. It can be used to close the perimeter of coverings, like a connection profile between step tread and riser of stairs coated with ceramic or natural stone tiles, and also as separation profile for floor coverings. Its particular section and the availability in three different heights make **PROTERMINAL** a much sought-after profile that allows a workmanlike application even in environments subject to high mechanical and chemical stresses.

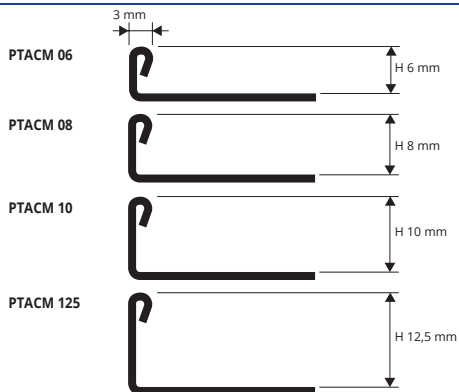

### EXAMPLES OF LAYING

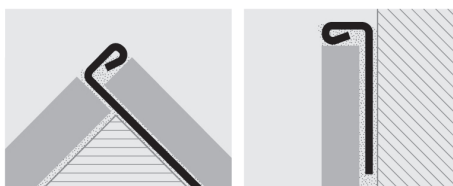

### COLOURS



1. Choose "PROTERMINAL" according to the tile thickness. 2. Cut "PROTERMINAL" to the desired length and apply the adhesive on the support where the profile will be laid. 3. Press the anchoring flange of "PROTERMINAL" into the adhesive. 4. Lay the tiles, aligning them with the profile leaving a 2 mm joint. Remove immediately all remains of adhesive from the surface of the profile. 5. Fill the joints between the profile and the tiles with grout, in order to avoid water stagnation. Remove immediately all the remains of grout from the surface of the profile.



POLISHED STAINLESS STEEL AISI 316LL/1.4404-V4A  
bar length 2,7 lm - pack 40 Pcs - 108 lm - 10/10 mm



Article	H mm		
PTACM 06	6		
PTACM 08	8		
PTACM 10	10		
PTACM 125	12,5		

SUITABLE FOR USE IN CONTACT WITH FOODSTUFFS.



# PROJOLLY

**PROJOLLY** is a rounded bead profile in natural, antique brass, polished varnished and chromed brass that can be applied on external corners of coverings. It can be used to close the perimeter of coverings and like (only natural and chromed version) a connection profile between step tread and riser of stairs coated with ceramic or natural stone tiles. Its particular section, the availability in three different finishes and special pieces such as internal and external corners, end caps and joints make **PROJOLLY** a much sought-after and elegant profile that allows a workmanlike application.

NATURAL, POLISHED VARNISHED, CHROMED AND ANTIQUE BRASS

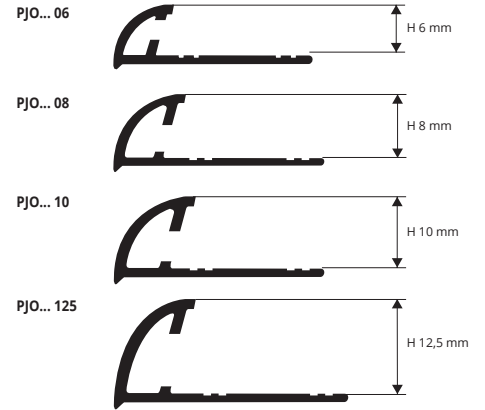

**NATURAL BRASS thermo packed**  
bar length 2,7 lm - pack. 20 Pcs - 54 lm

Article	H mm
PJON 08	8
PJON 10	10
PJON 125	12,5

**SUPER POLISHED VARNISHED CHROMED BRASS**  
thermo packed bar length 2,7 lm - pack. 20 Pcs - 54 lm



Article	H mm
PJOC 06	6
PJOC 08	8
PJOC 10	10
PJOC 125	12,5

### COLOURS



**POLISHED VARNISHED BRASS thermo packed**  
bar length 2,7 lm - pack. 20 Pcs - 54 lm

Article	H mm
PJOL 06	6
PJOL 08	8
PJOL 10	10
PJOL 125	12,5

Polished varnished brass is not suitable for frequent pedestrian traffic places and/or scratching.

**ANTIQUÉ BRASS thermo packed**  
bar length 2,7 lm - pack. 20 Pcs - 54 lm

Article	H mm
PJOB 08	8
PJOB 10	10
PJOB 125	12,5

### EXAMPLES AND INSTRUCTIONS FOR LAYING METHODS

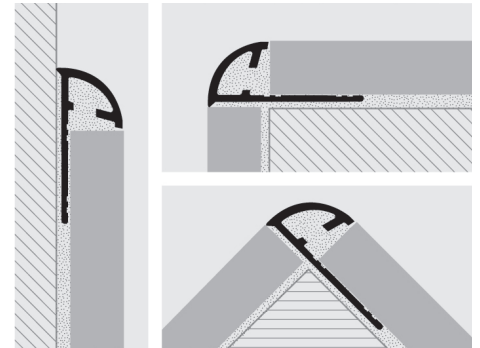

1. Choose "PROJOLLY" according to the tile thickness and desired finish.
2. Cut "PROJOLLY" to the desired length and apply the adhesive on the support where the profile will be laid.
3. Press the anchoring flange of "PROJOLLY" into the adhesive.
4. Lay the tiles, aligning them with the profile leaving a 2 mm joint. Remove immediately all remains of adhesive from the surface of the profile.
5. Fill the joints between the profile and the tiles with grout, in order to avoid water stagnation. Remove immediately all the remains of grout from the surface of the profile.

## CAPSULES, END CAPS and THREE-WAYS JOINTS

VARNISHED POLISHED BRASS AND CHROMED BRASS EFFECT / PLASTIC

Capsules & end caps of the on demand profiles are also on demand \*

### CAPS and JOINTS - CHROMED BRASS / PLASTIC

Article	H mm	Pack 10 Pcs	Pack 2 Pcs
TPJOC 06-08-10-125/...	6-8-10-12,5		
GJJA 06-08-10-125/...	6-8-10-12,5		

Choose the desired packaging: E.g.: GJJA.../10 (Pack. 10 Pcs)  
GJJA.../2 (Pack. 2 Pcs)

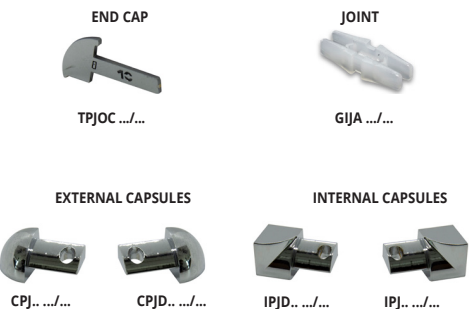

### LEFT CAPSULES - POLISHED VARNISHED/CHROMED BRASS

Article	H mm	Pack 10 Pcs	Pack 2 Pcs
CPJOL/OC 06/...	6		
IPJOL/OC 06/...	6		
CPJOL/OC 08/...	8		
IPJOL/OC 08/...	8		
CPJOL/OC 10/...	10		
IPJOL/OC 10/...	10		
CPJOL/OL 125/...	12,5		
IPJOL/OC 125/...	12,5		

Choose the desired packaging: E.g.: CPJOL.../10 (Pack. 10 Pcs)  
CPJOL.../2 (Pack. 2 Pcs)

The right capsules are available on demand and must be used only in the following cases:  
A) when you are laying the cut base of the profile perpendicularly on the floor;

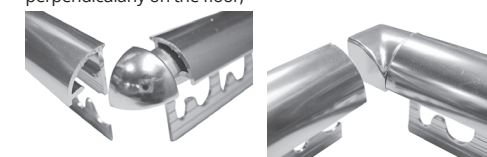

Add "D" to the article code. For example: CPJDOL 06.

Add "D" to the article code. For example: IPJDOL 06.

### LEFT CAPSULES - ANTIQUÉ BRASS

Article	H mm	Pack 10 Pcs	Pack 2 Pcs
CPJOB 08/...	8		
IPJOB 08/...	8		
CPJOB 10/...	10		
IPJOB 10/...	10		
CPJOB 125/...	12,5		
IPJOB 125/...	12,5		

Choose the desired packaging: E.g.: CPJOB.../10 (Pack. 10 Pcs)  
CPJOB.../2 (Pack. 2 Pcs)



LEFT CAPSULES  
Add "D" to the article code. For example: CPJDOL 06.

RIGHT CAPSULES

# PROJOLLY

ANODIZED ALUMINIUM  
SILVER, COPPER, TITANIUM, GOLD AND BLACK

**PROJOLLY** is a rounded bead profile in anodized aluminium that can be applied on external corners of coverings. It can be used to close the perimeter of coverings and like a connection profile between step tread and riser of stairs coated with ceramic or natural stone tiles. Its particular section and elegance, the availability in five different finishes and special pieces such as internal and external corners, end caps and joints make **PROJOLLY** a much sought-after and elegant profile that allows a workmanlike application.

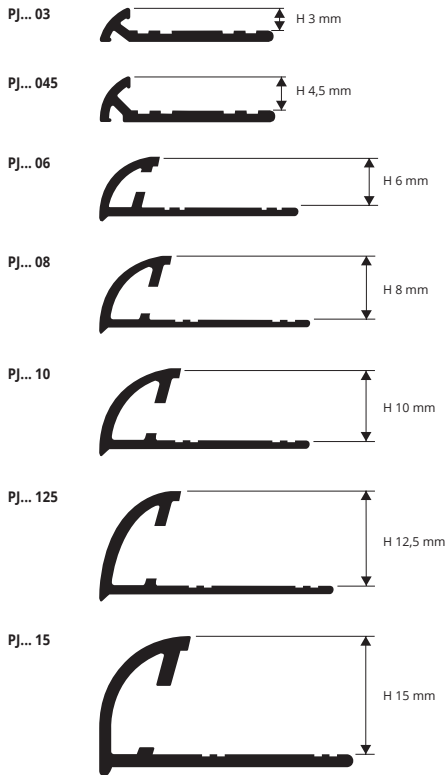

### EXAMPLES AND INSTRUCTIONS FOR LAYING METHODS

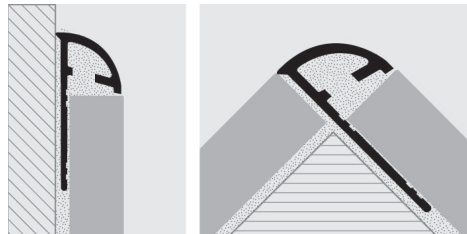

1. Choose "PROJOLLY" according to the tile thickness and desired finish.
2. Cut "PROJOLLY" to the desired length and apply the adhesive on the support where the profile will be laid.
3. Press the anchoring flange of "PROJOLLY" into the adhesive.
4. Lay the tiles, aligning them with the profile leaving a 2 mm joint. Remove immediately all remains of adhesive from the surface of the profile.
5. Fill the joints between the profile and the tiles with grout, in order to avoid water stagnation. Remove immediately all the remains of grout from the surface of the profile.

**ANODIZED ALUM.** (silver-copper-gold-titanium-black) thermo packed bar length 2,7 lm - pack. 40 Pcs - 108 lm  
(for H 15 anodized silver alum. pack. 20 Pcs - 54 lm)

Article	H mm		
PJAA 03	3		
PJAA 045	4,5		
PJAA 06	6		
PJAA 08	8		
PJAA 10	10		
PJAA 125	12,5		
PJAA 15	15		
PJAO 03	3		
PJAO 045	4,5		
PJAO 06	6		
PJAO 08	8		
PJAO 10	10		
PJAO 15	15		
PJAR 08	8		
PJAR 10	10		
PJAR 125	12,5		
PJAT 08	8		
PJAT 10	10		
PJAT 125	12,5		
PJNE 08	8		
PJNE 10	10		
PJNE 125	12,5		

### COLOURS



## CAPSULES, END CAPS and THREE-WAYS JOINTS

\* Capsules & end caps of the on demand profiles are also on demand

Anodized ALUMINIUM (silver, copper, titanium, gold and black) / PLASTIC

### LEFT CAPSULES ANODIZED ALUMINIUM

(silver, copper, titanium and gold)

Article	H mm	Pack 10 Pcs	Pack 2 Pcs
CPJAA .../...	06/08/10/125		
CPJAA 15/...	15		
IPJAA .../...	06/08/10/125		
IPJAA 15/...	15		
TPJAA .../...	06/08/10/125/15		
CPJAO .../...	06/08/10		
CPJAO 15/...	15		
IPJAO .../...	06/08/10		
IPJAO 15/...	15		
TPJAO .../...	06/08/10/15		
CPJAR .../...	08/10/125		
IPJAR .../...	08/10/125		
TPJAR .../...	08/10/125		
CPJAT .../...	08/10/125		
IPJAT .../...	08/10/125		
TPJAT .../...	08/10/125		
CPJNE .../...	08/10/125		
IPJNE .../...	08/10/125		
TPJNE .../...	08/10/125		

Choose the desired pack. & height  
Ex.: 4,5 mm capsule in 10 Pcs Pack - CPJAA 10/10

### JOINTS - PLASTIC

Article	H mm	Pack 10 Pcs	Pack 2 Pcs
GIIJA .../...	06/08/10/125/15		

Choose the desired pack. & height  
Ex.: 10 mm joint in 10 Pcs Pack - GIIJA 10/10

#### EXTERNAL CAPSULES



#### INTERNAL CAPSULES



#### CAPS



TPJ.../...

#### JOINTS



GIIJA .../...

The right capsules are available on demand and must be used only in the following cases:

A) when you are laying the cut base of the profile perpendicularly on the floor;

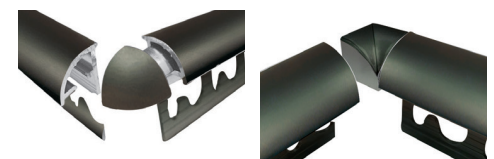

Add "D" to the article code. For example: CPJDAA 06.

Add "D" to the article code. For example: IPJDAA 06.

B) as an alternative to end-caps (right side).



LEFT CAPSULES

RIGHT CAPSULES

Add "D" to the article code. For example: CPJDAA 06.

\* = Production on demand with minimum quantity of 100 pcs. Production delay 4/5 weeks. Price to be agreed

**PROJOLLY** is a rounded bead profile in polished aluminium that can be applied on external corners of coverings. It can be used to close the perimeter of coverings and like a connection profile between step tread and riser of stairs coated with ceramic or natural stone tiles. Its particular section and elegance, the availability in five different finishes and special pieces such as internal and external corners, end caps and joints make **PROJOLLY** a much sought-after and elegant profile that allows a workmanlike application.

# PROJOLLY

POLISHED ALUMINIUM  
CHROME, COPPER, TITANIUM, GOLD AND BLACK



POLISHED ALUMINIUM (chrome-copper-titanium-gold-black)  
thermo packed - bar length 2,7 lm - pack. 40 Pcs - 108 lm (H 15 mm - 54 lm)

Article	H mm		
PJBC 03	3		
PJBC 045	4,5		
PJBC 06	6		
PJBC 08	8		
PJBC 10	10		
PJBC 125	12,5		
PJBC 15	15		
PJBO 03	3		
PJBO 045	4,5		
PJBO 06	6		
PJBO 08	8		
PJBO 10	10		
PJBO 125	12,5		
PJBR 08	8		
PJBR 10	10		
PJBR 125	12,5		
PJBT 08	8		
PJBT 10	10		
PJBT 125	12,5		
PJBN 08	8		
PJBN 10	10		
PJBN 125	12,5		

### EXAMPLES AND INSTRUCTIONS FOR LAYING METHODS

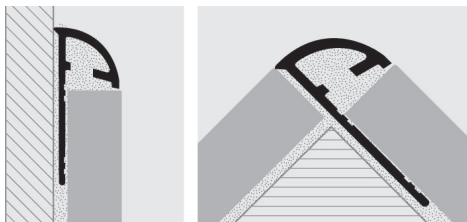

1. Choose "PROJOLLY" according to the tile thickness and desired finish.
2. Cut "PROJOLLY" to the desired length and apply the adhesive on the support where the profile will be laid.
3. Press the anchoring flange of "PROJOLLY" into the adhesive.
4. Lay the tiles, aligning them with the profile leaving a 2 mm joint.
5. Remove immediately all remains of adhesive from the surface of the profile.
5. Fill the joints between the profile and the tiles with grout, in order to avoid water stagnation.
5. Remove immediately all the remains of grout from the surface of the profile.

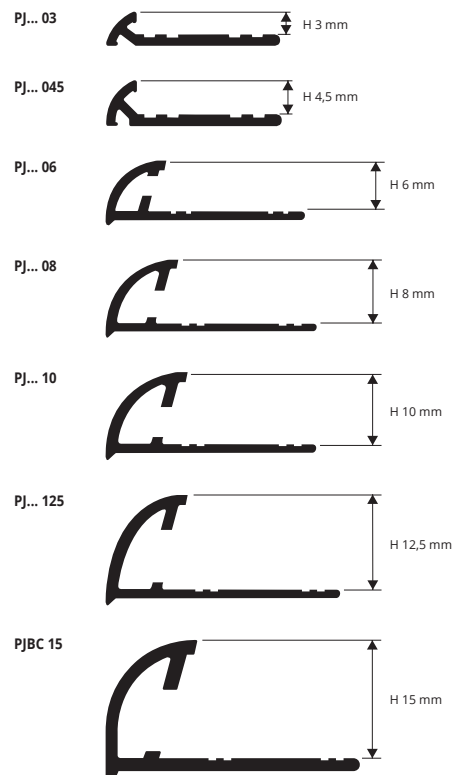

### COLOURS



## CAPSULES, END CAPS and THREE-WAYS JOINTS

POLISHED ALUMINIUM (chrome, copper, titanium, gold, black) / PLASTIC

Capsules & end caps of the on demand profiles are also on demand \*

### JOINTS - PLASTIC

Article	H mm	Pack 10 Pcs	Pack 2 Pcs
GIJA .../...	06/08/10/125/15		

Choose the desired pack. & height  
Ex.: 10 mm joint in 10 Pcs Pack - GIJA 10/10

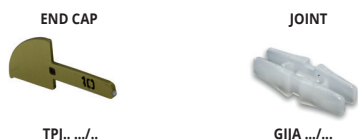

### EXTERNAL CAPSULES



### INTERNAL CAPSULES



### LEFT CAPSULES POLISHED ALUMINIUM chrome, copper, titanium and gold

Article	H mm	Pack 10 Pcs	Pack 2 Pcs
CPJBC .../...	06/08/10/125		
CPJBC 15/...	15		
IPJBC .../...	06/08/10/125		
IPJBC 15/...	15		
TPJBC .../...	06/08/10/125/15		
CPJBO .../...	06/08/10/125		
IPJBO .../...	06/08/10/125		
TPJBO .../...	06/08/10/15		
CPJBR .../...	08/10/125		
IPJBR .../...	08/10/125		
TPJBR .../...	08/10/125		
CPJBT .../...	08/10/125		
IPJBT .../...	08/10/125		
TPJBT .../...	08/10/125		
CPJBN .../...	08/10/125		
IPJBN .../...	08/10/125		
TPJBN .../...	08/10/125		

Choose the desired pack. & height  
Ex.: 4,5 mm capsule in 10 Pcs Pack - CPJBC 10/10

(\* ) 12,5/15 mm NOT SUITABLE FOR THREE-WAYS CORNER

The right capsules are available on demand and must be used only in the following cases:

A) when you are laying the cut base of the profile perpendicularly on the floor;

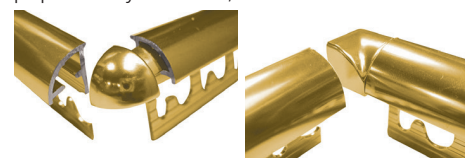

Add "D" to the article code. For example: CPJDBC 06. Add "D" to the article code. For example: IPJDBC 06.

B) as an alternative to end-caps (right side).



LEFT CAPSULES Add "D" to the article code. For example: CPJDBC 06. RIGHT CAPSULES Add "D" to the article code. For example: CPJDBC 06.

# PROJOLLY

BRUSHED ALUMINIUM

**PROJOLLY** is a rounded bead profile in brushed aluminium that can be applied on external corners of coverings. It can be used to close the perimeter of coverings and like a connection profile between step tread and riser of stairs coated with ceramic or natural stone tiles. Its particular section and elegance, the availability in four different finishes and special pieces such as internal and external corners, end caps and joints make **PROJOLLY** a much sought-after and elegant profile that allows a workmanlike application.

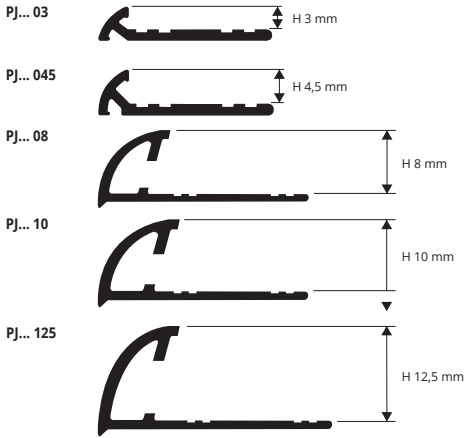

**BRUSHED POLISHED ALUMINIUM** (silver-gold-copper-titanium-black)  
thermo packed - bar length 2,7 lm - pack. 40 Pcs - 108 lm

Article	H mm		
PJBS 03	3		
PJBS 045	4,5		
PJBS 08	8		
PJBS 10	10		
PJBS 125	12,5		
PJRS 03	3		
PJRS 045	4,5		
PJRS 08	8		
PJRS 10	10		
PJRS 125	12,5		
PJBOS 03	3		
PJBOS 045	4,5		
PJBOS 08	8		
PJBOS 10	10		
PJBOS 125	12,5		
PJTS 03	3		
PJTS 045	4,5		
PJTS 08	8		
PJTS 10	10		
PJTS 125	12,5		
PJNS 08	8		
PJNS 10	10		
PJNS 125	12,5		

## COLOURS



BS - Brushed polished silver alum. RS - Brushed polished copper alum. TS - Brushed polished titanium alum.



NS - Brushed polished black alum.

AVAILABLE MINIMUM QUANTITY 100 PCS by colour and height



BOS - Brushed gold alum.

(Price to be agreed. Production delay 4/5 weeks)

## EXAMPLES AND INSTRUCTIONS FOR LAYING METHODS

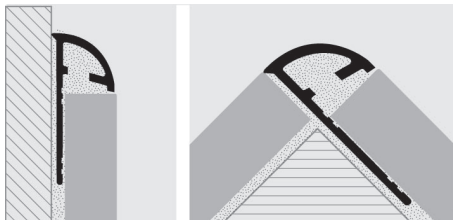

1. Choose "PROJOLLY" according to the tile thickness and desired finish. 2. Cut "PROJOLLY" to the desired length and apply the adhesive on the support where the profile will be laid. 3. Press the anchoring flange of "PROJOLLY" into the adhesive. 4. Lay the tiles, aligning them with the profile leaving a 2 mm joint. Remove immediately all remains of adhesive from the surface of the profile. 5. Fill the joints between the profile and the tiles with grout, in order to avoid water stagnation. Remove immediately all the remains of grout from the surface of the profile.

# CAPSULES, END CAPS and THREE-WAYS JOINTS

\* Capsules & end caps of the on demand profiles are also on demand

BRUSHED POLISHED ALUMINIUM (silver, copper, titanium, black) / PLASTIC

## LEFT CAPSULES - BRUSHED POLISHED ALUMINIUM

silver-gold-copper-titanium-black

Article	H mm	Pack 10 Pcs	Pack 2 Pcs
CPJBS .../...	08/10/125		
IPJBS .../...	08/10/125		
TPJBS .../...	08/10/125		
CPJBOS .../...	08/10/125		
IPJBOS .../...	08/10/125		
TPJBOS .../...	08/10/125		
CPJRS .../...	08/10/125		
IPJRS .../...	08/10/125		
TPJRS .../...	08/10/125		
CPJTS .../...	08/10/125		
IPJTS .../...	08/10/125		
TPJTS .../...	08/10/125		
CPJNS .../...	08/10/125		
IPJNS .../...	08/10/125		
TPJNS .../...	08/10/125		

Choose the desired pack. & height  
Ex: 4,5 mm capsule in 10 Pcs Pack - CPJBS 10/10

## JOINTS - PLASTIC

Article	H mm	Pack 10 Pcs	Pack 2 Pcs
GIJA .../...	08/10/125		

Choose the desired pack. & height  
Ex: 10 mm joint in 10 Pcs Pack - GIJA 10/10

### EXTERNAL CAPSULES



### INTERNAL CAPSULES



The right capsules are available on demand and must be used only in the following cases:  
A) when you are laying the cut base of the profile perpendicularly on the floor;

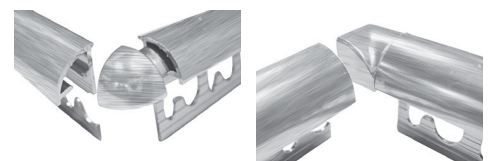

Add "D" to the article code. For example: CPJDBS 08.

B) as an alternative to end-caps (right side).



LEFT CAPSULES RIGHT CAPSULES  
Add "D" to the article code. For example: CPJDBS 08.

### END CAP



TPJ... /.../...

### JOINT



GIJA .../.../...

\* = Production on demand with minimum quantity of 100 pcs. Production delay 4/5 weeks. Price to be agreed



**PROJOLLY** is a rounded bead profile in varnished aluminium that can be applied on external corners of coverings. It can be used to close the perimeter of coverings. Its particular section and elegance, the availability in five different colours and special pieces such as internal and external corners, end caps and joints make **PROJOLLY** a much sought-after and elegant profile that allows a workmanlike application.

# PROJOLLY

VARNISHED ALUMINIUM



VARNISHED ALUMINIUM (HOT-WORKED 200°) thermo packed  
bar length 2,7 lm - pack. 20 Pcs-54 lm (colour white 40 Pcs - 108 lm)

Article	H mm
PJA 06-01	6
PJA 08-...	8
PJA 10-...	10
PJA 125-01	12,5

With H 8 and 10 mm available in the colours: 01 - 0106 - 0311 - 06 - 11  
Available on demand: 01O - 02-03-0211-10-17.  
The code of the selected colour must be added to the article code.  
E.g.: PJA 08... (chosen colour white) PJA 08-01.

## COLOURS

01 - Varnished white alum. (9016)	0106 - Varnished white ivory alum. (9001)	0311 - Varnished asphalt grey alum. (7043)
06 - Varnished ivory alum. (1015)	11 - Varnished black alum. (9005)	

AVAILABLE MINIMUM QUANTITY 100 PCS by colour and height  
(Price to be agreed, Production delay 4/5 weeks)

010 - Varnished white matt alum. (9016)	02 - Varnished light grey alum. (7035)	03 - Varnished stone grey alum. (7030)
0211 - Varnished quartz grey alum. (7039)	10 - Varnished klinker red alum. (8004)	17 - Varnished bahama beige alum.

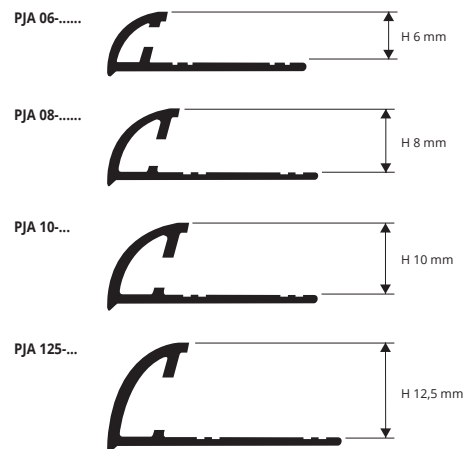

On demand may be realised in other finishes of the colour chart. Contact our customer service for minimal quantity, timing and price.

## EXAMPLES AND INSTRUCTIONS FOR LAYING METHODS

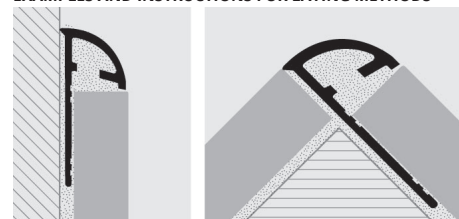

1. Choose "PROJOLLY" according to the tile thickness and desired colour.
2. Cut "PROJOLLY" to the desired length and apply the adhesive on the support where the profile will be laid.
3. Press the anchoring flange of "PROJOLLY" into the adhesive.
4. Lay the tiles, aligning them with the profile leaving a 2 mm joint. Remove immediately all remains of adhesive from the surface of the profile.
5. Fill the joints between the profile and the tiles with grout, in order to avoid water stagnation. Remove immediately all the remains of grout from the surface of the profile.

# CAPSULES, END CAPS and THREE-WAYS JOINTS

VARNISHED ALUMINIUM / PLASTIC

Capsules & end caps of the on demand profiles are also on demand

## LEFT CAPSULES VARNISHED ALUMINIUM (HOT-WORKED 200°)

Article	H mm	Pack 10 Pcs	Pack 2 Pcs
CPJA .../.../...	08/10/125		
IPJA .../.../...	08/10/125		
TPJA .../.../...	08/10/125		

Choose the desired pack. & height  
Ex.: 4,5 mm capsule in 10 Pcs Pack - CPJA 10-06/10 10/10

## EXTERNAL CAPSULES



## INTERNAL CAPSULES



## JOINTS - PLASTIC

Article	H mm	Pack 10 Pcs	Pack 2 Pcs
GIJA .../...	08/10/125		

Choose the desired pack. & height  
Ex.: 10 mm joint in 10 Pcs Pack - GIJA 10/10



The right capsules are available on demand and must be used only in the following cases:

A) when you are laying the cut base of the profile perpendicularly on the floor;

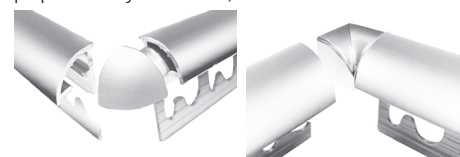

Add "D" to the article code. For example: CPJDA 06-01. Add "D" to the article code. For example: IPJDA 06-01.

B) as an alternative to end-caps (right side).

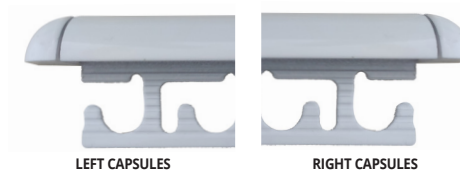

LEFT CAPSULES RIGHT CAPSULES  
Add "D" to the article code. For example: CPJDA 06-01.

# PROJOLLY

SHOCKPROOF NON - TOXIC  
COLORED VINYL RESIN

**PROJOLLY** is a rounded bead profile in shockproof non - toxic colored vinyl resin that can be applied on external corners of coverings. It can be used to close the perimeter of coverings. Its particular section, the availability in different colours also on demand and special pieces such as internal and external corners make **PROJOLLY** a much sought-after profile. It can be easily matched with the wall covering and allows an elegant workmanlike application.

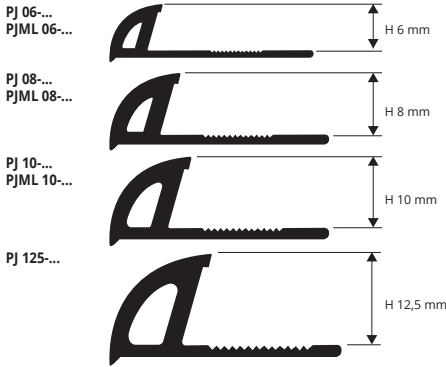

## EXAMPLES AND INSTRUCTIONS FOR LAYING METHODS

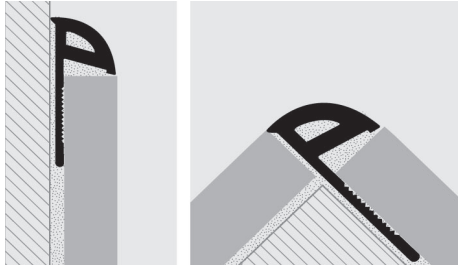

1. Choose "PROJOLLY" according to the tile thickness and desired colour. 2. Cut "PROJOLLY" to the desired length and apply the adhesive on the support where the profile will be laid. 3. Press the anchoring flange of "PROJOLLY" into the adhesive. 4. Lay the tiles, aligning them with the profile leaving a 2 mm joint. 5. Fill the joints between the profile and the tiles with grout, in order to avoid water stagnation.

## NON-TOXIC SHOCKPROOF VINYL RESIN

bar length 2,7 lm - pack. 54 lm (colour white pack. 108 lm)

Article	H mm		
PJ 06-...	6		
PJ 08-...	8		
PJ 10-...	10		
PJ 125-...	12,5		

Available in the colours: 00 - 01 - 02 - 03 - 04 - 05 - 06 - 07 - 08 - 09 - 11-12 - 13 - 14 - 15 - 17 - 18 - 0106.  
Available on demand 10 -16 -19 - 20 - 21 - 22 - 23 - 24 - 25 - 26 - 27 - 28 - 29 with a minimum quantity order of 800 pcs.  
The code of the selected colour must be added to the article code.  
E.g.: PJ 06... (chosen colour white) PJ 06-01.

WHITE NOT FOR SALE SINGLY

## NON-TOXIC SHOCKPROOF VINYL RESIN MIRROR LINE EXTRA POLISHED - bar length 2,7 lm pack. 54 lm (colour white pack. 108 lm)

Article	H mm		
PJML 06-00/01	6		
PJML 06-...	6		
PJML 08-00/01	8		
PJML 08-...	8		
PJML 10-00/01	10		
PJML 10-...	10		
PJML 125-00/01	12,5		
PJML 125-...	12,5		

available in the color: 01 - 00 (Available on demand 0106-02-03-04-05-07-08-09-10-11-14-15-16-17-0106-19-20-21-22-23-24-25-26-27-28-29 with a minimum quantity order of 800 pcs.)  
The code of the selected colour must be added to the article code.  
E.g.: PJ 06... (chosen colour white) PJ 06-01.  
Prices per metre are approximate. Articles not for sale singly.

WHITE NOT FOR SALE SINGLY

## COLOURS

00 - White ice	01 - White	0106 - White ivory	02 - Light grey	03 - Cement gray
04 - Light beige	05 - Dark beige	06 - Ivory	07 - Pink	08 - Sky Blue
09 - Yellow	11 - Black	12 - Silver	13 - Gold	14 - Green
15 - Brown	17 - Bahama beige	18 - Grey		

## AVAILABLE MINIMUM QUANTITY 800 PCS by colour and height (Price to be agreed. Production delay 4/5 weeks)

10 - Red	16 - Blue	19 - Beige	20 - Dark ivory
21 - Light pink	22 - Dark pink	23 - Dark antique pink	24 - Dark sky blue
25 - Brick red	26 - Turquoise green	27 - Dark green	28 - Hazel brown
29 - Dark brown			

# CAPSULES for three-ways joints

POLYPROPYLENE/POLYETHYLENE UV RESISTANT

\* Capsules & end caps of the on demand profiles are also on demand

## POLYPROPYLENE / POLYETHYLENE UV RESISTANT

Article	H mm	Pack. 20 pcs	Pack. 5 pcs
CPJ 06-.../...	6		
IPJ 06-.../...	6		
CPJ 08-.../...	8		
IPJ 08-.../...	8		
CPJ 10-.../...	10		
IPJ 10-.../...	10		
CPJ 125-.../...	12,5		
IPJ 125-.../...	12,5		

### EXTERNAL CAPSULES



CPJ ...-.../...

### INTERNAL CAPSULES



IPJ ...-.../...

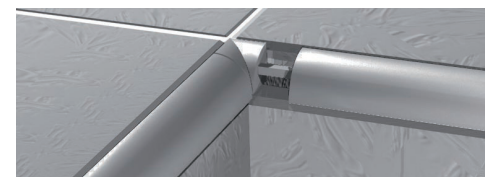

Available in the colours: 01-02-03-04-05-06-07-08-09-10-11-12-13-14-15-16-17-18-0106 (not available 19-20-21-22-23-24-25-26-27-28-29).  
The code of the selected colour must be added to the article code.  
E.g.: CPJ 06-.../... (chosen colour white) CPJ 06-01/20.

\* = Production on demand with minimum quantity of 800 pcs. Production delay 4/5 weeks. Price to be agreed

**PROJOLLY MARBLE** is a rounded bead profile in shockproof non - toxic marbled vinyl resin that can be applied on external corners of coverings. It can be used to close the perimeter of coverings. Its particular section, the availability of different marble effect finishes also on demand and special pieces such as internal and external corners make **PROJOLLY MARBLE** a much sought-after profile. It can be easily matched with the wall covering and allows an elegant workmanlike application.

# PROJOLLY MARBLE

SHOCKPROOF NON - TOXIC MARBLED VINYL RESIN



**MARBLED NON-TOXIC VYNIL RESIN**  
bar length 2,7 lm - pack. 40 Pcs - 108 lm

Article	H mm
PJ... 06	6
PJ... 08	8
PJ... 10	10
PJ... 125	12,5

Available on demand MC - MB - MR - MA - MV - MVA - MAS - MBS - MRS - MVAS - MTC - MTS (MAB - MBC - MBO - MAM - MBD - MCRI - MCRC - MBDX - MGVC - MGV - MNA - MBPS - MVBL with a minimum quantity order of 800 pcs).

The code of the selected colour must be added to the article code. E.g.: PJ... 10 (chosen colour carrara) PJMC 10.

### INSTRUCTIONS FOR LAYING

1. Choose "PROJOLLY MARBLE" according to the tile thickness and desired colour. 2. Cut "PROJOLLY MARBLE" to the desired length and apply the adhesive on the support where the profile will be laid. 3. Press the anchoring flange of "PROJOLLY MARBLE" into the adhesive. 4. Lay the tiles, aligning them with the profile leaving a 2 mm joint. 5. Fill the joints between the profile and the tiles with grout, in order to avoid water stagnation.

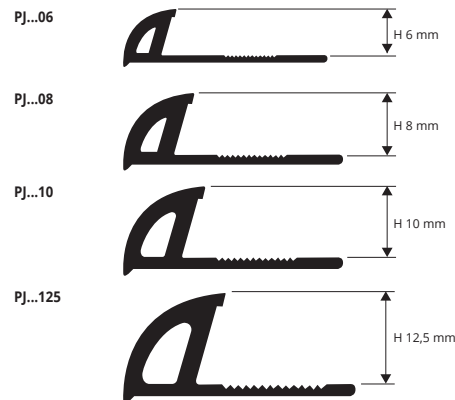

### EXAMPLES OF LAYING

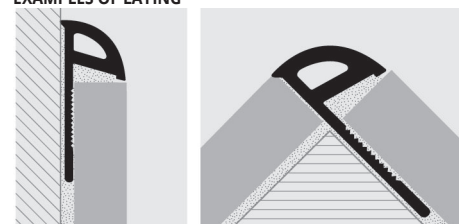

### COLOURS



**AVAILABLE MINIMUM QUANTITY 800 PCS** by colour and height (Price to be agreed. Production delay 4/5 weeks)



**PROJOLLY OPEN** is a rounded bead profile in shockproof non - toxic marbled vinyl resin that can be applied on external corners of coverings. It can be used to close the perimeter of coverings. Its particular open section and the availability in white colour make **PROJOLLY OPEN** a practical and economic profile. It can be used where low cost and workmanlike application are required.

# PROJOLLY OPEN

SHOCKPROOF NON - TOXIC WHITE VINYL RESIN



**WHITE VINYL RESIN**  
bar length 2,7 lm - pack. 80 Pcs - 216 lm

Article	H mm
PJP 06-01	6
PJP 09-01	9

ARTICLES NOT FOR SALE SINGLY

### INSTRUCTIONS FOR LAYING

1. Choose "PROJOLLY OPEN" according to the tile thickness. 2. Cut "PROJOLLY OPEN" to the desired length and apply the adhesive on the support where the profile will be laid. 3. Press the anchoring flange of "PROJOLLY OPEN" into the adhesive. 4. Lay the tiles, aligning them with the profile leaving a 2 mm joint. 5. Fill the joints between the profile and the tiles with grout, in order to avoid water stagnation.

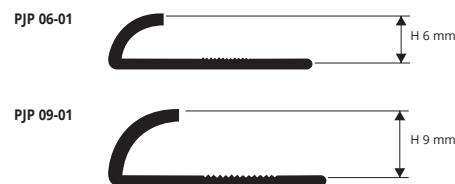

### EXAMPLES OF LAYING

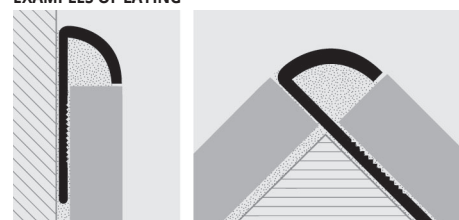

### COLOURS

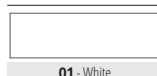

OTHER COLOURS ON DEMAND FOR A MINIMUM OF 800 pcs

\* = Production on demand with minimum quantity of 800 pcs. Production delay 4/5 weeks. Price to be agreed

# PROJOLLY ECO

SHOCKPROOF NON - TOXIC  
COLOURED VINYL RESIN

**PROJOLLY ECO** is a rounded bead profile in shockproof non - toxic colored vinyl resin that can be applied on external corners of coverings. It can be used to close the perimeter of coverings. Its particular section, the availability of different colours also on demand and special pieces such as internal and external corners make **PROJOLLY ECO** a practical and economic profile. It can be easily matched with the wall covering and allows an elegant workmanlike application.

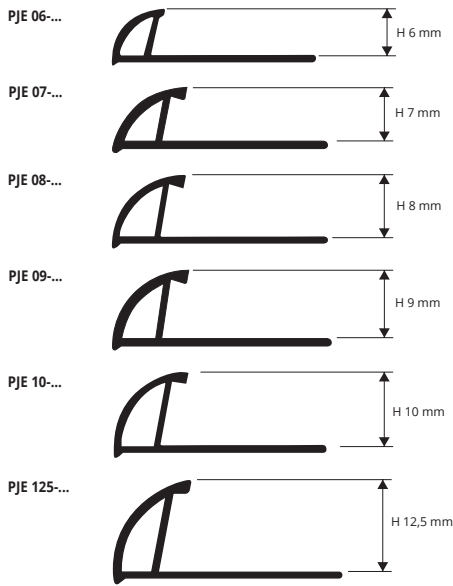

**COLOURED VINYL RESIN**  
bar length 2,7 lm - pack. 80 Pcs - 216 lm

Article	H mm		
PJE 06-01/06/18	6		*
PJE 08-...	8		
PJE 10-...	10		
PJE 125-...	12,5		

ARTICLES NOT FOR SALE SINGLY

H 6 mm available the colours 01 - 06 - 18, other colours on demand.  
Available on demand in the colours 01 - 02 - 03 - 04 - 05 - 06 - 07 - 08 - 09 - 10 - 11 - 12 - 13 - 14 - 15 - 16 - 17 - 18 (0106 - 19 - 20 - 21 - 22 - 23 - 24 - 25 - 26 - 27 - 28 - 29 with a minimum quantity order of 800 pcs. The code of the selected colour must be added to the article code. E.g.: PJE 08... (chosen colour white) PJE 08-01.

**COLOURED VINYL RESIN**  
bar length 2,7 lm - pack. 80 Pcs - 216 lm

Article	H mm		
PJE 07-...	7		*
PJE 09-...	9		*

ARTICLES NOT FOR SALE SINGLY

PRODUCTION ON DEMAND  
MINIMUM QUANTITY 800 PCS BY COLOUR AND HEIGHT  
(Production delay 4/5 weeks)

Available on demand in the colours: 01 - 02 - 03 - 04 - 05 - 06 - 07 - 08 - 09 - 10 - 11 - 12 - 13 - 14 - 15 - 16 - 17 - 18 - 19 - 20 - 21 - 22 - 23 - 24 - 25 - 26 - 27 - 28 - 29 - 0106 with a minimum quantity order of 800 pcs. The code of the selected colour must be added to the article code. E.g.: PJE 07... (chosen colour white) PJE 07-01.

## EXAMPLES AND INSTRUCTIONS FOR LAYING METHODS

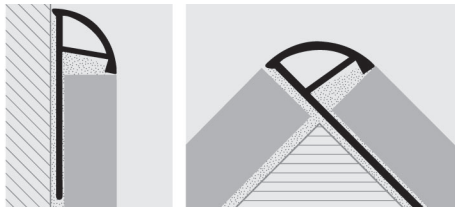

1. Choose "PROJOLLY ECO" according to the tile thickness and desired colour. 2. Cut "PROJOLLY ECO" to the desired length and apply the adhesive on the support where the profile will be laid. 3. Press the anchoring flange of "PROJOLLY ECO" into the adhesive. 4. Lay the tiles, aligning them with the profile leaving a 2 mm joint. 5. Fill the joints between the profile and the tiles with grout, in order to avoid water stagnation.

## COLOURS

01 - White	02 - Light grey	03 - Cement gray	04 - Light beige	05 - Dark beige	06 - Ivory
07 - Pink	08 - Sky blue	09 - Yellow	10 - Red	11 - Black	12 - Silver
13 - Gold	14 - Green	15 - Brown	16 - Blue	17 - Bahama beige	18 - Grey

AVAILABLE MINIMUM QUANTITY 800 PCS by colour and height  
(Price to be agreed. Production delay 4/5 weeks)

0106 - White ivory	19 - Beige	20 - Dark ivory
21 - Light pink	22 - Dark pink	23 - Dark antique pink
24 - Dark sky blue	25 - Brick red	26 - Turquoise green
27 - Dark green	28 - Hazel brown	29 - Dak brown

# CAPSULES for three-ways joints

COLOURED PLASTIC

\* Capsules & end caps of the on demand profiles are also on demand



EXTERNAL CAPSULES



CPJE ...-.../...

COLOURED PLASTIC

Article	H mm	Pack. 20 pcs	Pack. 5 pcs
CPJE 06-01/06/18/...	6		
CPJE 08-.../...	8		
CPJE 10-.../...	10		
CPJE 125-.../...	12,5		

ARTICLES NOT FOR SALE SINGLY

H 6 mm available the colours 01 - 06 - 18, other colours on demand.  
Available in the colours: 01 - 02 - 03 - 04 - 05 - 06 - 07 - 08 - 09 - 10 - 11 - 12 - 13 - 14 - 15 - 16 - 17 - 18 (not available 0106 - 19 - 20 - 21 - 22 - 23 - 24 - 25 - 26 - 27 - 28 - 29).  
The code of the selected colour must be added to the article code. E.g.: CPJE 08-.../... (chosen colour white) CPJE 08-01/20.

\* = Production on demand with minimum quantity of 800 pcs. Production delay 4/5 weeks. Price to be agreed

**PROJOLLY ECO MARBLE** is a rounded bead profile in shockproof non - toxic marbled vinyl resin that can be applied on external corners of coverings. It can be used to close the perimeter of coverings. Its particular section and the availability of different marble effect finishes, also on demand, and special pieces such as internal and external corners make **PROJOLLY ECO MARBLE** a much sought-after profile. It can be easily matched with the wall covering and allows an elegant workmanlike application.

# PROJOLLY ECO MARBLE

SHOCKPROOF NON - TOXIC  
MARBLED VINYL RESIN



**SHOCKPROOF MARBLED VINYL RESIN**  
bar length 2,7 lm - pack. 80 Pcs - 216 lm

Article	H mm		
PJE... 06	6		*
PJE... 08	8		
PJE... 10	10		

**ARTICLES NOT FOR SALE SINGLY**

PJE... 125 available on demand.  
Available in the colours: MC - MB - MR - MA - MV - MVA - MAS - MBS - MRS - MVAS - MTC - MTS ( on demand MAB - MBC - MBO - MAM - MBD - MCRI - MCRC - MBDX - MGVC - MNA - MBPS - MVBL with a minimum quantity order of 800 pcs).  
The code of the selected colour must be added to the article code.  
E.g.: PJE... 06 (chosen colour carrara) PJEMC 06.

**SHOCKPROOF MARBLED VINYL RESIN**  
bar length 2,7 lm - pack. 80 Pcs - 216 lm

Article	H mm		
PJE... 07	7		*
PJE... 09	9		*

**ARTICLES NOT FOR SALE SINGLY**

**PRODUCTION ON DEMAND**  
**MINIMUM QUANTITY 800 PCS BY COLOUR AND HEIGH**  
(Production delay 4/5 weeks)

Available on demand in the colours: MC - MB - MR - MA - MV - MVA - MAS - MBS - MRS - MVAS - MTC - MTS - MAB - MBC - MBO - MAM - MBD - MCRI - MCRC - MBDX - MGVC - MNA - MBPS - MVBL with a minimum quantity order of 800 pcs.  
The code of the selected colour must be added to the article code.  
E.g.: PJE... 06 (chosen colour carrara) PJEMC 06.

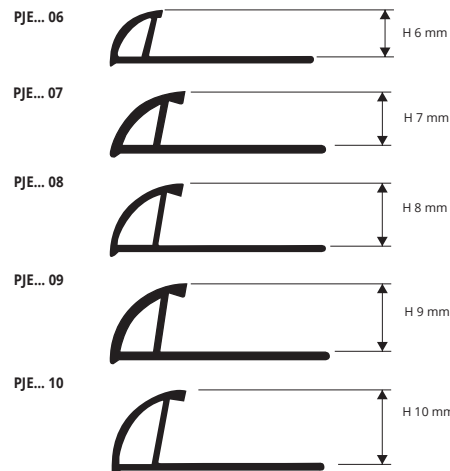

**EXAMPLES AND INSTRUCTIONS FOR LAYING METHODS**



1. Choose "PROJOLLY ECO MARBLE" according to the tile thickness and desired finish.
2. Cut "PROJOLLY ECO MARBLE" to the desired length and apply the adhesive on the support where the profile will be laid.
3. Press the anchoring flange of "PROJOLLY ECO MARBLE" into the adhesive.
4. Lay the tiles, aligning them with the profile leaving a 2 mm joint.
5. Fill the joints between the profile and the tiles with grout, in order to avoid water stagnation.

**COLOURS**



**AVAILABLE MINIMUM QUANTITY 800 PCS** by colour and height (Price to be agreed. Production delay 4/5 weeks)

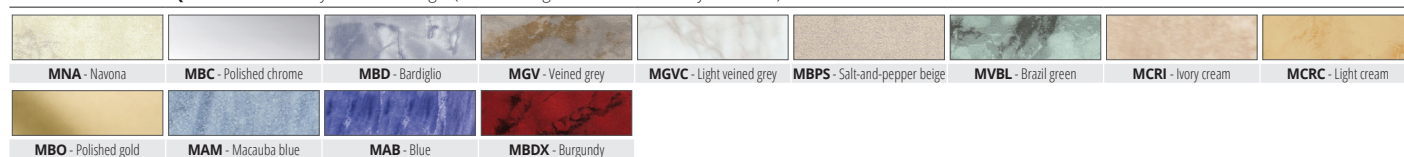

\* = Production on demand with minimum quantity of 800 pcs. Production delay 4/5 weeks. Price to be agreed

# PROJOLLY TRIANGLE

POLISHED, SUPER POLISHED AND BRUSHED STAINLESS STEEL AISI 304/1.4301-V2A

**PROJOLLY TRIANGLE** is a triangle-shaped bead profile polished, super polished and brushed stainless steel AISI 304/1.4301-V2A that can be applied on external corners of coverings. It can be used to close the perimeter of coverings and like a connection profile between step tread and riser of stairs coated with ceramic or natural stone tiles. Its particular section, the availability in three different finishes and special pieces such as internal and external corners, end caps and joints make **PROJOLLY TRIANGLE** a much sought-after profile that allows a workmanlike application even in environments subject to high mechanical stresses.

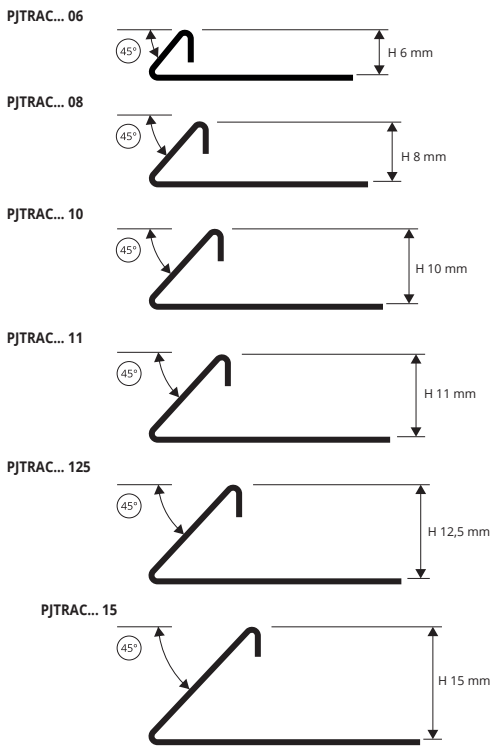

**POLISHED STAINLESS STEEL AISI 304/1.4301-V2A with protective film**  
bar length 2,7 lm - pack. 20 Pcs - 54 lm - 8/10 mm

Article	H mm
PJTRAC 06	6
PJTRAC 08	8
PJTRAC 10	10
PJTRAC 11	11
PJTRAC 125	12,5
PJTRAC 15	15

**BRUSHED STAINLESS STEEL AISI 304/1.4301-V2A**  
bar length 2,7 lm - pack. 20 Pcs - 54 lm - 8/10 mm

Article	H mm
PJTRACS 06	6
PJTRACS 08	8
PJTRACS 10	10
PJTRACS 11	11
PJTRACS 125	12,5
PJTRACS 15	15

**SUPER POLISHED STAINLESS STEEL AISI 304/1.4301-V2A thermo packed**  
bar length 2,7 lm - pack. 20 Pcs - 54 lm - 8/10 mm

Article	H mm
PJTRACML 06	6
PJTRACML 08	8
PJTRACML 10	10
PJTRACML 11	11
PJTRACML 125	12,5
PJTRACML 15	15



#### COLOURS

AC	ACML	ACS
Polished stainless steel AISI 304/1.4301-V2A	Super polished stainless steel AISI 304/1.4301-V2A	Brushed stainless steel AISI 304/1.4301-V2A

#### EXAMPLES AND INSTRUCTIONS FOR LAYING METHODS

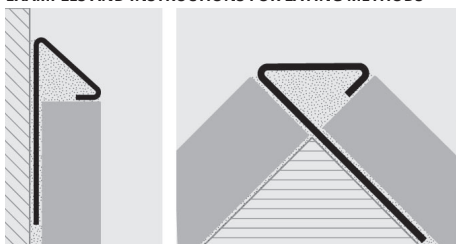

1. Choose "PROJOLLY TRIANGLE" according to the tile thickness and desired finish.
2. Cut "PROJOLLY TRIANGLE" to the desired length and apply the adhesive on the support where the profile will be laid.
3. Press the anchoring flange of "PROJOLLY TRIANGLE" into the adhesive.
4. Lay the tiles, aligning them with the profile leaving a 2 mm joint. Remove immediately all remains of adhesive from the surface of the profile.
5. Fill the joints between the profile and the tiles with grout, in order to avoid water stagnation. Remove immediately all the remains of grout from the surface of the profile.

SUITABLE FOR USE IN CONTACT WITH FOODSTUFFS.

## CAPSULES, END CAPS, THREE-WAYS JOINTS and JOINTS

POLISHED, SUPER POLISHED AND BRUSHED STAINLESS STEEL AISI 304/1.4301-V2A / PLASTIC

#### EXTERNAL / INTERNAL / THREE-WAYS CAPSULES and END CAPS - POLISHED STAINLESS STEEL

Article	H mm	Pack. 10 pcs	Pack. 2 pcs
CPJTRAC .../...	06-08-10-11-12,5-15		
IPJTRAC .../...	06-08-10-11-12,5-15		
CTPJTRAC .../...	06-08-10-11-12,5-15		
TPJTRAC .../...	06-08-10-11-12,5-15		

Choose the desired packaging: E.g.: CPJTRAC.../10 (Pack. 10 Pcs)  
CPJTRAC.../2 (Pack. 2 Pcs)

ARTICLES NOT FOR SALE SINGLY

#### EXTERNAL / INTERNAL / THREE-WAYS CAPSULES and END CAPS - SUPER POLISHED STAINLESS STEEL

Article	H mm	Pack. 10 pcs	Pack. 2 pcs
CPJTRACML .../...	06-08-10-11-12,5-15		
IPJTRACML .../...	06-08-10-11-12,5-15		
CTPJTRACML .../...	06-08-10-11-12,5-15		
TPJTRACML .../...	06-08-10-11-12,5-15		

Choose the desired packaging: E.g.: CPJTRACML.../10 (Pack. 10 Pcs)  
CPJTRACML.../2 (Pack. 2 Pcs)

ARTICLES NOT FOR SALE SINGLY

#### EXTERNAL / INTERNAL / THREE-WAYS CAPSULES and CAPS - BRUSHED STAINLESS STEEL

Article	H mm	Pack. 10 pcs	Pack. 2 pcs
CPJTRACS .../...	06-08-10-11-12,5-15		
IPJTRACS .../...	06-08-10-11-12,5-15		
CTPJTRACS .../...	06-08-10-11-12,5-15		
TPJTRACS .../...	06-08-10-11-12,5-15		

Choose the desired packaging: E.g.: CPJTRACS.../10 (Pack. 10 Pcs)  
CPJTRACS.../2 (Pack. 2 Pcs)

ARTICLES NOT FOR SALE SINGLY

#### JOINTS - PLASTIC

Article	H mm	Pack. 10 pcs	Pack. 2 pcs
GJTRA .../...	06-08-10-11-12,5-15		

Choose the desired packaging: E.g.: GJTRA.../10 (Pack. 10 Pcs)  
GJTRA.../2 (Pack. 2 Pcs)

ARTICLES NOT FOR SALE SINGLY

#### EXTERNAL CAPSULE INTERNAL CAPSULE THREE-WAYS CAPSULE END CAPS JOINTS



**PROJOLLY TRIANGLE** is a triangle-shaped bead profile in brass that can be applied on external corners of coverings. It can be used to close the perimeter of coverings and like a connection profile between step tread and riser of stairs coated with ceramic or natural stone tiles. Its particular section, the availability in different finishes make **PROJOLLY TRIANGLE** a much sought-after profile that allows an elegant workmanlike application.

# PROJOLLY TRIANGLE

NATURAL, POLISHED VARNISHED, CHROMED AND ANTIQUE BRASS

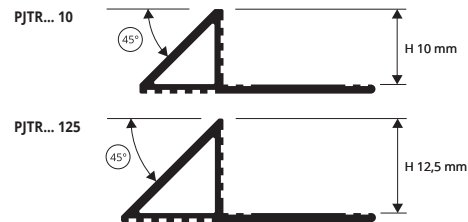

**NATURAL BRASS thermo packed**  
bar length 2,7 lm - pack. 20 Pcs - 54 lm

Article	H mm
PJTRON 10	10
PJTRON 125	12,5

**SUPER POLISHED CHROMED BRASS thermo packed** bar length 2,7 lm - pack. 20 Pcs - 54 lm



Article	H mm
PJTROC 10	10
PJTROC 125	12,5

**POLISHED VARNISHED BRASS thermo packed**  
bar length 2,7 lm - pack. 20 Pcs - 54 lm

Article	H mm
PJTROL 10	10
PJTROL 125	12,5

**ANTIQU BRASS thermo packed**  
bar length 2,7 lm - pack. 20 Pcs - 54 lm

Article	H mm
PJTROB 10	10
PJTROB 125	12,5

## EXAMPLES AND INSTRUCTIONS FOR LAYING METHODS

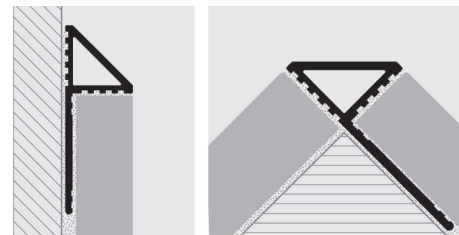

1. Choose "PROJOLLY TRIANGLE" according to the tile thickness and desired finish.
2. Cut "PROJOLLY TRIANGLE" to the desired length and apply the adhesive on the support where the profile will be laid.
3. Press the anchoring flange of "PROJOLLY TRIANGLE" into the adhesive.
4. Lay the tiles, aligning them with the profile leaving a 2 mm joint. Remove immediately all remains of adhesive from the surface of the profile.
5. Fill the joints between the profile and the tiles with grout, in order to avoid water stagnation. Remove immediately all the remains of grout from the surface of the profile.

## COLOURS



# PROJOLLY TRIANGLE

ANODIZED, POLISHED AND BRUSHED ALUMINIUM

**PROJOLLY TRIANGLE** is a triangle-shaped bead profile in anodized, polished and brushed aluminium that can be applied on external corners of coverings. It can be used to close the perimeter of coverings and like a connection profile between step tread and riser of stairs coated with ceramic or natural stone tiles. Its particular section, the availability in seven different finishes and special pieces such as internal and external corners, end caps and joints make **PROJOLLY TRIANGLE** a much sought-after profile that allows an elegant workmanlike application.

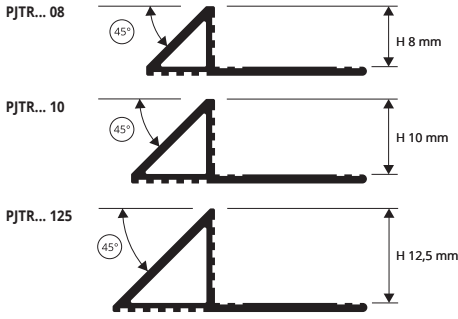

## EXAMPLES AND INSTRUCTIONS FOR LAYING METHODS

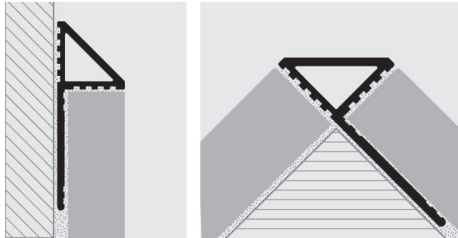

1. Choose "PROJOLLY TRIANGLE" according to the tile thickness and desired finish. 2. Cut "PROJOLLY TRIANGLE" to the desired length and apply the adhesive on the support where the profile will be laid. 3. Press the anchoring flange of "PROJOLLY TRIANGLE" into the adhesive. 4. Lay the tiles, aligning them with the profile leaving a 2 mm joint. Remove immediately all remains of adhesive from the surface of the profile. 5. Fill the joints between the profile and the tiles with grout, in order to avoid water stagnation. Remove immediately all the remains of grout from the surface of the profile.

**ANODIZED ALUMINIUM** (silver - titanium - gold) thermo packed  
bar length 2,7 lm - pack. 40 Pcs - 108 lm

Article	H mm
PJTRAA 08	8
PJTRAA 10	10
PJTRAA 125	12,5
PJTRAT 08	8
PJTRAT 10	10
PJTRAT 125	12,5
PJTRAO 08	8
PJTRAO 10	10
PJTRAO 125	12,5

**POLISHED ALUMINIUM** (chrome - titanium - gold) thermo packed  
bar length 2,7 lm - pack. 40 Pcs - 108 lm

Article	H mm
PJTRBC 08	8
PJTRBC 10	10
PJTRBC 125	12,5
PJTRBT 08	8
PJTRBT 10	10
PJTRBT 125	12,5
PJTRBO 08	8
PJTRBO 10	10
PJTRBO 125	12,5

**BRUSHED POLISHED ALUMINIUM** (silver - gold) thermo packed  
bar length 2,7 lm - pack. 40 Pcs - 108 lm

Article	H mm
PJTRBS 08	8
PJTRBS 10	10
PJTRBS 125	12,5
PJTRBOS 08	8
PJTRBOS 10	10
PJTRBOS 125	12,5

ON DEMAND MAY BE REALISED IN OTHER FINISHES OF THE COLOUR CHART.

CONTACT OUR CUSTOMER SERVICE FOR MINIMAL QUANTITY, TIMING AND PRICE.

## COLOURS

ANODIZED			POLISHED			BRUSHED POLISHED	
AA - Anodized silver alum.	AT - Anodized titanium alum.	AO - Anodized gold alum.	BC - Polished chrome alum.	BT - Polished titanium alum.	BO - Polished gold alum.	BS - Brushed pol. silver alum.	BOS - Brushed pol. gold alum.

# CAPSULES, END CAPS, THREE-WAYS JOINTS and JOINTS

\* Capsules & end caps of the on demand profiles are also on demand

ANODIZED, POLISHED, BRUSHED POLISHED ALUMINIUM

## CAPSULES, END CAPS, THREE-WAYS - ANODIZED ALUMINIUM

Article	H mm	Pack 10 Pcs	Pack 2 Pcs
CPJTRAA .../...	08/10/125		
IPJTRAA .../...	08/10/125		
TPJTRAA .../...	08/10/125		
CPJTRAT .../...	08/10/125		
IPJTRAT .../...	08/10/125		
TPJTRAT .../...	08/10/125		
CPJTRAO .../...	08/10/125		
IPJTRAO .../...	08/10/125		
TPJTRAO .../...	08/10/125		

Choose the desired pack. & height  
Ex.: 4,5 mm capsule in 10 Pcs Pack - CPJTRAA 10/10

## CAPSULES, END CAPS, THREE-WAYS - POLISHED ALUM.

Article	H mm	Pack 10 Pcs	Pack 2 Pcs
CPJTRBC .../...	08/10/125		
IPJTRBC .../...	08/10/125		
TPJTRBC .../...	08/10/125		
CPJTRBT .../...	08/10/125		
IPJTRBT .../...	08/10/125		
TPJTRBT .../...	08/10/125		
CPJTRBO .../...	08/10/125		
IPJTRBO .../...	08/10/125		
TPJTRBO .../...	08/10/125		

Choose the desired pack. & height  
Ex.: 4,5 mm capsule in 10 Pcs Pack - CPJTRBC 10/10

## CAPSULES, END CAPS, THREE-WAYS - BRUSHED POLISHED ALUM.

Article	H mm	Pack 10 Pcs	Pack 2 Pcs
CPJTRBS .../...	08/10/125		
IPJTRBS .../...	08/10/125		
TPJTRBS .../...	08/10/125		
CPJTRBOS .../...	08/10/125		
IPJTRBOS .../...	08/10/125		
TPJTRBOS .../...	08/10/125		

Choose the desired pack. & height  
Ex.: 4,5 mm capsule in 10 Pcs Pack - CPJTRBS 10/10

## JOINTS - PLASTIC

Article	H mm	Pack 10 Pcs	Pack 2 Pcs
GIJTRA .../...	08/10/125		

Choose the desired pack. & height  
Ex.: 10 mm joint in 10 Pcs Pack - GIJTRA 10/10



\* = Production on demand with minimum quantity of 100 pcs. Production delay 4/5 weeks. Price to be agreed



**PROJOLLY ANGLE 135** is a polished and satin stainless steel profile that can be used as protection for the 135° corners of coverings. Its particular section, the availability in two different finishes make **PROJOLLY ANGLE 135** a much sought-after profile that allows an elegant workmanlike application.

# PROJOLLY ANGLE 135

POLISHED AND BRUSHED STAINLESS STEEL AISI 304/1.4301-V2A



**POLISHED STAINLESS STEEL AISI 304/1.4301-V2A with protective film**  
bar length 2,7 lm - pack. 20 Pcs - 54 lm - 10/10 mm

Article	H mm
PJTR135AC 08	8
PJTR135AC 10	10
PJTR135AC 11	11
PJTR135AC 125	12,5

**BRUSHED STAINLESS STEEL AISI 304/1.4301-V2A with protective film**  
bar length 2,7 lm - pack. 20 Pcs - 54 lm - 10/10 mm

Article	H mm
PJTR135ACS 08	8
PJTR135ACS 10	10
PJTR135ACS 11	11
PJTR135ACS 125	12,5

## COLOURS



**AC** - Polished stainless steel AISI 304/1.4301-V2A  
**ACS** - Brushed stainless steel AISI 304/1.4301-V2A

SUITABLE FOR USE IN CONTACT WITH FOODSTUFFS

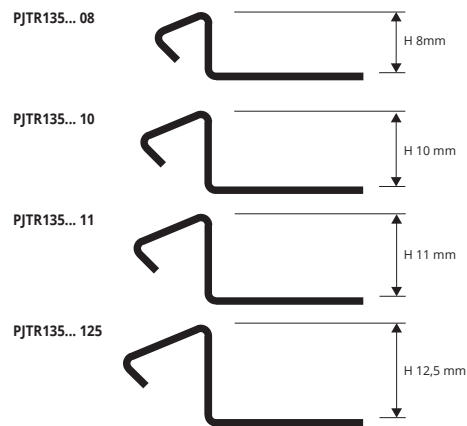

## EXAMPLES AND INSTRUCTIONS FOR LAYING METHODS

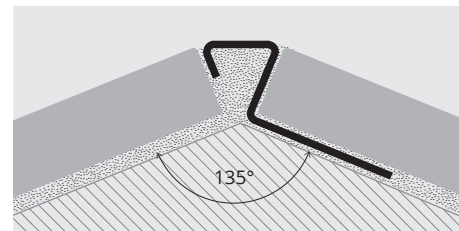

1. Choose "PROJOLLY ANGLE 135" according to the tile thickness and desired finish.
2. Cut "PROJOLLY ANGLE 135" to the desired length and apply the adhesive on the support where the profile will be laid.
3. Press the anchoring flange of "PROJOLLY ANGLE 135" into the adhesive.
4. Lay the tiles, aligning them with the profile leaving a 2 mm joint. Remove immediately all remains of adhesive from the surface of the profile.
5. Fill the joints between the profile and the tiles with grout, in order to avoid water stagnation. Remove immediately all the remains of grout from the surface of the profile.



# PROINTER AC

POLISHED, SUPER POLISHED AND BRUSHED STAINLESS STEEL AISI 304/1.4301-V2A

**PROINTER AC** is a cove-shaped profile in polished, super polished and brushed stainless steel AISI 304 / 1.4301 - V2A. It is particularly suitable to ensure cleanliness and hygiene in every kind of environment where high resistance to mechanical and chemical stresses are required. Its particular section and the availability in three finishes and special pieces, such as internal and external corners, make **PROINTER AC** a much sought after profile. The profile is easy to match with the wall covering and allows a workmanlike application even in environments subject to high mechanical stresses.

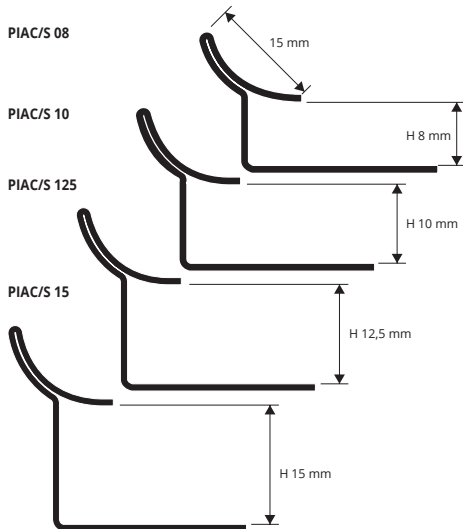

## EXAMPLES AND INSTRUCTIONS FOR LAYING METHODS

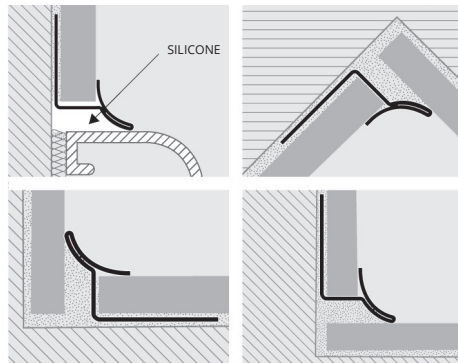

1. Choose "PROINTER AC" according to the tile thickness and desired finish.
2. Cut "PROINTER AC" to the desired length and apply the adhesive on the support where the profile will be laid.
3. Press the anchoring flange of "PROINTER AC" into the adhesive.
4. Lay the tiles, aligning them with the profile leaving a 2 mm joint. Remove immediately all remains of adhesive from the surface of the profile.
5. Fill the joints between the profile and the tiles with grout, in order to avoid water stagnation. Remove immediately all the remains of grout from the surface of the profile.

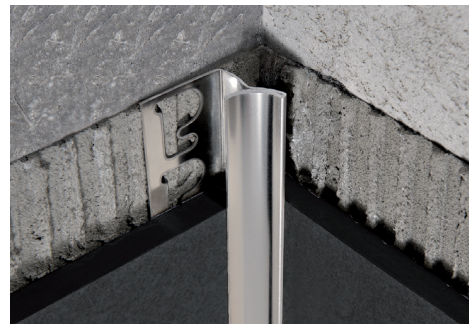

POLISHED STAINLESS STEEL AISI 304/1.4301 V2A with protective film  
bar length 2,7 lm - pack. 20 Pcs - 54 lm - 10/10 mm

Article	H mm
PIAC 08	8
PIAC 10	10
PIAC 125	12,5
PIAC 15	15

SUPER POLISHED STAINLESS STEEL AISI 304/1.4301-V2A  
thermo packed  
bar length 2,7 lm - pack. 20 Pcs - 54 lm - 10/10 mm

Article	H mm
PIACML 08	8
PIACML 10	10
PIACML 125	12,5
PIACML 15	15

## COLOURS



SUITABLE FOR USE IN CONTACT WITH FOODSTUFFS.

Corners of the on demand profiles are also on demand \*



BRUSHED STAINLESS STEEL AISI 304/1.4301 V2A with protective film  
bar length 2,7 lm - pack. 20 Pcs - 54 lm - 10/10 mm

Article	H mm
PIACS 08	8
PIACS 10	10
PIACS 125	12,5
PIACS 15	15

INTERNAL, EXTERNAL, THREE-WAYS PROINTER CORNER JOINTS  
POLISHED STAINLESS STEEL AISI 316/1.4404-V4A - pack. 2 Pcs

Article	Pack. 2 Pcs
REPIACM/2	
RIPIACM/2	
RITPIACM/2	

INTERNAL, EXTERNAL, THREE-WAYS PROINTER CORNER JOINTS  
BRUSHED STAINLESS STEEL AISI 316/1.4404-V4A - pack. 2 Pcs

Article	Pack. 2 Pcs
REPIACMS/2	
RIPIACMS/2	
RITPIACMS/2	



# PROINTER KL ACC

STAINLESS STEEL AISI 304/1.4301-V2A

**PROINTER KL ACC** is a cove-shaped profile in stainless steel AISI 304/1.4301-V2A. The profile allows to connect the floor and wall coverings in ceramic and mosaic also with low thickness. It is particularly suitable to ensure cleanliness and hygiene in every kind of environment where good resistance to mechanical and chemical stresses are required. Its particular section makes **PROSHELL KL ALL** a much sought after profile.

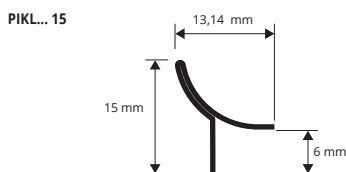

## EXAMPLES AND INSTRUCTIONS FOR LAYING METHODS

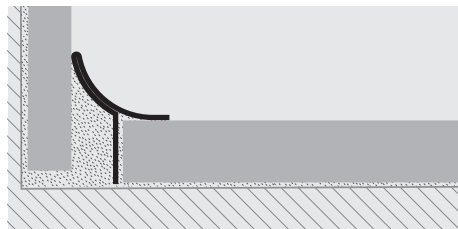

1. Choose "PROINTER KL ACC" according to the desired finish.
2. Cut "PROINTER KL ACC" to the desired length.
3. Apply the silicone along the floor-wall connection.
4. Press the arrowhead of "PROINTER KL ACC" into the silicone evenly until it is completely adherent to the floor and wall.

SUITABLE FOR USE IN CONTACT WITH FOODSTUFFS



POLISHED STAINLESS ST. AISI 304/1.4301-V2A with protective film  
bar length 2,7 lm - pack. 40 Pcs - 108 lm - 10/10mm

Article	H mm
PIKLAC 15	15

BRUSHED STAINLESS ST. AISI 304/1.4301-V2A with protective film  
bar length 2,7 lm - pack. 40 Pcs - 108 lm - 8/10mm

Article	H mm
PIKLACS 15	15

## COLOURS



SANDED STAINLESS ST. AISI 304/1.4301-V2A with protective film  
bar length 2,7 lm - pack. 40 Pcs - 108 lm - 10/10mm

Article	H mm
PIKLACSB 15	40,50

SUPER POLISHED ST. AISI 304/1.4301-V2A with protective film  
bar length 2,7 lm - pack. 40 Pcs - 108 lm - 10/10mm

Article	H mm
PIKLACML 15	15

## AVAILABLE MINIMUM QUANTITY 100 PCS



\* = Production on demand with minimum quantity of 100 pcs. Production delay 4/5 weeks. Price to be agreed

**PRINTER AC 316** is a cove-shaped profile in polished, super polished and brushed stainless steel AISI 316 / 1.404 - V4A. It is particularly suitable to ensure cleanliness and hygiene in every kind of environment where high resistance to mechanical and chemical stresses are required. Its particular section and the availability in three finishes and special pieces, such as internal and external corners, make **PRINTER AC 316** a much sought after profile. The profile is easy to match with the wall covering and allows a workmanlike application even in environments subject to high mechanical stresses.

# PRINTER AC

POLISHED AND BRUSHED STAINLESS STEEL  
AISI 316/1.4401-V4A



**POLISHED STAINLESS STEEL AISI 316/1.4404-V4A**  
bar length 2,7 lm - pack. 20 Pcs - 54 lm - 10/10 mm



**BRUSHED STAINLESS STEEL AISI 316/1.4404-V4A**  
bar length 2,7 lm - pack. 20 Pcs - 54 lm - 10/10 mm



Article	H mm		
PIACM 08	8		
PIACM 10	10		
PIACM 125	12,5		
PIACM 15	15		

Article	H mm		
PIACMS 08	8		
PIACMS 10	10		
PIACMS 125	12,5		
PIACMS 15	15		

**INTERNAL, EXTERNAL, THREE-WAYS PRINTER CORNER JOINTS**  
POLISHED STAINLESS STEEL AISI 316/1.4404-V4A - pack. 2 Pcs



Article	Pack. 2 Pcs
REPIACM/2	
RIPIACM/2	
RITPIACM/2	

**INTERNAL, EXTERNAL, THREE-WAYS PRINTER CORNER JOINTS**  
BRUSHED STAINLESS STEEL AISI 316/1.4404-V4A - pack. 2 Pcs



Article	Pack. 2 Pcs
REPIACMS/2	
RIPIACMS/2	
RITPIACMS/2	

## COLOURS



**ACM** - Polished stainless steel  
AISI 316/1.4404-V4A

**ACMS** - Brushed stainless steel  
AISI 316/1.4404-V4A

SUITABLE FOR USE IN CONTACT WITH FOODSTUFFS.

Corners of the on demand profiles are also on demand \*

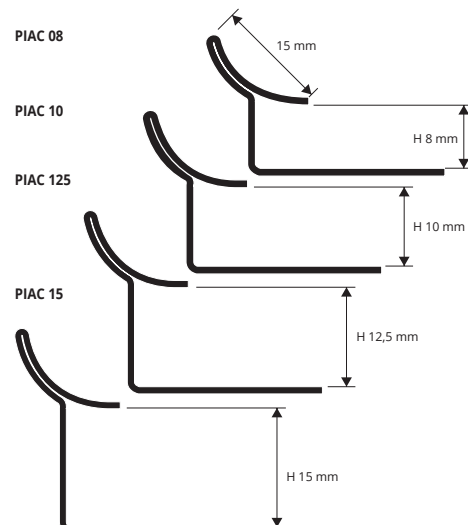

## EXAMPLES AND INSTRUCTIONS FOR LAYING METHODS

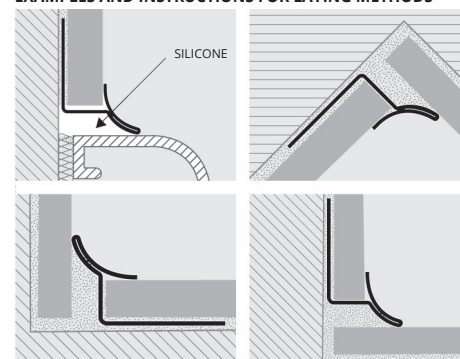

1. Choose "PRINTER AC 316" according to the tile thickness and desired finish.
2. Cut "PRINTER AC 316" to the desired length and apply the adhesive on the support where the profile will be laid.
3. Press the anchoring flange of "PRINTER AC 316" into the adhesive.
4. Lay the tiles, aligning them with the profile leaving a 2 mm joint. Remove immediately all remains of adhesive from the surface of the profile.
5. Fill the joints between the profile and the tiles with grout, in order to avoid water stagnation. Remove immediately all the remains of grout from the surface of the profile.

**PRINTER KL ACC 316** is a cove-shaped profile in stainless steel AISI 316/1.4404-V4A. The profile allows to connect the floor and wall coverings in ceramic and mosaic also with low thickness. It is particularly suitable to ensure cleanliness and hygiene in every kind of environment where good resistance to mechanical and chemical stresses are required. Its particular section makes **PROSHELL KL ALL 316** a much sought after profile.

# PRINTER KL ACC

STAINLESS STEEL AISI 316/1.4401-V4A

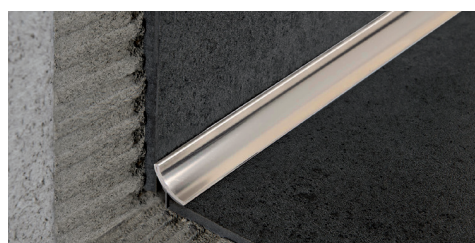

**POLISHED STAINLESS STEEL AISI 316/1.4404-V4A**  
bar length 2,7 lm - pack. 20 Pcs - 54 lm - 10/10 mm



**BRUSHED STAINLESS STEEL AISI 316/1.4404-V4A**  
bar length 2,7 lm - pack. 20 Pcs - 54 lm - 10/10 mm



Article	H mm		
PIKLACM 15	15		

Article	H mm		
PIKLACMS 15	15		

## COLOURS



**ACM** - Polished stainless steel  
AISI 316/1.4404-V4A

**ACMS** - Brushed stainless steel  
AISI 316/1.4404-V4A

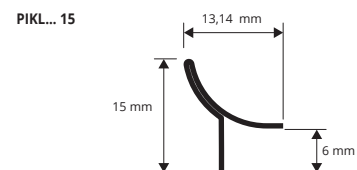

## EXAMPLES AND INSTRUCTIONS FOR LAYING METHODS

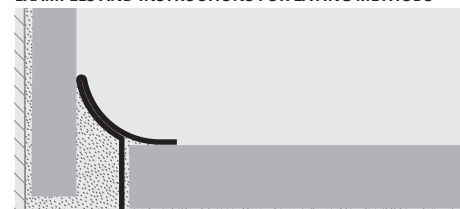

1. Choose "PRINTER KL ACC 316" according to the desired finish.
2. Cut "PRINTER KL ACC 316" to the desired length.
3. Apply the silicone along the floor-wall connection.
4. Press the arrowhead of "PRINTER KL ACC 316" into the silicone evenly until it is completely adherent to the floor and wall.

SUITABLE FOR USE IN CONTACT WITH FOODSTUFFS

# PROINTER AL

ANODIZED AND POLISHED ALUMINIUM

**PROINTER AL** is a cove-shaped profile in anodized and polished aluminium. It is particularly suitable to ensure cleanliness and hygiene is suitable in indoors environment where good resistance to mechanical and chemical stresses are required. Its particular section and the availability in four finishes and special pieces, such as internal and external corners, make **PROINTER AL** a much sought after profile. The profile is easy to match with the wall covering and allows a workmanlike application.

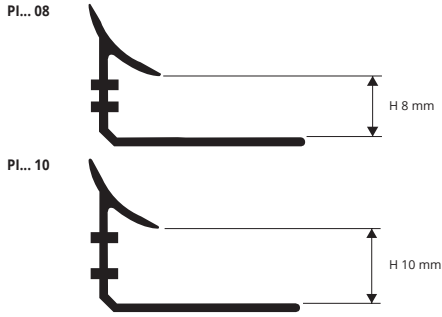

## EXAMPLES AND INSTRUCTIONS FOR LAYING METHODS

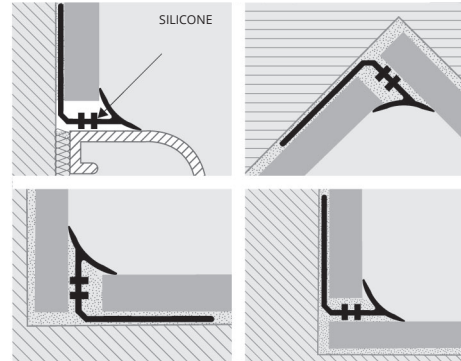

1. Choose "PROINTER AL" according to the tile thickness and desired finish.
2. Cut "PROINTER AL" to the desired length and apply the adhesive on the support where the profile will be laid.
3. Press the anchoring flange of "PROINTER AL" into the adhesive.
4. Lay the tiles, aligning them with the profile leaving a 2 mm joint. Remove immediately all remains of adhesive from the surface of the profile.
5. Fill the joints between the profile and the tiles with grout, in order to avoid water stagnation. Remove immediately all the remains of grout from the surface of the profile.



**ANODIZED GOLD OR SILVER ALUMINIUM thermo packed**  
bar length 2,7 lm - pack. 40 Pcs - 108 lm

Article	H mm		
PIAA 08	8		
PIAA 10	10		
PIAO 08	8		
PIAO 10	10		

**INTERNAL, EXTERNAL, THREE-WAYS PROINTER CORNER JOINTS**  
ANODIZED GOLD (AO) or SILVER ALUMINIUM (AA) - pack. 2 Pcs

Article	Pack. 2 Pcs
REPI.../2	
RIFI.../2	
RITPI.../2	

Corners of the on demand profiles are also on demand \*

## COLOURS

ANODIZED	
AA - Anodized silver alum.	AO - Anodized gold alum.
POLISHED	
BC - Polished chrome alum.	BO - Polished gold alum.

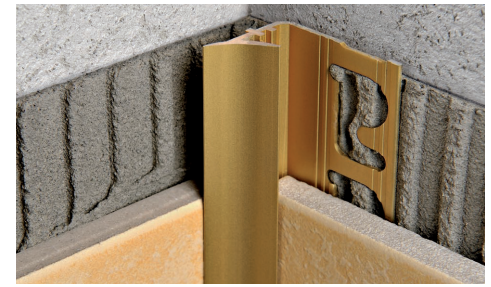

**POLISHED GOLD OR CHROMED ALUMINIUM thermo packed**  
bar length 2,7 lm - pack. 40 Pcs - 108 lm

Article	H mm		
PIBC 08	8		
PIBC 10	10		
PIBO 08	8		
PIBO 10	10		

**INTERNAL, EXTERNAL, THREE-WAYS PROINTER CORNER JOINTS**  
POLISHED GOLD (BO) or CHROMED ALUMINIUM (BC) - pack. 2 Pcs

Article	Pack. 2 Pcs
REPI.../2	
RIFI.../2	
RITPI.../2	

RITPI...



EXTERNAL CORNER  
PROTERMINAL, PROJOLLY SQUARE, PROJOLLY QUART (NO PROINTER)

RIFI...

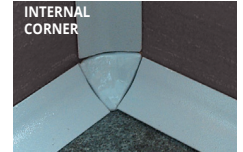

INTERNAL CORNER

# PROINTER KL ALL

POLISHED AND CHROMED BRASS AND ANODIZED AND POLISHED ALUMINIUM

**PROSHELL KL ALL** is a cove-shaped profile in polished and chromed brass and anodized and polished aluminium. The profile allows to connect the floor and wall coverings in ceramic and mosaic also with low thickness. It is particularly suitable to ensure cleanliness and hygiene in every kind of environment where good resistance to mechanical and chemical stresses are required. Its particular section and availability in five different finishes, make **PROSHELL KL ALL** a much sought after profile.

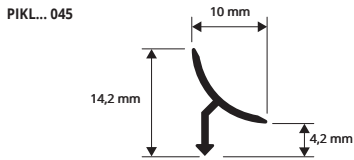

## EXAMPLES AND INSTRUCTIONS FOR LAYING METHODS

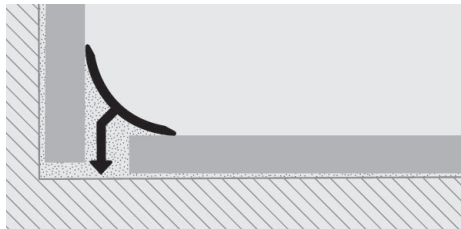

1. Choose "PROINTER KL ALL" according to the desired finish.
2. Cut "PROINTER KL ALL" to the desired length.
3. Apply the silicone along the floor-wall connection.
4. Press the arrowhead of "PROINTER KL ALL" into the silicone evenly until it is completely adherent to the floor and wall.



**POLISHED / CHROMED BRASS thermo packed**  
bar length 2,7 lm - pack. 40 Pcs - 108 lm

Article	H mm		
PIKLOL 045	4,5		
PIKLOC 045	4,5		

**CAPS - VARNISHED PLASTIC**

Article	Pack. 2 Pcs	Pack. 10 Pcs
TPIKL .../...		

## COLOURS

OL - Polished brass	OC - Chromed brass
---------------------	--------------------



**POLISHED CHROME ALUMINIUM / GOLD thermo packed**  
bar length 2,7 lm - pack. 40 Pcs - 108 lm

Article	H mm		
PIKLBC 045	4,5		
PIKLBO 045	4,5		

**ANODIZED SILVER ALUMINIUM thermo packed**  
bar length 2,7 lm - pack. 40 Pcs - 108 lm

Article	H mm		
PIKLAA 045	4,5		

**CAPS - VARNISHED PLASTIC**

Article	Pack. 2 Pcs	Pack. 10 Pcs
TPTPIKL .../...		

## COLOURS

AA - Anodized silver alum.	BC - Polished chrome alum.	BO - Polished gold alum.
----------------------------	----------------------------	--------------------------

Corners of the on demand profiles are also on demand \*

\* = Production on demand with minimum quantity of 100 pcs. Production delay 4/5 weeks. Price to be agreed



**PROINTER** is a cove-shaped profile in shockproof non-toxic colored vinyl resin. It is particularly suitable to ensure cleanliness and hygiene in public and industrial environments. Its particular section and the availability in twelve colours and special pieces, such as internal and external corners, make **PROINTER** a much sought after profile. It can be easily matched with the wall covering and allows an elegant workmanlike application.

# PROINTER

SHOCKPROOF NON - TOXIC COLORED VINYL RESIN



EXAMPLES AND INSTRUCTIONS FOR LAYING METHODS

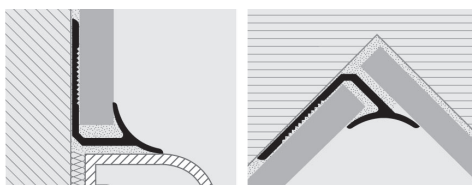

1. Choose "PROINTER" according to the tile thickness and desired colour.
2. Cut "PROINTER" to the desired length and apply the adhesive on the support where the profile will be laid.
3. Press the anchoring flange of "PROINTER" into the adhesive.
4. Lay the tiles, aligning them with the profile leaving a 2 mm joint.
5. Fill the joints between the profile and the tiles with grout, in order to avoid water stagnation.

**NON-TOXIC SHOCKPROOF VINYL RESIN**  
bar length 2,7 lm - pack. 20 Pcs - 54 lm (white 108 lm)

Article	H mm
PI 06-01	6
PI 07-01	7
PI 08-...	8
PI 09-01	9
PI 10-...	10

H 6 mm available in white. Other colours on demand.  
Available on demand in the colours 01-02-03-05-06-10-11-12-15-17-18-0106 (04-07-08-09-13-14-19-20-21-22-23-24-25-26-27-28-29 with a minimum quantity order of 800 pcs.  
The code of the selected colour must be added to the article code.  
E.g.: PI 06-... (chosen colour white) PI 06-01.

WHITE NOT FOR SALE SINGLY

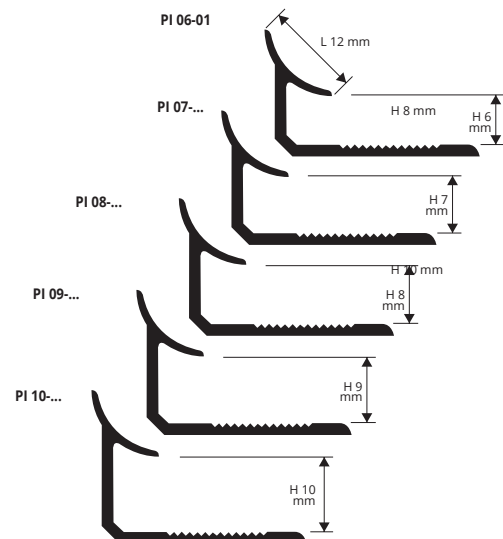

PI 07-... E PI 09-...  
**PRODUCTION ON DEMAND**  
**MINIMUM QUANTITY 800 PCS BY COLOUR AND HEIGHT**  
**(PRODUCTION DELAY 4/5 WEEKS)**

## COLOURS

01 - White	0106 - White ivory	02 - Light grey	03 - Cement gray
05 - Dark beige	06 - Ivory	10 - Red	11 - Black
12 - Silver	15 - Brown	17 - Bahama beige	18 - Grey

AVAILABLE MINIMUM QUANTITY 800 PCS by colour and height (Price to be agreed. Production delay 4/5 weeks)

04 - Light beige	07 - Pink	19 - Beige	20 - Dark ivory	21 - Light pink
08 - Sky blue	09 - Yellow	22 - Dark pink	23 - Dark antique pink	24 - Dark sky blue
13 - Gold	14 - Green	25 - Brick red	26 - Turquoise green	27 - Dark green
16 - Blue	28 - Hazel brown	29 - Dak brown		

## INTERNAL, EXTERNAL, THREE-WAYS PROINTER CORNER JOINTS

VARNISHED PLASTIC (Vinyl Resin) - pack. 10 Pcs

Article
REPI .../...
RIFI .../...
RITPI .../...

Available in the colours: 01-02-03-05-06-10-11-12-15-17-18-0106.  
Available on demand 04-07-08-09-13-14-19-20-21-22-23-24-25-26-27-28-29.  
The code of the selected colour must be added to the article code.  
E.g.: RIPI... (Chosen colour Ivory 06) RIPI 06.  
PLEASE CHOOSE THE DESIRED COLOUR CODE FROM OUR COLOUR CHART. SPECIFICATION OF THE HEIGHT IS NOT REQUIRED.

## COLOURS

01 - White	0106 - White ivory	02 - Light grey	03 - Cement gray	05 - Dark beige	06 - Ivory
10 - Red	11 - Black	12 - Silver	15 - Brown	17 - Bahama beige	18 - Grey

Corners of the on demand profiles are also on demand \*

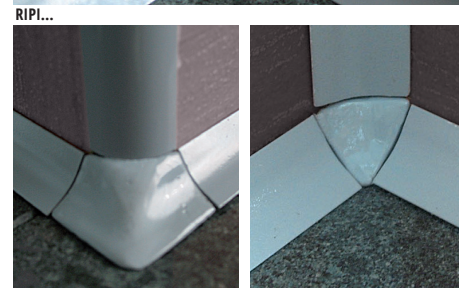

REPI...

RITPI...

\* = Production on demand with minimum quantity of 100 pcs. Production delay 4/5 weeks. Price to be agreed

# PROLISTEL CHANNEL

STAINLESS STEEL AISI 304/1.4301-V2A

**PROLISTEL CHANNEL** is a F-shaped strip in polished an satin-finish stainless steel AISI 304/1.4301-V2A suitable to decorate the wall coverings in ceramic tiles and natural stones. Its section allows the realization of a decorative joint which can also be used as a guide for the fixing of sheets of glass on floors and walls. Its particular section and the availability in two different finishes make **PROLISTEL CHANNEL** a much sought-after profile that allows an easy workmanlike application.

PLTCH... 08 - 10 - 11 - 12,5

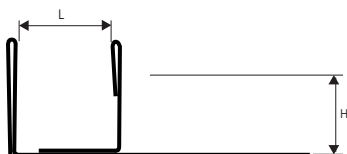

## EXAMPLES AND INSTRUCTIONS FOR LAYING METHODS

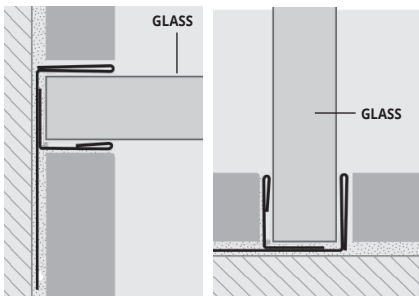

1. Choose "PROLISTEL CHANNEL" according to the visible surface and desired finish. 2. Cut "PROLISTEL CHANNEL" to the desired length and apply the adhesive on the surface where the profile will be laid. 3. Press "PROLISTEL CHANNEL" into the adhesive, aligning it with the tiles leaving a 2 mm. joint. Remove immediately all remains of adhesive from the surface of the profile. 4. Fill the joint between the profile and tiles with grout in order to avoid water stagnation. Remove immediately all the remains of grout from the surface of the profile.

## COLOURS



AC - Polished stainless steel AISI 304/1.4301-V2A  
ACS - Brushed stainless steel AISI 304/1.4301-V2A



**POLISHED STAINLESS STEEL AISI 304/1.4301-V2A**  
bar length 2,7 lm - pack. 1 Pc

Article	H mm	L mm
PLTCHAC 0812	8	12
PLTCHAC 1012	10	12
PLTCHAC 1112	11	12
PLTCHAC 12512	12,5	12



**SATIN-FINISH STAINLESS STEEL AISI 304/1.4301-V2A**  
bar length 2,7 lm - pack. 1 Pc

Article	H mm	L mm
PLTCHACS 0812	8	12
PLTCHACS 1012	10	12
PLTCHACS 1112	11	12
PLTCHACS 12512	12,5	12

**POLISHED STAINLESS STEEL AISI 304/1.4301-V2A**  
bar length 2,7 lm - pack. 1 Pc

Article	H mm	L mm
PLTCHAC 0808	8	08
PLTCHAC 1008	10	08
PLTCHAC 1108	11	08
PLTCHAC 12508	12,5	08

**SATIN-FINISH STAINLESS STEEL AISI 304/1.4301-V2A**  
bar length 2,7 lm - pack. 1 Pc

Article	H mm	L mm
PLTCHACS 0808	8	08
PLTCHACS 1008	10	08
PLTCHACS 1108	11	08
PLTCHACS 12508	12,5	08

**POLISHED STAINLESS STEEL AISI 304/1.4301-V2A**  
bar length 2,7 lm - pack. 1 Pc

Article	H mm	L mm
PLTCHAC 0810	8	10
PLTCHAC 1010	10	10
PLTCHAC 1110	11	10
PLTCHAC 12510	12,5	10

**SATIN-FINISH STAINLESS STEEL AISI 304/1.4301-V2A**  
bar length 2,7 lm - pack. 1 Pc

Article	H mm	L mm
PLTCHACS 0810	8	10
PLTCHACS 1010	10	10
PLTCHACS 1110	11	10
PLTCHACS 12510	12,5	10

# PROLISTEL CHANNEL

ANODIZED AND POLISHED ALUMINIUM

**PROLISTEL CHANNEL** is a F-shaped strip in anodized and polished aluminum suitable to decorate the wall coverings in ceramic tiles and natural stones. Its section allows the realization of a decorative joint which can also be used as a guide for the fixing of sheets of glass on floors and walls. Its particular section and the availability in two different finishes make **PROLISTEL CHANNEL** a much sought-after profile that allows an easy workmanlike application.

PLTCH... 08 - 10 - 11 - 12,5

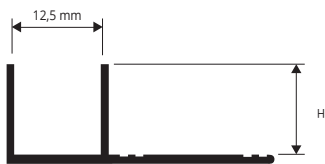

## EXAMPLES AND INSTRUCTIONS FOR LAYING METHODS

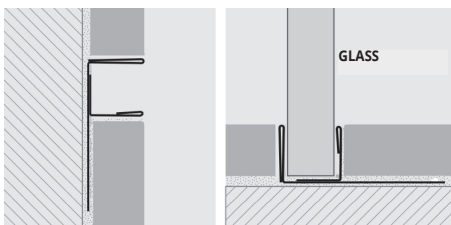

1. Scegliere "PROLISTEL CHANNEL" in funzione della superficie a vista e della finitura desiderata. 2. Tagliare "PROLISTEL CHANNEL" della lunghezza desiderata ed applicare l'adesivo sul supporto dove sarà applicato il listello. 3. Premere "PROLISTEL CHANNEL" nell'adesivo avendo cura di allinearne i bordi con la superficie del rivestimento e di lasciare una fuga di circa 2 mm. Rimuovere immediatamente residui di adesivo dalla superficie del profilo. 4. Stuccare accuratamente le fughe tra profilo e piastrella onde evitare il ristagno di eventuale acqua. Rimuovere immediatamente residui di stucco dalla superficie del profilo.



**ANODIZED SILVER ALUMINIUM**  
bar length 2,7 lm - pack. 40 Pcs - 108 lm

Article	H mm
PLTCHAA 08	8
PLTCHAA 10	10
PLTCHAA 11	11
PLTCHAA 125	12,5



**POLISHED CHROME ALUMINIUM**  
bar length 2,7 lm - pack. 40 Pcs - 108 lm

Article	H mm
PLTCHBC 08	8
PLTCHBC 10	10
PLTCHBC 11	11
PLTCHBC 125	12,5

## COLOURS

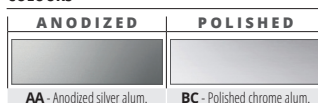

= News 2021

= Production on demand with minimum quantity of 100 pcs. Production delay 4/5 weeks. Price to be agreed

**PROTERMINAL INT** is a profile in anodized and polished aluminium that can be applied on external corners of coverings. It can be used to close the perimeter of coverings and like a connection profile between step tread and riser of stairs coated with ceramic or natural stone tiles. Its particular section and the availability in four different finishes make **PROTERMINAL INT** a much sought-after profile that allows an elegant workmanlike application.

# PROTERMINAL INT

ANODIZED AND POLISHED ALUMINIUM

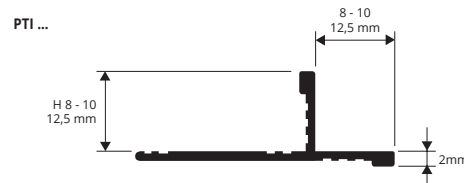

**ANODIZED ALUMINIUM** (silver - titanium) thermo packed  
bar length 2,7 lm - pack. 40 Pcs - 108 lm

Article	H mm		
PTIAA 08	8		
PTIAA 10	10		
PTIAA 125	12,5		
PTIAT 08	8		
PTIAT 10	10		
PTIAT 125	12,5		

**POLISHED ALUMINIUM** (chrome - titanium) thermo packed  
bar length 2,7 lm - pack. 40 Pcs - 108 lm

Article	H mm		
PTIBC 08	8		
PTIBC 10	10		
PTIBC 125	12,5		
PTIBT 08	8		
PTIBT 10	10		
PTIBT 125	12,5		

**INTERNAL, EXTERNAL, THREE-WAYS JOINTS**  
**ANODIZED POLISHED ALUMINIUM** - pack. 3 Pcs

Article		
RIPIT ... 08 - 10 - 125/3		
REPTI ... 08 - 10 - 125/3		
RTPIT ... 08 - 10 - 125/3		

**INTERNAL CORNER**  
RIPIT ... 08 - 10 - 125

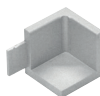

**EXTERNAL CORNER**  
REPTI ... 08 - 10 - 125



**3 WAYS JOINT**  
RTPIT ... 08 - 10 - 125



## EXAMPLES AND INSTRUCTIONS FOR LAYING METHODS

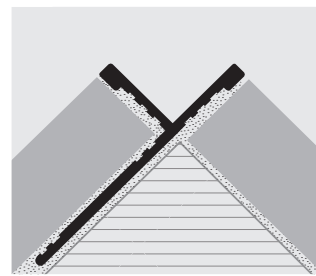

1. Choose "PROTERMINAL INT" according to the tile thickness and desired finish.
2. Cut "PROTERMINAL INT" to the desired length and apply the adhesive on the support where the profile will be laid.
3. Press the anchoring flange of "PROTERMINAL INT" into the adhesive.
4. Lay the tiles, aligning them with the profile leaving a 2 mm joint. Remove immediately all remains of adhesive from the surface of the profile.
5. Fill the joints between the profile and the tiles with grout, in order to avoid water stagnation. Remove immediately all the remains of grout from the surface of the profile.

## COLOURS

ANODIZED		POLISHED	
AA - Anodized silver alum.	AT - Anodized titanium alum.	BC - Polished chrome alum.	BT - Polished titanium alum.

On demand may be realised in other finishes of the colour chart. Contact our customer service for minimal quantity, timing and price.



# PROTERMINAL

POLISHED AND BRUSHED  
STAINLESS STEEL AISI 304/1.4301-V2A

**PROTERMINAL** is a L-shaped profile in polished and brushed stainless steel AISI 304/1.4301-V2A that can be applied on external tread and riser of stairs coated with ceramic and natural stone tiles, and also as separation profile for floor coverings. Its particular section and the availability in two different finishes make **PROTERMINAL** a much sought-after profile that allows a workmanlike application even in environments subject to high mechanical stresses.

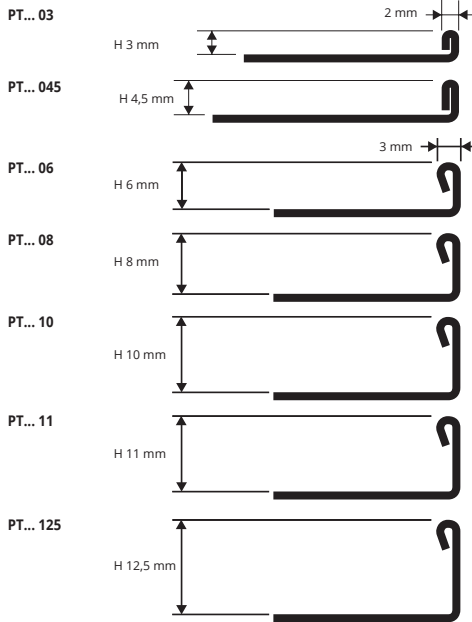

POLISHED STAINLESS ST. AISI 304/1.4301-V2A with protective film  
bar length 2,7 lm - pack. 40 Pcs - 108 lm - 10/10 mm

Article	H mm
PTAC 03	3
PTAC 045	4,5
PTAC 06	6
PTAC 08	8
PTAC 10	10
PTAC 11	11
PTAC 125	12,5

## EXAMPLES AND INSTRUCTIONS FOR LAYING METHODS

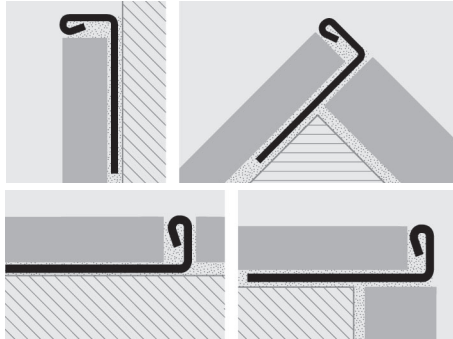

1. Choose "PROTERMINAL" according to the tile thickness and desired finish.
2. Cut "PROTERMINAL" to the desired length and apply the adhesive on the support where the profile will be laid.
3. Press the anchoring flange of "PROTERMINAL" into the adhesive.
4. Lay the tiles, aligning them with the profile leaving a 2 mm joint. Remove immediately all remains of adhesive from the surface of the profile.
5. Fill the joints between the profile and the tiles with grout, in order to avoid water stagnation. Remove immediately all the remains of grout from the surface of the profile.

BRUSHED STAINLESS STEEL AISI 304/1.4301-V2A with protective film  
bar length 2,7 lm - pack. 40 Pcs - 108 lm - 10/10 mm

Article	H mm
PTACS 03	3
PTACS 045	4,5
PTACS 06	6
PTACS 08	8
PTACS 10	10
PTACS 11	11
PTACS 125	12,5

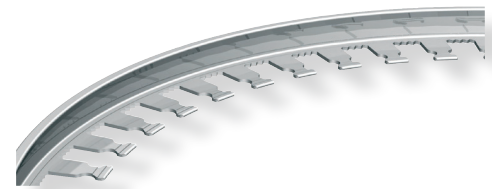

Curve version available

## COLOURS



SUITABLE FOR USE IN CONTACT WITH FOODSTUFFS.

# PROTERMINAL

POLISHED STAINLESS STEEL  
AISI 316L/1.4404-V4A

**PROTERMINAL** is a L-shaped profile in polished stainless steel AISI 304/1.4301-V2A that can be applied on external tread and riser of coverings. It can be used to close the perimeter of coverings, like a connection profile between step tread and riser of stairs coated with ceramic and natural stone tiles and also as separation profile for floor and wall coverings. Its particular section and the availability in two different finishes make **PROTERMINAL** a much sought-after profile that allows a workmanlike application even in environments subject to high mechanical and chemical stresses.

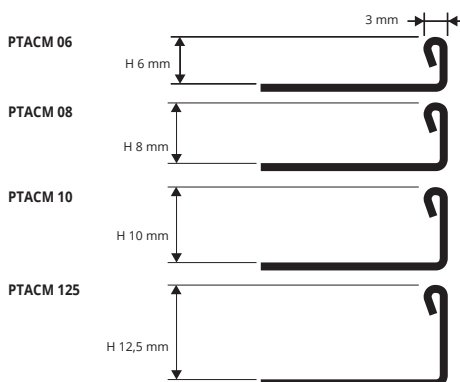

POLISHED STAINLESS ST. AISI 316/1.4404-V4A  
with protective film  
bar length 2,7 lm - pack. 40 Pcs - 108 lm - 10/10 mm



Article	H mm
PTACM 06	6
PTACM 08	8
PTACM 10	10
PTACM 125	12,5

## COLOURS

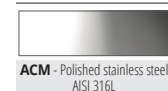

ACM - Polished stainless steel  
AISI 316L

1. Choose "PROTERMINAL" according to the tile thickness.
2. Cut "PROTERMINAL" to the desired length and apply the adhesive on the support where the profile will be laid.
3. Press the anchoring flange of "PROTERMINAL" into the adhesive.
4. Lay the tiles, aligning them with the profile leaving a 2 mm joint. Remove immediately all remains of adhesive from the surface of the profile.
5. Fill the joints between the profile and the tiles with grout, in order to avoid water stagnation. Remove immediately all the remains of grout from the surface of the profile.

SUITABLE FOR USE IN CONTACT WITH FOODSTUFFS.

\* = Production on demand with minimum quantity of 100 pcs. Production delay 4/5 weeks. Price to be agreed



**PROTERMINAL** is a L-shaped profile in chromed and antique brass that can be applied on external corners of coverings. It can be used to close the perimeter of coverings, like a connection profile between step tread and riser of stairs coated with ceramic or natural stone tiles and also as separation profile for floor and wall coverings. Its particular section and elegance make PROJOLLY a much sought-after profile that allows a workmanlike application.

# PROTERMINAL

CHROMED BRASS, BRUSHED BRASS AND ANTIQUE BRASS



**CHROMED BRASS thermo packed**  
bar length 2,7 lm - pack. 20 Pcs - 54 lm

Article	H mm
PTOC 06	6
PTOC 08	8
PTOC 10	10
PTOC 125	12,5

## COLOURS

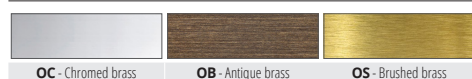

**BRUSHED BRASS thermo packed**  
bar length 2,7 lm - pack. 20 Pcs - 54 lm

Article	H mm
PTOS 06	6
PTOS 08	8
PTOS 10	10
PTOS 125	12,5

**ANTIQUÉ BRASS thermo packed**  
bar length 2,7 lm - pack. 20 Pcs - 54 lm

Article	H mm
PTOB 06	6
PTOB 08	8
PTOB 10	10
PTOB 125	12,5

## INSTRUCTIONS FOR LAYING METHODS

1. Choose "PROTERMINAL" according to the tile thickness. 2. Cut "PROTERMINAL" to the desired length and apply the adhesive on the support where the profile will be laid. 3. Press the anchoring flange of "PROTERMINAL" into the adhesive. 4. Lay the tiles, aligning them with the profile leaving a 2 mm joint. Remove immediately all remains of adhesive from the surface of the profile. 5. Fill the joints between the profile and the tiles with grout, in order to avoid water stagnation. Remove immediately all the remains of grout from the surface of the profile.

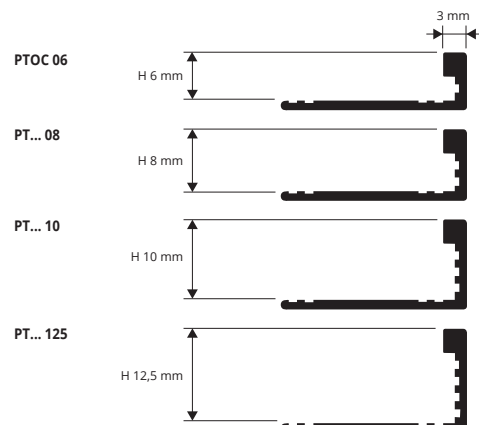

## EXEMPLES OF LAYING

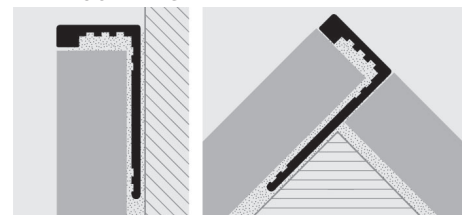

**PROTERMINAL** is a L-shaped profile in natural and anodized aluminium that can be applied on external corners of coverings. It can be used to close the perimeter of coverings, like a connection profile between step tread and riser of stairs coated with ceramic or natural stone tiles and also as separation profile for floor and wall coverings. Its particular section and the availability in six different finishes make **PROTERMINAL** a much sought-after profile that allows a workmanlike application.

# PROTERMINAL

NATURAL AND ANODIZED ALUMINIUM



**ANODIZED ALUMINIUM (gold - silver) thermo packed**  
bar length 2,7 lm - pack. 40 Pcs - 108 lm

Article	H mm
PTAA 03	3
PTAA 045	4,5
PTAA 06	6
PTAA 08	8
PTAA 10	10
PTAA 11	11
PTAA 125	12,5
PTAA 15	15
PTAA 20	20
PTAO 03	3
PTAO 045	4,5
PTAO 06	6
PTAO 08	8
PTAO 10	10
PTAO 11	11
PTAO 125	12,5

## COLOURS



**ANODIZED ALUMINIUM (black-titanium-copper-bronze- antique bronze) thermo packed** - bar length 2,7 lm - pack. 40 Pcs - 108 lm

Article	H mm
PTNE 08	8
PTNE 10	10
PTNE 125	12,5
PTAT 08	8
PTAT 10	10
PTAT 11	11
PTAT 125	12,5
PTAR 08	8
PTAR 10	10
PTAR 125	12,5
PTAB 08	8
PTAB 10	10
PTAB 125	12,5
PTBRA 10	10
PTBRA 125	12,5

## NATURAL ALUMINIUM

bar length 2,7 lm - pack. 40 Pcs - 108 lm

Article	H mm
PTAN 03	3
PTAN 045	4,5

## COLOURS



On demand may be realised in other finishes of the colour chart. Contact our customer service for minimal quantity, timing and price.

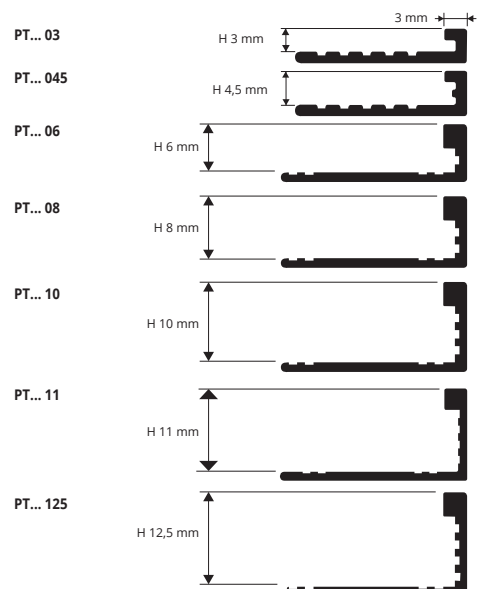

## EXEMPLES AND INSTRUCTIONS FOR LAYING METHODS

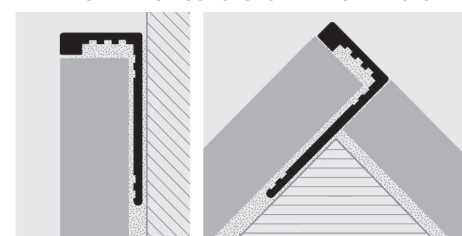

1. Choose "PROTERMINAL" according to the tile thickness and desired finish. 2. Cut "PROTERMINAL" to the desired length and apply the adhesive on the support where the profile will be laid. 3. Press the anchoring flange of "PROTERMINAL" into the adhesive. 4. Lay the tiles, aligning them with the profile leaving a 2 mm joint. Remove immediately all remains of adhesive from the surface of the profile. 5. Fill the joints between the profile and the tiles with grout, in order to avoid water stagnation. Remove immediately all the remains of grout from the surface of the profile.

# PROTERMINAL

POLISHED, BRUSHED AND VARNISHED ALUMINIUM

**PROTERMINAL** is a L-shaped profile in polished, brushed and varnished aluminium that can be applied on external corners of coverings. It can be used to close the perimeter of coverings, like a connection profile between step tread and riser of stairs coated with ceramic or natural stone tiles and also as separation profile for floor and wall coverings (the varnished only for wall application). Its particular section and the availability in different finishes make **PROTERMINAL** a much sought-after profile that allows a workmanlike application.

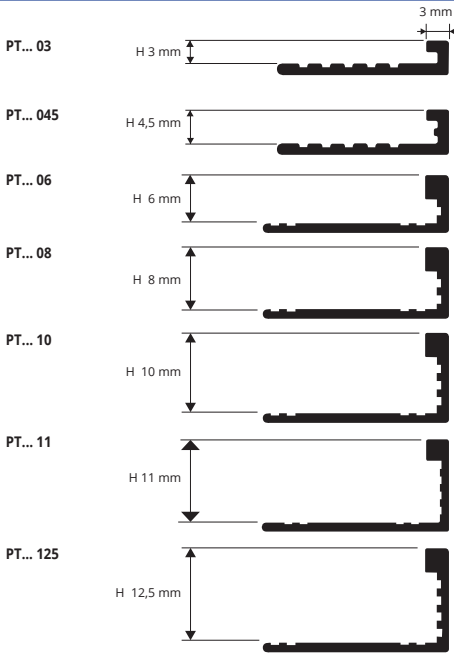

## EXAMPLES AND INSTRUCTIONS FOR LAYING METHODS

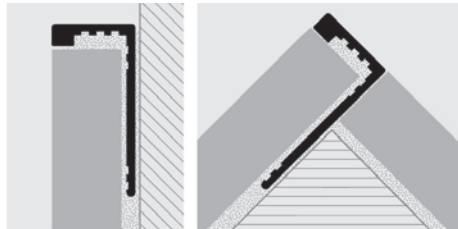

1. Choose "PROTERMINAL" according to the tile thickness and desired finish (color).
2. Cut "PROTERMINAL" to the desired length and apply the adhesive on the support where the profile will be laid.
3. Press the anchoring flange of "PROTERMINAL" into the adhesive.
4. Lay the tiles, aligning them with the profile leaving a 2 mm joint. Remove immediately all remains of adhesive from the surface of the profile.
5. Fill the joints between the profile and the tiles with grout, in order to avoid water stagnation. Remove immediately all the remains of grout from the surface of the profile.



**POLISHED ALUMINIUM** (chrome, gold, copper, titanium, black)  
thermo packed - bar length 2,7 lm - pack. 40 Pcs - 108 lm

Article	H mm		
PTBC 03	3		
PTBC 045	4,5		
PTBC 06	6		
PTBC 08	8		
PTBC 10	10		
PTBC 11	11		
PTBC 125	12,5		
PTBO 03	3		
PTBO 045	4,5		
PTBO 06	6		
PTBO 08	8		
PTBO 10	10		
PTBO 11	11		
PTBO 125	12,5		
PTBT 08	8		
PTBT 10	10		
PTBT 11	11		
PTBT 125	12,5		
PTBR 08	8		
PTBR 10	10		
PTBR 125	12,5		
PTBN 06	6		
PTBN 08	8		
PTBN 10	10		
PTBN 125	12,5		



**BRUSHED ALUMINIUM** (silver, titanium, black, copper, antique bronze)  
thermo packed - bar length 2,7 lm - pack. 40 Pcs - 108 lm

Article	H mm		
PTBS 045	4,5		
PTBS 08	8		
PTBS 10	10		
PTBS 11	11		
PTBS 125	12,5		
PTRS 045	4,5		
PTRS 08	8		
PTRS 10	10		
PTRS 125	12,5		
PTTS 045	4,5		
PTTS 08	8		
PTTS 10	10		
PTTS 11	11		
PTTS 125	12,5		
PTBOS 08	8		
PTBOS 10	10		
PTBOS 125	12,5		
PTNS 08	8		
PTNS 10	10		
PTNS 125	12,5		
PTBRAS 10	10		
PTBRAS 125	12,5		

## COATED ALUMINIUM thermo packed

bar length 2,7 lm - pack. 20 Pcs - 54 lm (colour white 40 Pcs - 108 lm)

Article	H mm		
PTA 06-01	6		
PTA 08-01	8		
PTA 10-...	10		
PTA 11-01	11		
PTA 125-01	12,5		

H 10 available in the colours: 01 - 0106 - 11.

The code of the selected colour must be added to the article code.  
E.g.: PTA 10-... (chosen colour white ivory varnished alum.)

PTA 10-0106.

## COLOURS

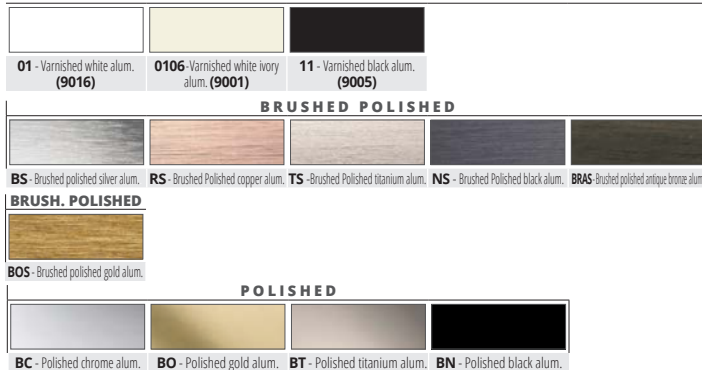

## AVAILABLE MINIMUM QUANTITY 100 PCS by colour and height (Price to be agreed. Production delay 4/5 weeks)

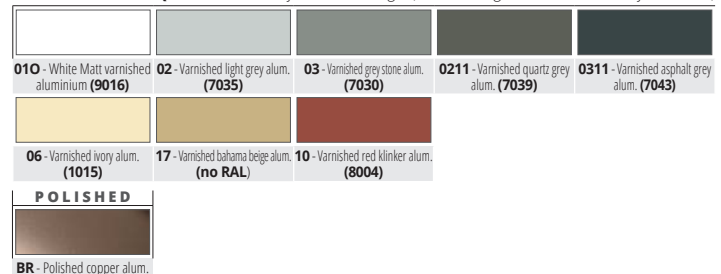

PTA 06-... & PTA 125-... For other colours different from white, please contact our company for quantity and price. Production on demand, production delay 4/5 weeks. (minimum quantity order of 100 pcs).

\* = Production on demand with minimum quantity of 100 pcs. Production delay 4/5 weeks. Price to be agreed

**PROTERMINAL** is a L-shaper profile in powder coated aluminum that can be applied on external corners of coverings. It can be used to close the perimeter of coverings. Its particular section and the availability in different finishes make **PROTERMINAL** an elegant and much-sought after profile.

# PROTERMINAL

STONE LINE ALUMINIUM AND TUSCANY LINE



**STONE LINE thermo packed**  
bar length 2,7 lm - pack. 20 Pcs - 54 lm

Article	H mm		
PTA 06-SL...	6		
PTA 08-SL...	8		
PTA 10-SL...	10		
PTA 11-SL...	11		
PTA 125-SL...	12,5		

The code of the selected colour must be added to the article code.  
E.g.: PTA 08... (chosen colour Stone white) PTA 08-SL01.

**TUSCANY LINE thermo packed**  
bar length 2,7 lm - pack. 40 Pcs - 108 lm

Article	H mm		
PTA 08-...	8		
PTA 10-...	10		
PTA 125-...	12,5		

The code of the selected colour must be added to the article code.  
E.g.: PTA 08-... (chosen colour tuscanly grey) PTA 08-03TU.

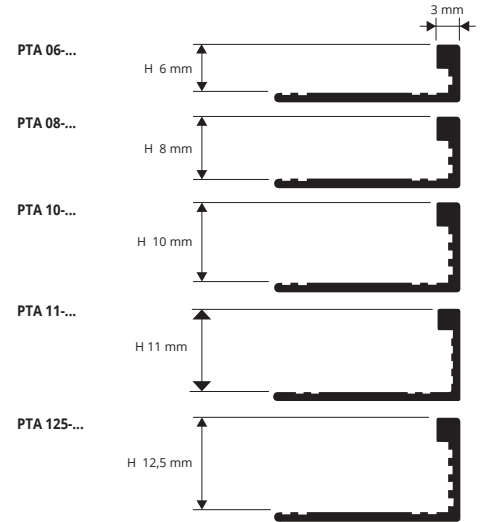

## COLOURS

STONE LINE						
SL01 - Stone white	SL02 - Stone cream	SL03 - Stone greyvory	SL04 - Stone sand	SL05 - Stone gray	SL06 - Stone cristal gray	SL07 - Stone antragray
SL08 - Stone antradark	SL09 - Stone bronze	SL10 - Stone corten	SL11 - Stone brown	SL12 - Stone black	SL13 - Stone oyster grey	
TUSCANY						
03TU - Tuscanly grey	05TU - Tuscanly beige	20TU - Tuscanly bronze				

## EXAMPLES FOR LAYING METHODS

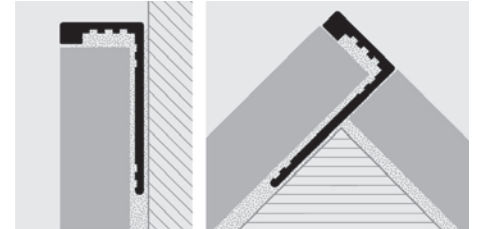

**PROTERMINAL** is a L-shaped profile in shockproof non - toxic colored vinyl resin that can be applied on external corners of coverings. It can be used to close the perimeter of coverings. Its particular section and the availability in different colours also on demand make **PROTERMINAL** a much sought-after profile. It can be easily matched with the wall covering and allows an elegant workmanlike application.

# PROTERMINAL

SHOCKPROOF NON - TOXIC COLOURED VINYL RESIN

**NON-TOXIC SHOCKPROOF COLOURED VINYL RESIN**  
bar length 2,7 lm - pack. 54 lm (white 108 lm)

Article	H mm		
PT 06-...	6		
PT 08-...	8		
PT 10-...	10		
PT 125-...	12,5		

Available in the colours: 01-0106-02-03-04-05-06-11-12-17-18  
Available on demand 19-20-21-22-23-24-25-26-27-28-29-07-08-09-10-13-14-15-16 with a minimum quantity order of 800 pcs. The code of the selected colour must be added to the article code. E.g.: PT 06-... (chosen colour white) PT 06-01.

WHITE NOT FOR SALE SINGLY



## EXAMPLE AND INSTRUCTIONS FOR LAYING METHODS

1. Choose "PROTERMINAL" according to the tile thickness and desired colour. 2. Cut "PROTERMINAL" to the desired length and apply the adhesive on the support where the profile will be laid. 3. Press the anchoring flange of "PROTERMINAL" into the adhesive. 4. Lay the tiles, aligning them with the profile leaving a 2 mm joint. 5. Fill the joints between the profile and the tiles with grout, in order to avoid water stagnation.

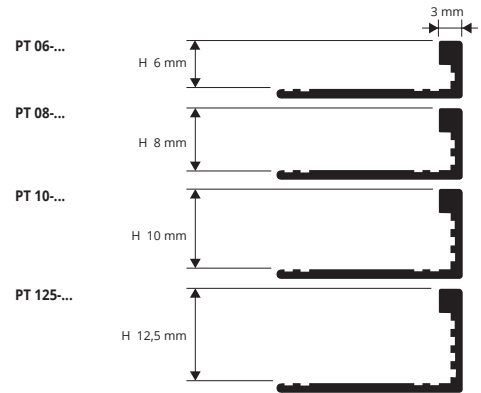

## COLOURS

01 - White	0106 - White ivory	02 - Light grey	03 - Cement gray
04 - Light Beige	05 - Dark Beige	06 - Ivory	11 - Black
12 - Silver	17 - Bahama Beige	18 - Grey	

AVAILABLE MINIMUM QUANTITY 800 PCS by colour and height (Price to be agreed. Production delay 4/5 weeks)

19 - Beige	20 - Dark ivory	21 - Light pink	22 - Dark pink	23 - Dark antique pink
24 - Dark sky blue	25 - Brick red	26 - Turquoise green	27 - Dark green	28 - Hazel brown
29 - Dak brown	07 - Pink	08 - Sky blue	09 - Yellow	10 - Red
13 - Gold	14 - Green	15 - Brown	16 - Blue	

# PROLISTEL ACC

POLISHED, BRUSHED, SANDED  
STAINLESS STEEL AISI 304/1.4301-V2A

**PROLISTEL ACC** is a listel in polished, brushed, sanded stainless steel AISI 304/1.4301-V2A with a flat and U-shaped (internal use) visible surface, suitable to decorate the wall coverings in ceramic, mosaic and natural stone. Its particular section and availability in different finishes, make **PROLISTEL ACC** a much sought after profile. It can be used with the range of PROJOLLY profiles to decorate the wall coverings and to allow an elegant workmanlike application.

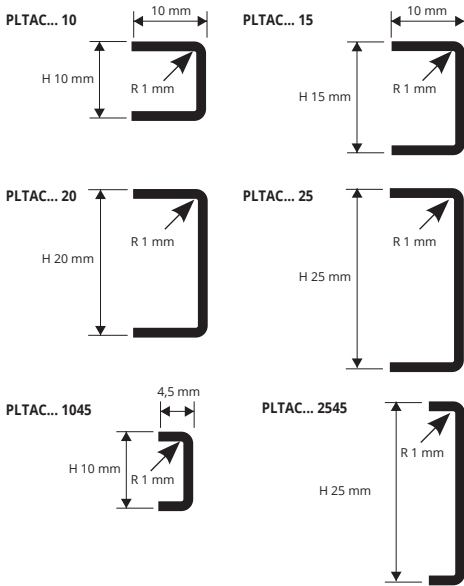

## EXAMPLES AND INSTRUCTIONS FOR LAYING METHODS

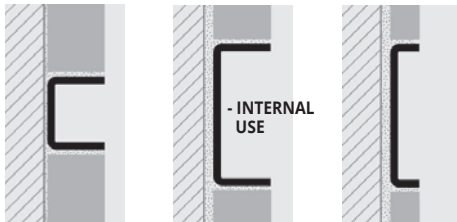
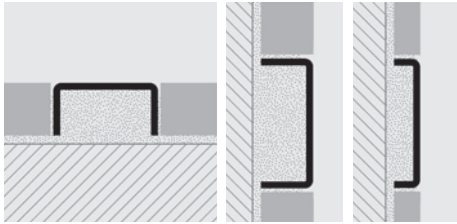

1. Choose "PROLISTEL ACC" according to the width and desired finish. 2. Cut "PROLISTEL ACC" to the desired length and apply the adhesive on the support where the profile will be laid. 3. Press "PROLISTEL ACC" into the adhesive. 4. Lay the tiles, aligning them with the profile leaving a 2 mm joint. Remove immediately all remains of adhesive from the surface of the profile. 5. Fill the joints between the profile and the tiles with grout, in order to avoid water stagnation. Remove immediately all the remains of grout from the surface of the profile.

**POLISHED STAINLESS ST. AISI 304/1.4301-V2A with protective film**  
bar length 2,7 lm - pack. 40 Pcs - 108 lm - 8/10mm

Article	HxL mm		
PLTAC 10	10 x 10		
PLTAC 1045	10 x 4,5		
PLTAC 15	15 x 10		
PLTAC 20	20 x 10		
PLTAC 25	25 x 10		
PLTAC 2545	25 x 4,5		

**POLISHED STAINLESS STEEL AISI 304/1.4301-V2A - INTERNAL USE**  
with protective film - bar length 2,7 lm  
pack. 40 Pcs 108 lm - 8/10mm

Article	HxL mm		
PLTACI 10	10 x 10		
PLTACI 1045	10 x 4,5		
PLTACI 15	15 x 10		
PLTACI 20	20 x 10		
PLTACI 25	25 x 10		
PLTACI 2545	25 x 4,5		

**Brushed STAINLESS ST. AISI 304/1.4301-V2A with protective film**  
bar length 2,7 lm - pack. 40 Pcs - 108 lm - 8/10mm

Article	HxL mm		
PLTACS 10	10 x 10		
PLTACS 1045	10 x 4,5		
PLTACS 15	15 x 10		
PLTACS 20	20 x 10		
PLTACS 25	25 x 10		
PLTACS 2545	25 x 4,5		

**Brushed STAINLESS STEEL AISI 304/1.4301-V2A - INTERNAL USE**  
with protective film - bar length 2,7 lm pack. 40 Pcs 108 lm - 8/10mm

Article	HxL mm		
PLTACSI 10	10 x 10		
PLTACSI 1045	10 x 4,5		
PLTACSI 15	15 x 10		
PLTACSI 20	20 x 10		
PLTACSI 25	25 x 10		
PLTACSI 2545	25 x 4,5		

**SANDED STAINLESS ST. AISI 304/1.4301-V2A with protective film**  
bar length 2,7 lm - pack. 40 Pcs 108 lm - 8/10mm

Article	HxL mm		
PLTACSB 10	10 x 10		

SUITABLE FOR USE IN CONTACT WITH FOODSTUFFS.



\* = Production on demand with minimum quantity of 100 pcs. Production delay 4/5 weeks. Price to be agreed

**PROLISTEL ACC** is a range of decorative profiles/strips that are ideal for easily creating chromatic effects on ceramic tile/marble/mosaic coverings or, in the stainless steel AISI 316LL/1.4301-V4A range, for creating separations and decorations between floors in the same or differing material. Thanks to their design, shape and thickness of 4,5 and 10 mm, may be laid using the same adhesive to create horizontal and vertical lines, on the wall or on the floor, irrespective of the thickness of the covering. Various widths available in stainless steel AISI 04/1.4301-V2A, polished. Match with the same basic colours in the PROJOLLY, PROTERMINAL and PROJOLLY SQUARE and the new PROKERLAM SQUARE-LINE-JOLLY range.

# PROLISTEL ACC

POLISHED STAINLESS STEEL  
AISI 316L/1.4404 - V4A



**POLISHED STAINLESS STEEL AISI 316LL/1.4404-V4A**  
with protective film - bar length 2,7 lm  
pack. 40 Pcs - 108 lm - 8/10mm



Article	HxL mm		
PLTACM 10	10 X 10		
PLTACM 1045	10 X 4,5		
PLTACM 15	15 X 10		
PLTACM 20	20 X 10		
PLTACM 25	25 X 10		
PLTACM 2545	25 X 4,5		

**POLISHED STAINLESS STEEL AISI 316LL/1.4404-V4A -**  
**INTERNAL USE** with protective film - bar length 2,7 lm  
pack. 40 Pcs - 108 lm - 8/10mm



Article	HxL mm		
PLTACMI 10	10 X 10		
PLTACMI 1045	10 X 4,5		
PLTACMI 15	15 X 10		
PLTACMI 20	20 X 10		
PLTACMI 25	25 X 10		
PLTACMI 2545	25 X 4,5		

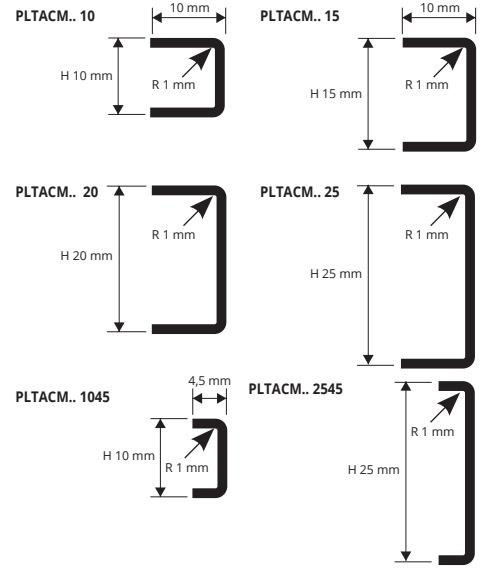

## EXAMPLES AND INSTRUCTIONS FOR LAYING METHODS

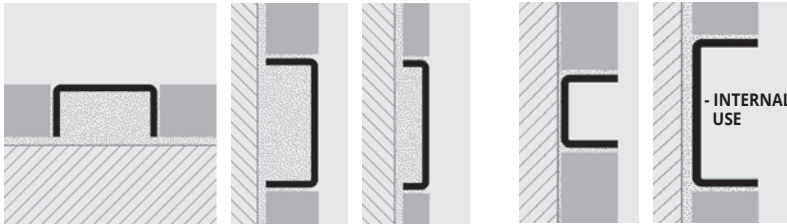

1. Choose the PROLISTEL ACC in the required width. 2. Apply the adhesive onto the area of application of the profile. 3. Lay and align the profile, cut to the necessary length, pressing it into the adhesive. 4. Lay the tiles, aligning them so that the top edge of the profile is flush with the tile. 5. Fill the profile/tile area of contact with adhesive to prevent the accumulation of water in any voids. Pay attention to the external edges of the PROLISTEL ACC. They must be protected against agents such as adhesives and sealants and against grinding or scraping actions.

SUITABLE FOR USE IN CONTACT WITH FOODSTUFFS.

## COLOURS



**PROLISTEL P OTT** is a decorative listel in polished, chromed and antique brass with a flat visible surface. The profile is suitable to decorate the wall coverings in ceramic, mosaic and natural stone. Its particular section and availability in different finishes and two widths, make **PROLISTEL P OTT** a much sought after profile. It could be matched with PROJOLLY, PROJOLLY SQUARE e PROTERMINAL profiles to decorate the wall coverings and to allow an elegant workmanlike application.

# PROLISTEL P OTT

POLISHED, CHROMED,  
ANTIQUÉ BRASS



**POLISHED, CHROMED AND ANTIQUE BRASS thermo packed** - Bar  
length 2,7 lm - pack 40 PCS - 108 lm

Article	H mm		
PLTPOL 25	25		
PLTPOC 25	25		*
PLTPOB 25	25		*

## COLOURS

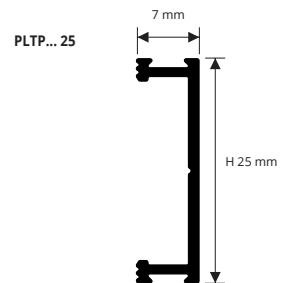

## EXAMPLES AND INSTRUCTIONS FOR LAYING



1. Choose "PROLISTEL P OTT" according to the width and desired finish. 2. Cut "PROLISTEL P OTT" to the desired length and apply the adhesive on the support where the profile will be laid. 3. Press "PROLISTEL P OTT" into the adhesive. 4. Lay the tiles, aligning them with the profile leaving a 2 mm joint. Remove immediately all remains of adhesive from the surface of the profile. 5. Fill the joints between the profile and the tiles with grout, in order to avoid water stagnation. Remove immediately all the remains of grout from the surface of the profile.

# PROLISTEL P ALL

ANODIZED, POLISHED, STONE LINE, BRUSHED, TUSCANY AND TILTEX ALUMINIUM

**PROLISTEL P ALL** is a decorative listel in anodized, polished, brushed, tiltex aluminium and varnished tuscanly and stone aluminium with a flat visible surface. The profile is suitable to decorate the wall coverings in ceramic, mosaik and natural stone. Its particular section and availability in different finishes and two widths, make **PROLISTEL P ALL** a much sought after profile. It could be matched with PROJOLLY, PROJOLLY SQUARE e PROTERMINAL profiles to decorate the wall coverings and to allow an elegant workmanlike application.

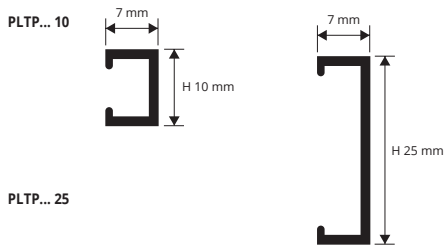

## EXAMPLES AND INSTRUCTIONS FOR LAYING METHODS

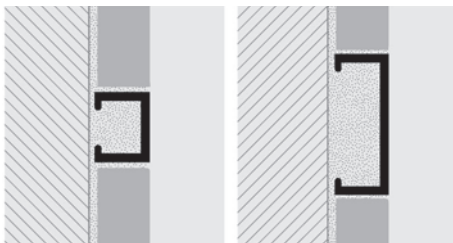

1. Choose "PROLISTEL P ALL" according to the width and desired finish. 2. Cut "PROLISTEL P ALL" to the desired length and apply the adhesive on the support where the profile will be laid. 3. Press "PROLISTEL P ALL" into the adhesive. 4. Lay the tiles, aligning them with the profile leaving a 2 mm joint. Remove immediately all remains of adhesive from the surface of the profile. 5. Fill the joints between the profile and the tiles with grout, in order to avoid water stagnation. Remove immediately all the remains of grout from the surface of the profile.

## ALUMINIUM TUSCANY LINE

thermo packed - bar length 2,7 lm - pack. 40 Pcs - 108 lm

Article	H mm
PLTPA 10-...TU	10
PLTPA 25-...TU	25

## STONE LINE ALUMINIUM

thermo packed - bar length 2,7 lm - pack. 40 Pcs - 108 lm

Article	H mm
PLTPA 10-SL01	10
PLTPA 10-SL08	10
PLTPA 10-SL12	10
PLTPA 10-...	10
PLTPA 25-SL01	25
PLTPA 25-SL08	25
PLTPA 25-SL12	25
PLTPA 25-...	25

## ANODIZED ALUMINIUM

thermo packed - bar length 2,7 lm - pack. 40 Pcs - 108 lm

Article	H mm
PLTPAA 10	10
PLTPAO 10	10
PLTPAR 10	10
PLTPAT 10	10
PLTPNE 10	10
PLTPAA 25	25
PLTPAO 25	25
PLTPAR 25	25
PLTPAT 25	25
PLTPNE 25	25

## POLISHED ALUMINIUM

thermo packed - bar length 2,7 lm - pack. 40 Pcs - 108 lm

Article	H mm
PLTPBC 10	10
PLTPBO 10	10
PLTPBR 10	10
PLTPBT 10	10
PLTPBN 10	10
PLTPBC 25	25
PLTPBO 25	25
PLTPBR 25	25
PLTPBT 25	25
PLTPBN 25	25

## POLISHED BRUSHED ALUMINIUM

thermo packed - bar length 2,7 lm - pack. 40 Pcs - 108 lm

Article	H mm
PLTPBS 10	10
PLTPBOS 10	10
PLTPRS 10	10
PLTPTS 10	10
PLTPNS 10	10
PLTPBS 25	25
PLTPBOS 25	25
PLTPRS 25	25
PLTPTS 25	25
PLTPNS 25	25

## ANODIZED BRUSHED ALUMINIUM TILTEX

thermo packed - bar length 2,7 lm - pack. 40 Pcs - 108 lm

Article	H mm
PLTPBX 10	10
PLTPRX 10	10
PLTPTX 10	10
PLTPBX 25	25
PLTPRX 25	25
PLTPTX 25	25

## COLOURS

ANODIZED				POLISHED				BLACK LINE					
AA - Anodized silver aluminium	AR - Anodized copper aluminium	AT - Anodized titanium aluminium	AO - Anodized gold aluminium	BC - Polished chrome aluminium	BO - Polished gold aluminium	BR - Polished bronze aluminium	BT - Polished titanium aluminium	BN - Polished black aluminium	NE - Anodized black aluminium	NS - Polished brushed black aluminium	ON DEMAND	ON DEMAND	ON DEMAND
POLISHED BRUSHED				BRUSHED TILTEX				TUSCANY					
BS - Polished brushed aluminium	BOS - Polished brushed gold aluminium	TS - Polished brushed titanium aluminium	RS - Polished brushed copper aluminium	BX - Tiltex silver aluminium	TX - Tiltex titanium aluminium	RX - Tiltex copper aluminium	ON DEMAND	ON DEMAND	ON DEMAND	ON DEMAND	ON DEMAND	ON DEMAND	ON DEMAND
SL01 - Stone white	SL08 - Antradark	SL12 - Stone black					03TU - Tuscanly grey	05TU - Tuscanly Beige	20TU - Tuscanly Bronze				

AVAILABLE MINIMUM QUANTITY 100 PCS by colour and height (Price to be agreed. Production delay 4/5 weeks) **STONE LINE**

SL02 - Stone cream	SL03 - Stone greyvory	SL04 - Stone sand	SL05 - Stone gray	SL06 - Stone cristal gray	SL07 - Stone antragray	SL09 - Stone bronze	SL10 - Stone corten	SL11 - Stone brown	SL13 - Stone oyster grey
--------------------	-----------------------	-------------------	-------------------	---------------------------	------------------------	---------------------	---------------------	--------------------	--------------------------

\* = Production on demand with minimum quantity of 100 pcs. Production delay 4/5 weeks. Price to be agreed

\*\* = Production on demand with minimum quantity of 80 pcs. Production delay 4/5 weeks. Price to be agreed

**PROLISTEL ALL** is a listel in anodized, polished and brushed aluminium with a rounded visible surface, suitable to decorate the wall coverings in ceramic, mosaic and natural stone. Its particular section and availability in different finishes, make **PROLISTEL P ALL** a much sought after profile. It can be used with the range of PROJOLLY profiles to decorate the wall coverings and to allow an elegant workmanlike application.

# PROLISTEL ALL

ANODIZED, POLISHED AND BRUSHED ALUMINIUM



**ANODIZED ALUMINIUM** (silver-gold-copper-titanium-black)  
thermo packed - bar length 2,7 lm - pack. 40 Pcs - 108 lm

Article	H mm		
PLTAA 15	15		
PLTAR 15	15		
PLTAT 15	15		
PLTAO 15	15		
PLTNE 15	15		
PLTAA 25	25		
PLTAR 25	25		
PLTAT 25	25		
PLTAO 25	25		
PLTNE 25	25		

**BRUSHED POLISHED ALUMINIUM** (silver-gold-copper-titanium-black)  
thermo packed - bar length 2,7 lm - pack. 40 Pcs - 108 lm

Article	H mm		
PLTBS 15	15		
PLTRS 15	15		
PLTTS 15	15		
PLTBOS 15	15		
PLTNS 15	15		
PLTBS 25	25		
PLTRS 25	25		
PLTTS 25	25		
PLTBOS 25	25		
PLTNS 25	25		

**POLISHED ALUMINIUM** (chrome-gold-copper-titanium-black)  
thermo packed - bar length 2,7 lm - pack. 40 Pcs - 108 lm

Article	H mm		
PLTBC 15	15		
PLTBR 15	15		
PLTBT 15	15		
PLTBO 15	15		
PLTBN 15	15		
PLTBC 25	25		
PLTBR 25	25		
PLTBT 25	25		
PLTBO 25	25		
PLTBN 25	25		

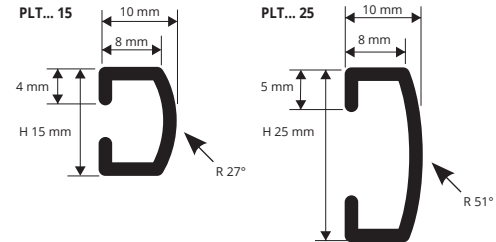

### EXAMPLES AND INSTRUCTIONS FOR LAYING METHODS



1. Choose "PROLISTEL ALL" according to the width and desired finish.
2. Cut "PROLISTEL ALL" to the desired length and apply the adhesive on the support where the profile will be laid.
3. Press "PROLISTEL ALL" into the adhesive.
4. Lay the tiles, aligning them with the profile leaving a 2 mm joint. Remove immediately all remains of adhesive from the surface of the profile.
5. Fill the joints between the profile and the tiles with grout, in order to avoid water stagnation. Remove immediately all the remains of grout from the surface of the profile.

### COLOURS

ANODIZED			POLISHED		BRUSHED POLISHED	
AA - Anodized silver alum.	AT - Anodized titanium alum.	NE - Anodized black alum.	BC - Polished chrome alum.	BT - Polished titanium alum.	BS - Brushed polished silver alum.	TS - Brushed Polished titanium alum.

AVAILABLE MINIMUM QUANTITY 100 PCS by colour and height (Price to be agreed. Production delay 4/5 weeks)

ANODIZED			POLISHED			BRUSHED POLISHED		
AO - Anodized Gold alum.	AR - Anodized copper alum.	BO - Polished Gold alum.	BR - Polished copper alum.	BN - Polished black alum.	BOS - Brushed Gold alum.	RS - Brushed Polished copper alum.	NS - Brushed Polished black alum.	

On demand may be realised in other finishes of the colour chart. Contact our customer service for minimal quantity, timing and price.

**PROLISTEL LED** is a listel in anodized and polished aluminium equipped with an integrated LED lighting system that can generate a cold, hot and neutral suffused light. It is suitable to decorate the wall coverings in ceramic, mosaic and natural stone. Its particular section and availability in different finishes, make **PROLISTEL LED** a much sought after profile that decorates the wall coverings.

# PROLISTEL LED

ANODIZED AND POLISHED ALUMINIUM

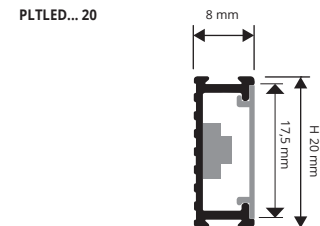

### EXAMPLES AND INSTRUCTIONS FOR LAYING METHODS

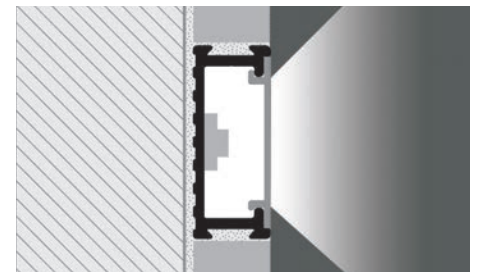

1. Choose "PROLISTEL LED" according to the width and desired finish.
2. Cut "PROLISTEL LED" to the desired length and apply the adhesive on the support where the profile will be laid.
3. Press "PROLISTEL LED" into the adhesive.
4. Lay the tiles, aligning them with the profile leaving a 2 mm joint. Remove immediately all remains of adhesive from the surface of the profile.
5. Fill the joints between the profile and the tiles with grout, in order to avoid water stagnation. Remove immediately all the remains of grout from the surface of the profile.

**ANODIZED ALUM. SILVER, POLISHED CHROME ALUMINIUM**  
thermo packed - bar length 2,7 lm - pack. 40 Pcs - 108 lm  
ADAPTOR LED, LED & FLAT NOT INCLUDED

Article	H mm		
PLTLEDA 20	20		
PLTLEDB 20	20		

**ADHESIVE FLEXIBLE LED COIL**  
length 5 lm - pack. 1 ROLL

Article			
LEDN			
LEDF			
LEDC			

### COLOURS

AA - Anodized silver alum.	BC - Polished chrome alum.
----------------------------	----------------------------

**POLYCARBONATE FLAT** bar length 2,7 lm - pack. 20 Pcs - 54 lm  
(AL = transparent / AO = matt)

Article			
PIAL 17			
PIAO 17			

**END CAPS - R/L** (3 right & 3 left)

Article	H mm		
TPLTLEDA 20	20		
TPLTLEDB 20	20		

**LED ADAPTOR AC/DC 75W - 12V (15 lm)**

Article			
ALL 7512			

**LED ADAPTOR AC/DC 25W - 12V (5 lm)**

Article			
ALL 2512			

\* = Production on demand with minimum quantity of 100 pcs. Production delay 4/5 weeks. Price to be agreed

# PROFINLIST 20

ANODIZED, POLISHED, BRUSHED AND TILTEX ALUMINIUM

PROFINLIST 20 is a listel in anodized, polished, brushed and tiltex aluminium with a flat visible surface, suitable to decorate the wall coverings in ceramic, mosaic and natural stone. Its particular section and availability in different finishes, make PROFINLIST 20 a much sought after profile. It can be used with the range of PROJOLLY profiles to decorate the wall coverings and to allow an elegant workmanlike application.

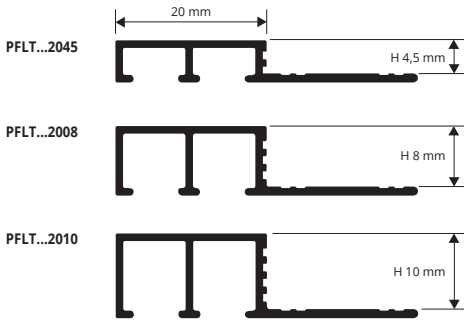

## EXAMPLES AND INSTRUCTIONS FOR LAYING METHODS

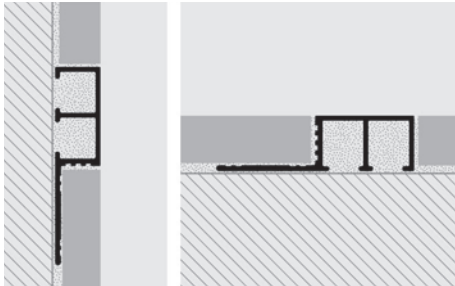

1. Choose "PROFINLIST 20" according to the width and desired finish.
2. Cut "PROFINLIST 20" to the desired length and apply the adhesive on the support where the profile will be laid.
3. Press the anchoring flange of "PROFINLIST 20" into the adhesive.
4. Lay the tiles, aligning them with the profile leaving a 2 mm joint. Remove immediately all remains of adhesive from the surface of the profile.
5. Fill the joints between the profile and the tiles with grout, in order to avoid water stagnation. Remove immediately all the remains of grout from the surface of the profile.



ANODIZED ALUMINIUM thermo packed  
bar length 2,7 lm - pack. 40 Pcs - 108 lm



POLISHED ALUMINIUM thermo packed  
bar length 2,7 lm - pack. 40 Pcs - 108 lm

Article	H mm		
PFLTAA 2045	4,5		*
PFLTAA 2008	8		
PFLTAR 2008	8		
PFLTAT 2008	8		
PFLTAA 2010	10		
PFLTAR 2010	10		
PFLTAT 2010	10		

Article	H mm		
PFLTBC 2045	4,5		
PFLTBO 2045	4,5		
PFLTBC 2008	8		
PFLTBR 2008	8		
PFLTBT 2008	8		
PFLTBC 2010	10		
PFLTBO 2010	10		
PFLTBR 2010	10		
PFLTBT 2010	10		

BRUSHED POLISHED ALUMINIUM thermo packed  
bar length 2,7 lm - pack. 40 Pcs - 108 lm

Article	H mm		
PFLTBS 2045	4,5		
PFLTBS 2008	8		
PFLTRS 2008	8		
PFLTTS 2008	8		
PFLTBS 2010	10		
PFLTRS 2010	10		
PFLTTS 2010	10		
PFLTBS 2010	10		

BRUSHED TILTEX ALUMINIUM thermo packed  
bar length 2,7 lm - pack. 40 Pcs - 108 lm

Article	H mm		
PFLTBX 2008	8		
PFLTRX 2008	8		
PFLTXX 2008	8		
PFLTBX 2010	10		
PFLTRX 2010	10		
PFLTXX 2010	10		



## COLOURS

ANODIZED	
	AA - Satin anodized silver alu.
POLISHED	
	BC - Polished chrome alu.
	BO - Polished gold alum.
BRUSHED POLISHED	
	BS - Brushed silver alu.
	BOS - Brushed gold alu.
ANOD. BRUSHED TILTEX	
	BX - Silver TILTEX

## AVAILABLE MINIMUM QUANTITY 100 PCS

by colour and height (Price to be agreed. Production delay 4/5 weeks)

ANODIZED	
	AR - Anodized copper alum.
	AT - Anodized titanium alum.
POLISHED	
	BR - Polished copper alum.
	BT - Polished titanium alum.
SPAZZ. BRILLANT.	
	RS - All. spazz. brill. rame
	TS - All. spazz. brill. titanio
ANOD. SPAZZOLATI TILTEX	
	RX - Brushed tiltex copper alum.
	TX - Titanium tiltex

\* = Production on demand with minimum quantity of 100 pcs. Production delay 4/5 weeks. Price to be agreed



**PROBORD** is a round corner bead profile in polished and brushed stainless steel AISI 304/1.4301-V2A suitable to protect the external corner of wall coverings in ceramic. Its particular section and availability in different finishes, make **PROBORD** a much sought after profile. It can be used with the range of PROLISTEL and PROSHELL profiles to obtain an elegant workmanlike application even in environments subject to high mechanical stresses.

# PROBORD

POLISHED AND BRUSHED STAINLESS STEEL  
AISI 304/1.4301-V2A



**POLISHED STAINLESS ST. AISI 304/1.4301-V2A with protective film**  
bar length 2,7 lm - pack. 15 Pcs - 40,5 lm - 10/10mm

Article	H mm
PEBDAC 08	08
PEBDAC 10	10
PEBDAC 125	12,5

**BRUSHED STAINLESS ST. AISI 304/1.4301-V2A with protective film**  
bar length 2,7 lm - pack. 15 Pcs - 40,5 lm - 10/10mm

Article	H mm
PEBDACS 08	08
PEBDACS 10	10
PEBDACS 125	12,5

### COLOURS



AC - Polished stainless steel AISI 304/1.4301-V2A  
ACS - Brushed stainless steel AISI 304/1.4301-V2A

SUITABLE FOR USE IN CONTACT WITH FOODSTUFFS.

### EXAMPLES AND INSTRUCTIONS FOR LAYING METHODS

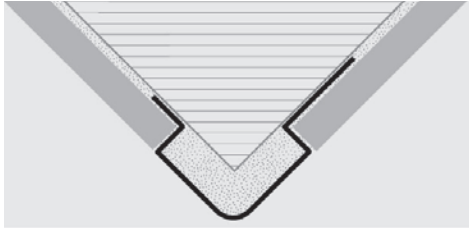

1. Choose "PROBORD" according to the tile thickness and desired finish.
2. Cut "PROBORD" to the desired length and apply the adhesive on the support where the profile will be laid.
3. Press the anchoring flange of "PROBORD" into the adhesive.
4. Lay the tiles, aligning them with the profile leaving a 2 mm joint. Remove immediately all remains of adhesive from the surface of the profile.
5. Fill the joints between the profile and the tiles with grout, in order to avoid water stagnation. Remove immediately all the remains of grout from the surface of the profile.

### PEBDAC/ACS 08

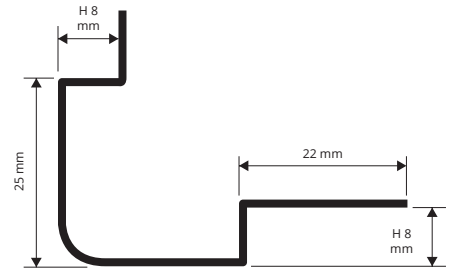

### PEBDAC/ACS 10

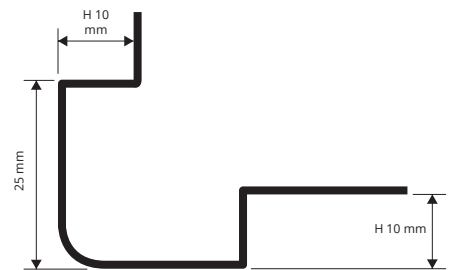

### PEBDAC/ACS 125

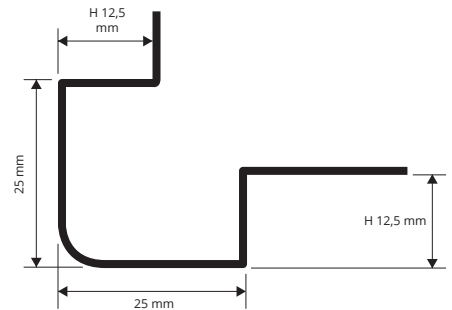

**PROEDGE FLEX** is a corner bead profile in shockproof non-toxic co-extruded colored vinyl resin composed by an internal rigid structure and by a soft external one. The profile is suitably shaped to protect the external corner of wall coverings. Its particular section and the availability in different colours make **PROEDGE FLEX** a much sought after and easy to lay profile that allows a workmanlike application.

# PROEDGE FLEX

SHOCKPROOF NON - TOXIC CO-EXTRUDED  
COLORED VINYL RESIN

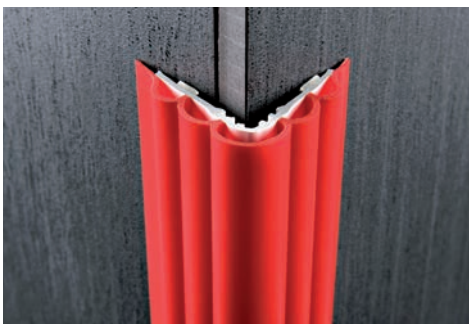

**CO-EXTRUDED PVC - L 40 X 40 mm**  
bar length 2,7 lm - pack. 15 Pcs - 40,5 lm

Article	H mm
PFC...40	40



**CO-EXTRUDED PVC WITH ADHESIVE - L 40 X 40 mm**  
bar length 2,7 lm - pack. 15 Pcs - 40,5 lm

Article	H mm
PFC...40A	40

### PFC... 40/40A

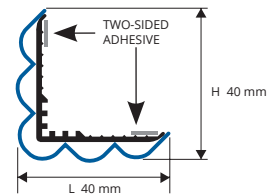

### EXAMPLES AND INSTRUCTIONS FOR LAYING METHODS



1. Choose "PROEDGE FLEX" according to the desired colour.
2. Cut "PROEDGE FLEX" to the desired length.
3. Remove carefully any remains of oil, fat and dirt from the surface where the profile will be laid.
4. When the surface is perfectly dry, remove the protective film (version with adhesive), place correctly the profile and press it without hitting / apply the silicone on the surface where the profile will be laid (version without adhesive) and press it without hitting.

### COLOURS



01 - White

AVAILABLE MINIMUM QUANTITY 100 PCS by colour and height (Price to be agreed. Production delay 4/5 weeks)

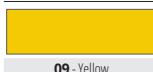

09 - Yellow



10 - Red



11 - Black



16 - Blue

# PROEDGE AC

POLISHED AND BRUSHED  
STAINLESS STEEL AISI 304/1.4301-V2A

**PROEDGE AC** is a corner bead profile in polished and brushed stainless steel AISI 304/1.4301-V2A, with a radius of curvature of 1.5 mm, suitably shaped to protect the external corner of wall coverings. Its particular section, the availability in two finishes and different widths make **PROEDGE AC** a much sought-after profile that allows a workmanlike application even in environments subject to high mechanical stresses.

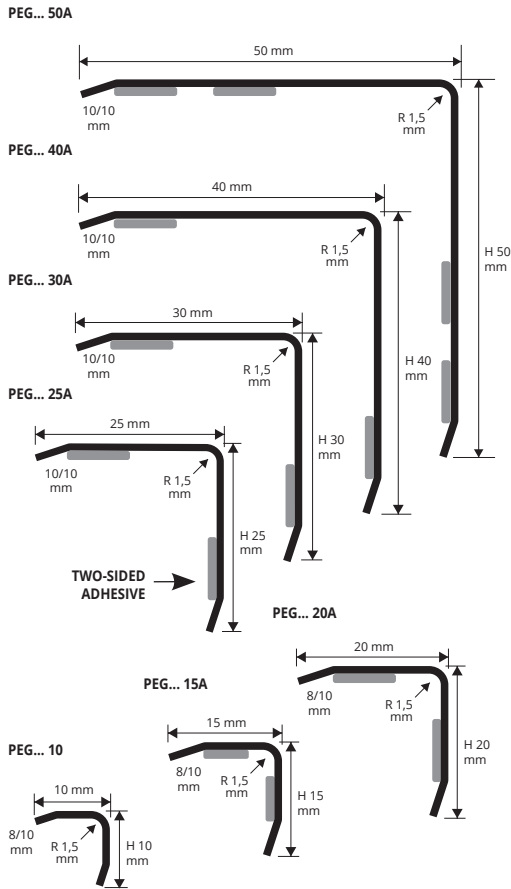

**POLISHED AND BRUSHED STAINLESS STEEL with protective film - bar length 2,7 lm - pack. 81 lm - 8/10 mm**

Article	LxH mm		
PEGAC 10	10 x 10		
PEGACS 10	10 x 10		

**POLISHED AND BRUSHED STAINLESS STEEL WITH ADHESIVE with protective film - bar length 2,7 lm - pack. 81 lm - 8/10 mm**

Article	LxH mm		
PEGAC 15A	15 x 15		
PEGACS 15A	15 x 15		
PEGAC 20A	20 x 20		
PEGACS 20A	20 x 20		

For items without adhesive, write the item without the last A.  
E.g.: PEGAC 10

### COLOURS



Suitable for use in contact with foodstuffs.



**POLISHED AND BRUSHED STAINLESS STEEL WITH ADHESIVE with protective film - bar length 2,7 lm - pack. 40,5 lm - 10/10 mm**

Article	LxH mm		
PEGAC 25A	25 x 25		
PEGACS 25A	25 x 25		
PEGAC 30A	30 x 30		
PEGACS 30A	30 x 30		

For items without adhesive write the item without the last A.  
E.g.: PEGAC 10

**POLISHED AND BRUSHED STAINLESS STEEL WITH ADHESIVE with protective film - bar length 2,7 lm - pack. 27 lm - 10/10 mm**

Article	LxH mm		
PEGAC 40A	40 x 40		
PEGACS 40A	40 x 40		
PEGAC 50A	50 x 50		
PEGACS 50A	50 x 50		

For items without adhesive, write the item without the last A.  
E.g.: PEGAC 40

PEG... 40A / 50A on demand with thickness 12/10.  
Quantity, timing and prices to be agreed.

# PROEDGE OT

POLISHED AND CHROMED BRASS

**PROEDGE OT** is a corner bead profile in polished and chromed brass, with a radius of curvature of 1.5 mm, suitably shaped to protect the external corner of wall coverings. Its particular section, the availability in two finishes and different widths make **PROEDGE OT** a much sought-after profile that allows an elegant workmanlike application.

### EXAMPLES AND INSTRUCTIONS FOR LAYING METHODS

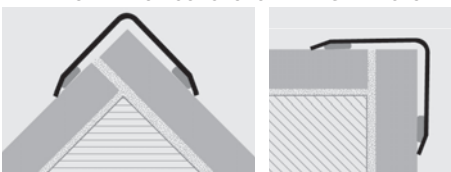

1. Choose "PROEDGE OT" according to the desired finish and width.
2. Cut "PROEDGE OT" to the desired length.
3. Remove carefully any remains of oil, fat and dirt from the surface where the profile will be laid.
4. When the surface is perfectly dry, remove the protective film, place correctly the profile and press it without hitting / apply the silicone on the surface where the profile will be laid (version without adhesive) and press it without hitting.

### COLOURS

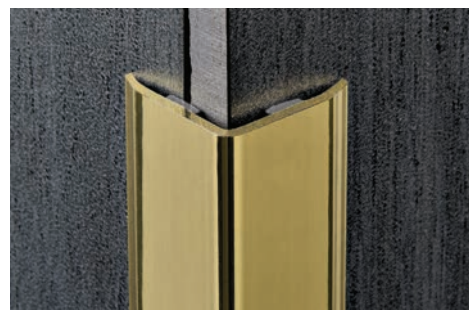

**POLISHED AND CHROMED BRASS**  
bar length 2,7 lm - pack. 54 lm - 8/10 mm

Article	LxH mm		
PEGOL 10	10 x 10		
PEGOC 10	10 x 10		

**POLISHED AND CHROMED BRASS WITH ADHESIVE**  
bar length 2,7 lm - pack. 54 lm - 8/10 mm

Article	LxH mm		
PEGOL 15A	15 x 15		
PEGOC 15A	15 x 15		
PEGOL 20A	20 x 20		
PEGOC 20A	20 x 20		
PEGOL 25A	25 x 25		
PEGOC 25A	25 x 25		
PEGOL 30A	30 x 30		
PEGOC 30A	30 x 30		

For items without adhesive, write the item without the last A.  
E.g.: PEGOL 15



**POLISHED BRASS WITH ADHESIVE**  
bar length 2,7 lm - pack. 27 lm - 10/10 mm

Article	LxH mm		
PEGOL 25A	25 x 25		
PEGOL 30A	30 x 30		

**POLISHED BRASS WITH ADHESIVE**  
bar length 2,7 lm - pack. 27 lm - 12/10 mm

Article	LxH mm		
PEGOL 40A	40 x 40		
PEGOL 50A	50 x 50		

PEG... 40A / 50A on demand with thickness 12/10.  
Quantity, timing and prices to be agreed.

For items without adhesive, write the item without the last A.  
E.g.: PEGOL 40

\* = Production on demand with minimum quantity of 100 pcs. Production delay 4/5 weeks. Price to be agreed

**PROEDGE R AC** is a corner bead profile in polished and brushed stainless steel AISI 304/1.4301-V2A, with a radius of curvature of 5 mm, suitably shaped to protect the external corner of wall coverings. Its particular section, the availability in two finishes and different widths make **PROEDGE R AC** a much sought-after profile that allows a workmanlike application even in environments subject to high mechanical stresses.

# PROEDGE R AC

POLISHED AND BRUSHED  
STAINLESS STEEL AISI 304/1.4301-V2A



**POLISHED AND BRUSHED STAINLESS STEEL WITH ADHESIVE with protective film** - bar length 2,7 lm - pack. 81 lm - 8/10 mm

Article	LxH mm
PEGRAC 15A	15 x 15
PEGRACS 15A	15 x 15
PEGRAC 20A	20 x 20
PEGRACS 20A	20 x 20

**POLISHED AND BRUSHED STAINLESS STEEL WITH ADHESIVE with protective film** - bar length 2,7 lm - pack. 40,5 lm - 10/10 mm

Article	LxH mm
PEGRAC 25A	25 x 25
PEGRACS 25A	25 x 25
PEGRAC 30A	30 x 30
PEGRACS 30A	30 x 30

For items without adhesive write the item without the last A.  
E.g.: PEGRAC 15

Suitable for use in contact with foodstuffs.

**POLISHED AND BRUSHED STAINLESS STEEL WITH ADHESIVE with protective film** - bar length 2,7 lm - pack. 27 lm - 10/10 mm

Article	LxH mm
PEGRAC 40A	40 x 40
PEGRACS 40A	40 x 40
PEGRAC 50A	50 x 50
PEGRACS 50A	50 x 50

PEGR... 40A / 50A on demand with thickness 12/10.  
Quantity, timing and prices to be agreed.

For items without adhesive, write the item without the last A.  
E.g.: PEGRAC 40

### COLOURS



PEG... 50A

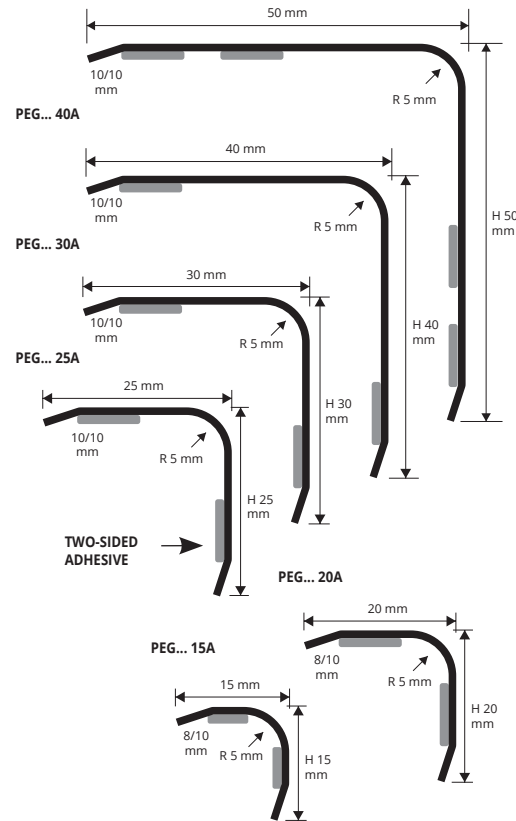

**PROEDGE R OT** is a corner bead profile in polished and chromed brass, with a radius of curvature of 5 mm, suitably shaped to protect the external corner of wall coverings. Its particular section, the availability in two finishes and different widths make **PROEDGE R OT** a much sought-after profile that allows an elegant workmanlike application.

# PROEDGE R OT

POLISHED AND CHROMED BRASS



**CHROMED BRASS WITH ADHESIVE thermo packed** - bar length 2,7 lm - pack. 54 lm

Article	LxH mm
PEGROC 15A	15 x 15
PEGROC 20A	20 x 20
PEGROC 25A	25 x 25
PEGROC 30A	30 x 30



**POLISHED BRASS WITH ADHESIVE**  
bar length 2,7 lm - pack. 54 lm - 8/10 mm

Article	LxH mm
PEGROL 15A	15 x 15
PEGROL 20A	20 x 20



For items without adhesive, write the item without the last A.  
E.g.: PEGROL 15

**POLISHED BRASS WITH ADHESIVE**  
bar length 2,7 lm - pack. 27 lm - 10/10 mm

Article	LxH mm
PEGROL 25A	25 x 25
PEGROL 30A	30 x 30



**POLISHED BRASS WITH ADHESIVE**  
bar length 2,7 lm - pack. 27 lm - 12/10 mm

Article	LxH mm
PEGROL 40A	40 x 40
PEGROL 50A	50 x 50



PEGR... 40A / 50A on demand with thickness 12/10.  
Quantity, timing and prices to be agreed.

For items without adhesive, write the item without the last A.  
E.g.: PEGROL 25

### EXAMPLES AND INSTRUCTIONS FOR LAYING METHODS

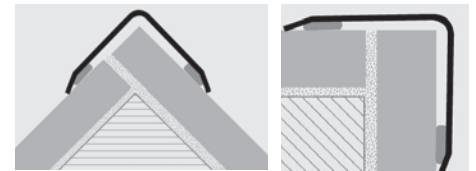

1. Choose "PROEDGE R OT" according to the desired finish and width.  
2. Cut "PROEDGE R OT" to the desired length. 3. Remove carefully any remains of oil, fat and dirt from the surface where the profile will be laid. 4. When the surface is perfectly dry, remove the protective film, place correctly the profile and press it without hitting / apply the silicone on the surface where the profile will be laid (version without adhesive) and press it without hitting.

### COLOURS



\* = Production on demand with minimum quantity of 100 pcs. Production delay 4/5 weeks. Price to be agreed

# PROEDGE AL

PROEDGE AL is a corner bead profile in anodized and varnished aluminium suitably shaped to protect the external corner of wall coverings. Its particular section and the availability in four different finishes make PROEDGE AL a much sought-after profile that allows a workmanlike application.

ANODIZED AND VARNISHED ALUMINIUM

PEG... 25A  
PEGA 25-01A

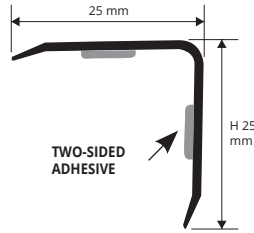

## EXAMPLES AND INSTRUCTIONS FOR LAYING METHODS



1. Choose "PROEDGE AL" according to the desired finish and width.
2. Cut "PROEDGE AL" to the desired length.
3. Remove carefully any remains of oil, fat and dirt from the surface where the profile will be laid.
4. When the surface is perfectly dry, remove the protective film, place correctly the profile and press it without hitting / apply the silicone on the surface where the profile will be laid (version without adhesive) and press it without hitting.

**ANODIZED ALUM. (gold, silver and bronze) WITH ADHESIVE**  
thermo packed - bar length 2,7 lm - pack. 30 Pcs - 81 lm

Article	LxH mm		
PEGAO 25A	25 x 25		
PEGAA 25A	25 x 25		
PEGAB 25A	25 x 25		

For items without adhesive, write the article without the last A.  
E.g.: PEGAO 25

**WHITE VARNISHED ALUMINIUM - WITH ADHESIVE**  
thermo packed - bar length 2,7 lm - pack. 30 Pcs - 81 lm

Article	LxH mm		
PEGA 25-01A	25 x 25		

## COLOURS

ANODIZED		
AO - Anodized gold alum.	AA - Anodized silver alum.	AB - Anod. bronze alum.
01 - White varnished alum.		

# PROEDGE PVC

PROEDGE PVC is a corner bead profile in shockproof non-toxic co-extruded white vinyl resin suitably shaped to protect the external corner of wall coverings. Its particular section and the availability in four different widths make PROEDGE PVC a much sought-after profile that allows a workmanlike application.

SHOCKPROOF NON - TOXIC CO-EXTRUDED  
WHITE VINYL RESIN

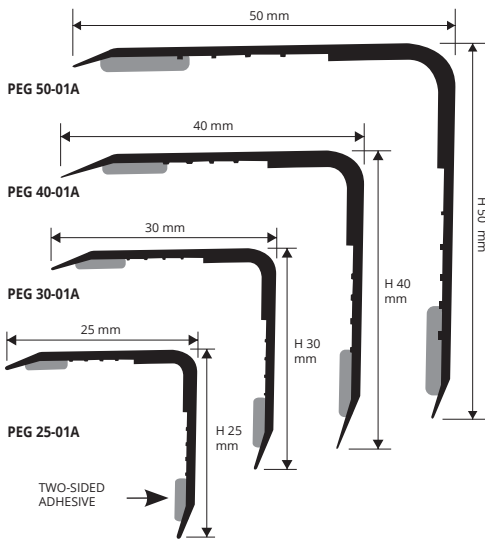

## EXAMPLES AND INSTRUCTIONS FOR LAYING METHODS



**SHOCKPROOF VINYL RESIN WITH ADHESIVE**  
bar length 2,7 lm - pack. 30 Pcs - 81 lm

Article	LxH mm		
PEG 25-01A	25 x 25		
PEG 30-01A	30 x 30		

**SHOCKPROOF VINYL RESIN WITHOUT ADHESIVE**  
bar length 2,7 lm - pack. 30 Pcs - 81 lm

Article	LxH mm		
PEG 25-01	25 x 25		
PEG 30-01	30 x 30		

**SHOCKPROOF VINYL RESIN WITH ADHESIVE**  
bar length 2,7 lm - pack. 15 Pcs - 40,5 lm

Article	LxH mm		
PEG 40-01A	40 x 40		
PEG 50-01A	50 x 50		

**SHOCKPROOF VINYL RESIN WITHOUT ADHESIVE**  
bar length 2,7 lm - pack. 15 Pcs - 40,5 lm

Article	LxH mm		
PEG 40-01	40 x 40		
PEG 50-01	50 x 50		

## COLOURS

01 - White

**FOR OTHER COLORS MINIMUM  
ORDER 400 pcs**

1. Choose "PROEDGE PVC" according to the desired width.
2. Cut "PROEDGE PVC" to the desired length.
3. Remove carefully any remains of oil, fat and dirt from the surface where the profile will be laid.
4. When the surface is perfectly dry, remove the protective film, place correctly the profile and press it without hitting / apply the silicone on the surface where the profile will be laid (version without adhesive) and press it without hitting.



# PROSHELL

POLISHED AND BRUSHED  
STAINLESS STEEL AISI 304/1.4301-V2A

PROSHELL is a cove-shaped profile in polished and brushed stainless steel AISI 304/1.4301-V2A particularly suitable to ensure cleanliness and hygiene in every kind of environment where high resistance to mechanical and chemical stresses are required. Its particular section and the availability in two finishes, four heights and special pieces, such as internal and external corners, end caps and junctions, make PROSHELL a much sought-after profile that allows a workmanlike application even in environments subject to high mechanical stresses.

internal seal hygienic profiles

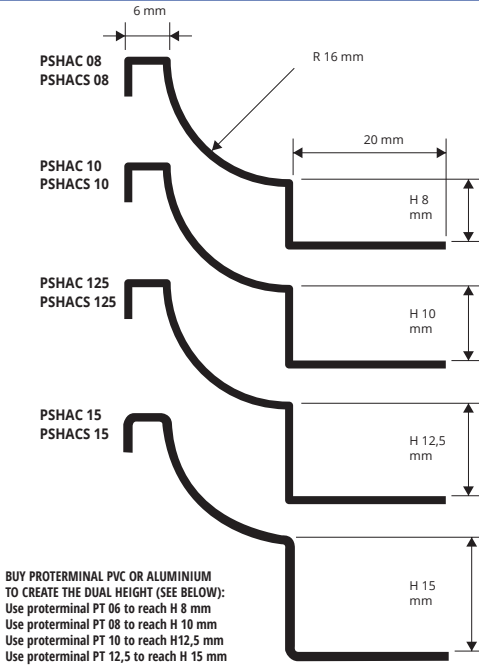

### EXAMPLES FOR LAYING

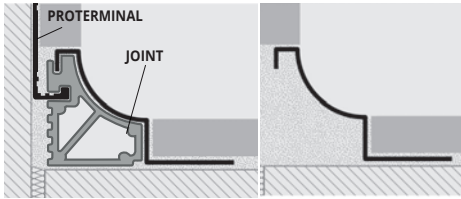

POLISHED STAINLESS STEEL AISI 304/1.4301-V2A with protective film  
- bar length 2,7 lm - pack. 20 Pcs - 54 lm - 10/10 mm

Article	H mm		
PSHAC 08	8		
PSHAC 10	10		
PSHAC 125	12,5		
PSHAC 15	15		



BRUSHED STAINLESS STEEL AISI 304/1.4301-V2A with protective film - bar  
length 2,7 lm - pack. 20 Pcs - 54 lm - 10/10 mm

Article	H mm		
PSHACS 08	8		
PSHACS 10	10		
PSHACS 125	12,5		
PSHACS 15	15		

Suitable for use in contact with foodstuffs.

### INSTRUCTIONS FOR LAYING

1. Choose "PROSHELL" according to the tile thickness and desired finish. (\*) 2. Cut "PROSHELL" to the desired length and apply the adhesive on the support where the profile will be laid. 3. Press the anchoring flange of "PROSHELL" into the adhesive. 4. Lay the tiles on floor and wall aligning them with the profile leaving a 2 mm joint. Remove immediately all remains of adhesive from the surface of the profile. 5. Fill the joints between the profile and the tiles with grout, in order to avoid water stagnation. Remove immediately all the remains of grout from the surface of the profile. (\*) to obtain double height, use the joint of the same size as the selected profile and choose the PROTERMINAL PVC or ALUMINIUM according to the required thickness, see INSTRUCTIONS FOR LAYING.

### COLOURS



# PREWELDED CORNER, CAPS and THREE-WAYS JOINTS

POLISHED AND BRUSHED STAINLESS STEEL

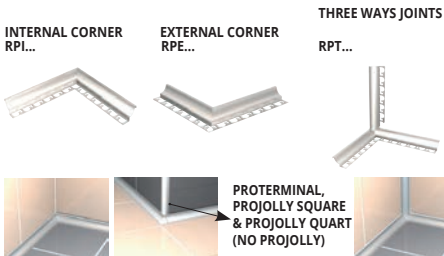

PREWELDED CORNER - POLISHED STAINLESS STEEL  
L 100 mm - pack. 10 Pcs

Article	H mm		
RPI .../10	08/10/125		
RPI 15/10	15		
RPE .../10	08/10/125		
RPE 15/10	15		
RPT .../10	08/10/125		
RPT 15/10	15		

Specify height of joint: E.g.: RPI 8 for H 8 mm.

PREWELDED CORNER - BRUSHED STAINLESS STEEL  
L 100 mm - pack. 10 Pcs

Article	H mm		
RPIS .../10	08/10/125		
RPIS 15/10	15		
RPES .../10	08/10/125		
RPES 15/10	15		
RPTS .../10	08/10/125		
RPTS 15/10	15		

Specify height of joint: E.g.: RPIS 8 for H 8 mm.



OVERLAPPING JOINTS  
POLISHED AISI 316/.4404 V4A STAINLESS STEEL - pack. 10 Pcs

Article			
RPSIACM/10			
RPSEACM/10			
RPSTACM/10			
GPSACM/10			
TPSACM/10			

OVERLAPPING JOINTS  
BRUSHED AISI 316/.4404 V4A STAINLESS STEEL - pack. 10 Pcs

Article			
RPSIACMS/10			
RPSEACMS/10			
RPSTACMS/10			
GPSACMS/10			
TPSACMS/10			

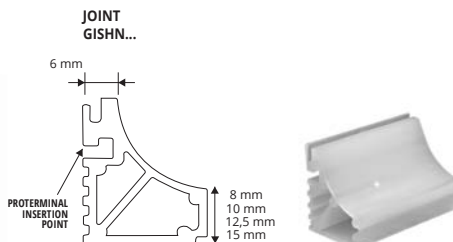
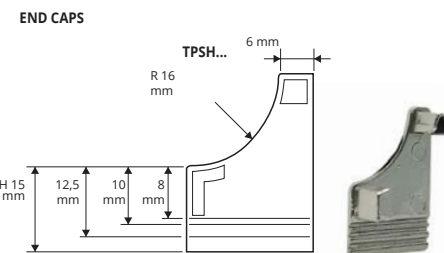

CAPS AND JOINTS IN RIGID GREY PLASTIC  
pack. 10 Pcs

Article			
TPSHAC/10			
TPSHACS/10			
GISHN 08/10			
GISHN 10/10			
GISHN 125/10			
GISHN 15/10			

**PROSHELL** is a cove-shaped profile in polished and brushed stainless steel AISI 316L/1.4404-V4A particularly suitable to ensure cleanliness and hygiene in every kind of environment where high resistance to mechanical and chemical stresses are required. Its particular section and the availability in two finishes, four heights and special pieces, such as internal and external corners, end caps and junctions, make **PROSHELL** a much sought-after profile that allows a workmanlike application even in environments subject to high mechanical stresses.

# PROSHELL

POLISHED AND BRUSHED STAINLESS STEEL AISI 316L/1.4404-V4A



**POLISHED STAINLESS STEEL AISI 316L/1.4404-V4A with protective film**  
- bar length 2,7 lm - pack. 20 Pcs - 54 lm - 10/10 mm



**BRUSHED STAINLESS STEEL AISI 316L/1.4404-V4A with protective film**  
- bar length 2,7 lm - pack. 20 Pcs - 54 lm - 10/10 mm



Article	H mm
PSHACM 08	8
PSHACM 10	10
PSHACM 125	12,5
PSHACM 15	15

Article	H mm
PSHACMS 08	8
PSHACMS 10	10
PSHACMS 125	12,5
PSHACMS 15	15

Suitable for use in contact with foodstuffs.

## COLOURS



ACM - Polished stainless steel AISI 316L/1.4404-V4A  
ACMS - Brushed stainless steel AISI 316L/1.4404-V4A

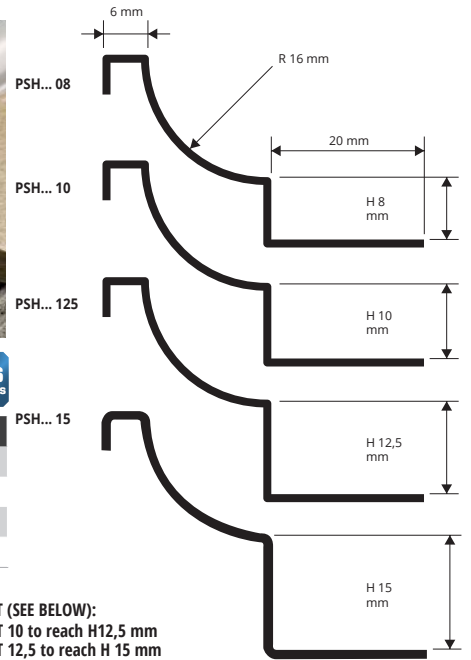

Internal seal hygienic profiles

**BUY PROTERMINAL PVC OR ALUMINIUM TO CREATE THE DUAL HEIGHT (SEE BELOW):**  
Use proterminal PT 06 to reach H 8 mm      Use proterminal PT 10 to reach H12,5 mm  
Use proterminal PT 08 to reach H 10 mm      Use proterminal PT 12,5 to reach H 15 mm

### EXAMPLES AND INSTRUCTIONS FOR LAYING

1. Choose "PROSHELL" according to the tile thickness and desired finish. (\*) 2. Cut "PROSHELL" to the desired length and apply the adhesive on the support where the profile will be laid. 3. Press the anchoring flange of "PROSHELL" into the adhesive. 4. Lay the tiles on floor and wall aligning them with the profile leaving a 2 mm joint. Remove immediately all remains of adhesive from the surface of the profile. 5. Fill the joints between the profile and the tiles with grout, in order to avoid water stagnation. Remove immediately all the remains of grout from the surface of the profile. (\*) to obtain double height, use the joint of the same size as the selected profile and choose the PROTERMINAL PVC or ALUMINIUM according to the required thickness, see INSTRUCTIONS FOR LAYING.

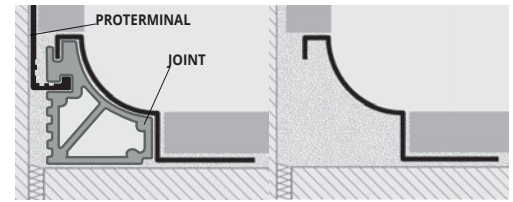

# PREWELDED CORNER, CAPS and THREE-WAYS JOINTS

POLISHED AND BRUSHED STAINLESS STEEL

**PREWELDED CORNER - POLISHED STAINLESS STEEL**  
L 100 mm - pack. 10 Pcs

Article	H mm
RPIACM .../10	08/10/125
RPIACM 15/10	15
RPEACM .../10	08/10/125
RPEACM 15/10	15
RPTACM .../10	08/10/125
RPTACM 15/10	15

Specify height of joint: E.g.: RPI 8 for H 8 mm.

**PREWELDED CORNER - BRUSHED STAINLESS STEEL**  
L 100 mm - pack. 10 Pcs

Article	H mm
RPIACMS .../10	08/10/125
RPISACMS 15/10	15
RPESACMS .../10	08/10/125
RPESACMS 15/10	15
RPTSACMS .../10	08/10/125
RPTSACMS 15/10	15

Specify height of joint: E.g.: RPIS 8 for H 8 mm.

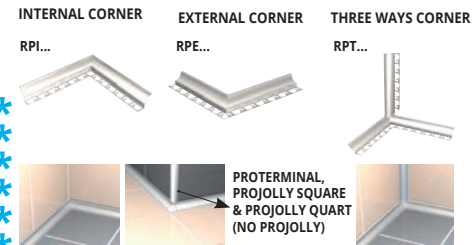

**OVERLAPPING JOINTS**  
POLISHED AISI 316/.4404 V4A STAINLESS STEEL - pack. 10 Pcs



Article
RPSIACM/10
RPSEACM/10
RPSTACM/10
GPSACM/10
TPSACM/10

**OVERLAPPING JOINTS**  
BRUSHED AISI 316/.4404 V4A STAINLESS STEEL - pack. 10 Pcs



Article
RPSIACMS/10
RPSEACMS/10
RPSTACMS/10
GPSACMS/10
TPSACMS/10



**CAPS AND JOINTS IN RIGID GREY PLASTIC**  
pack. 10 Pcs

Article
TPSHAC/10
TPSHACS/10
GISHN 08/10
GISHN 10/10
GISHN 125/10
GISHN 15/10

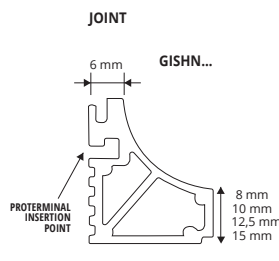

### END CAPS

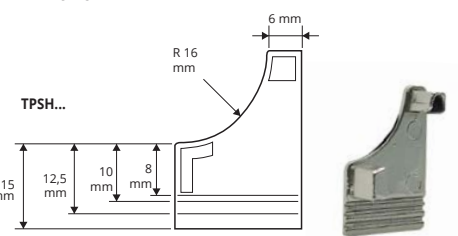

\*\*\* = Production on demand with minimum quantity of 20 pcs. Production delay 4/5 weeks. Price to be agreed

\* = Production on demand with minimum quantity of 200 pcs. Production delay 4/5 weeks. Price to be agreed

News 2021

# PROSHELL ALL

ANODIZED, POLISHED AND VARNISHED ALUMINIUM

**PROSHELL ALL** is a cove-shaped profile in anodized, polished and varnished aluminium particularly suitable to ensure cleanliness and hygiene in indoors environment where good resistance to mechanical and chemical stresses are required. Its particular section and the availability in three finishes, three heights and special pieces, such as internal and external corners, end caps and junctions, make **PROSHELL ALL** a much sought-after profile that allows a workmanlike application.

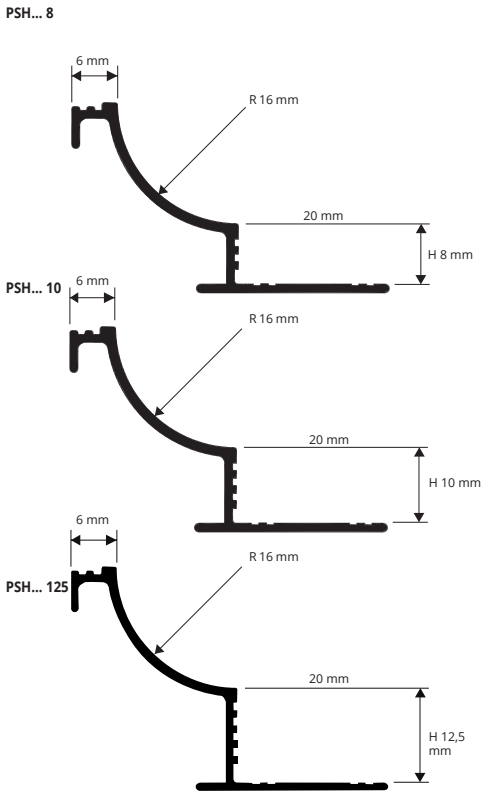

BUY PROTERMINAL PVC OR ALUMINIUM TO CREATE THE DUAL HEIGHT (SEE NEXT PIC):  
 Use proterminal PT 08 to reach H 10 mm  
 Use proterminal PT 10 to reach H 12,5 mm  
 Use proterminal PT 12,5 to reach H 15 mm



**ANODIZED SILVER ALUMINIUM thermo packed**  
 bar length 2,7 lm - pack. 20 Pcs - 54 lm

Article	H mm		
PSHAA 08	8		
PSHAA 10	10		
PSHAA 125	12,5		

**VARNISHED WHITE ALUMINIUM thermo packed**  
 bar length 2,7 lm - pack. 20 Pcs - 54 lm

Article	H mm		
PSHA 08-01	8		
PSHA 10-01	10		
PSHA 125-01	12,5		

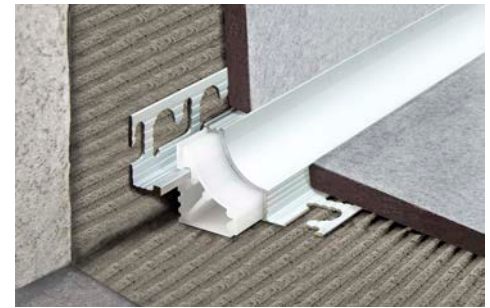

**POLISHED CHROME ALUMINIUM thermo packed**  
 bar length 2,7 lm - pack. 20 Pcs - 54 lm

Article	H mm		
PSHBC 08	8		
PSHBC 10	10		
PSHBC 125	12,5		

### COLOURS

AA - Anod. Silver alum.	BC - Polished chrome alum.	01 - White varnished alum.

### EXAMPLES AND INSTRUCTIONS FOR LAYING METHODS

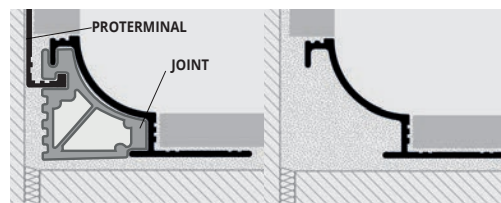

1. Choose "PROSHELL ALL" according to the tile thickness and desired finish. 2. Cut "PROSHELL ALL" to the desired length and apply the adhesive on the support where the profile will be laid. 3. Press the anchoring flange of "PROSHELL ALL" into the adhesive. 4. Lay the tiles on floor and wall aligning them with the profile leaving a 2 mm joint. Remove immediately all remains of adhesive from the surface of the profile. 5. Fill the joints between the profile and the tiles with grout, in order to avoid water stagnation. Remove immediately all the remains of grout from the surface of the profile. (\*) to obtain double height, use the joint of the same size as the selected profile and choose the PROTERMINAL PVC or ALUMINIUM according to the required thickness, see INSTRUCTIONS FOR LAYING.

## CORNERS, END CAPS and JOINTS

SILVER ANODIZED, POLISHED CHROME AND VARNISHED WHITE ALUMINIUM / PLASTIC

\* accessories of the on demand profiles are also on demand



### EXTERNAL/INTERNAL CORNER - ANODIZED SILVER ALUMINIUM

Article	H mm	Pack 10 Pcs	Pack 2 Pcs
RPSHIAA .../...	08/10/125		
RPSHEAA .../...	08/10/125		

### EXTERNAL/INTERNAL CORNER POLISHED CHROME ALUMINIUM

Article	H mm	Pack 10 Pcs	Pack 2 Pcs
RPSHIBC .../...	08/10/125		
RPSHEBC .../...	08/10/125		

### EXTERNAL/INTERNAL CORNER VARNISHED WHITE ALUMINIUM

Article	H mm	Pack 10 Pcs	Pack 2 Pcs
RPSHIA ...-01/...	08/10/125		
RPSHEA ...-01/...	08/10/125		

**CAPS - ANODIZED SILVER ALUMINIUM/POLISHED CHROME/VARNISHED WHITE ALUM.**  
 pack. 10 Pcs (5 right and 5 left) - pack. 2 Pcs (1 right and 1 left)

Article	H mm	Pack 10 Pcs	Pack 2 Pcs
TPSHAA 08/...	8		
TPSHBC 08/...	8		
TPSHA 08/...	8		
TPSHAA 10/...	10		
TPSHBC 10/...	10		
TPSHA 10/...	10		
TPSHAA 125/...	12,5		
TPSHBC 125/...	12,5		
TPSHA 125/...	12,5		

Choose the desired packaging. E.g.: TPSH... -01/5 (Pack 10 Pcs)  
 TPSH... -01/1 (Pack 2 Pcs)

### JOINTS IN RIGID GREY PLASTIC - pack. 10 Pcs

Article	H mm		
GISHN 08/...	8		
GISHN 10/...	10		
GISHN 125/...	12,5		

INTERNAL CORNER  
RPSHI.../...



EXTERNAL CORNER  
RPSHE.../...



END CAP  
TPSH.../...

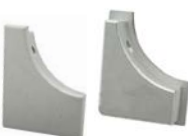

JOINT  
GISHN.../...





**PROSGUSCIO DA** is a cove-shaped profile in shockproof non - toxic coloured vinyl resin particularly suitable to ensure cleanliness and hygiene in public and industrial environments. Its particular section, the availability in three finishes, four heights and special pieces, such as internal and external corners, end caps and junctions, make **PROSGUSCIO DA** a much sought-after profile that allows a workmanlike application.

# PROSGUSCIO DA

SHOCKPROOF NON - TOXIC COLOURED VINYL RESIN



## EXAMPLES AND INSTRUCTIONS FOR LAYING METHODS

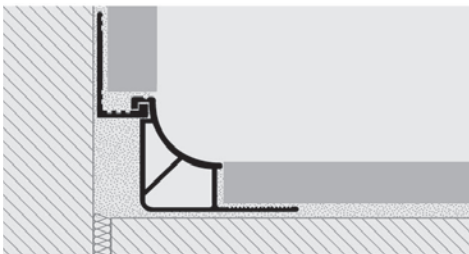
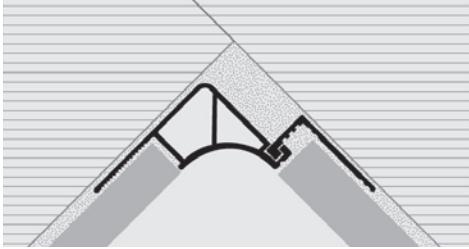

1. Choose "PROSGUSCIO DA" according to the tile thickness and desired colour. 2. Cut "PROSGUSCIO DA" to the desired length and apply the adhesive on the support where the profile will be laid. 3. Press the anchoring flange of "PROSGUSCIO DA" into the adhesive. 4. Lay the tiles on floor and wall aligning them with the profile leaving a 2 mm joint. 5. Fill the joints between the profile and the tiles with grout, in order to avoid water stagnation.

## NON-TOXIC SHOCKPROOF VINYL RESIN

bar length 2,5 lm - pack. 20 Pcs - 50 lm

Article	H mm
PS 06-...	6
PS 08-...	8
PS 10-...	10
PS 125-...	12,5

H 06 available in the colours: 01-04.  
H 08, H 10 and H 125 available in the colours: 01-03-04.  
The code of the selected colour must be added to the article code.  
E.g.: PS 06... (chosen colour white) PS 06-01. The interchangeable flange corresponds to white Proterminal pvc H 6-8-10 mm.

## COLOURS

01 - White	03 - Cement gray	04 - Light Beige

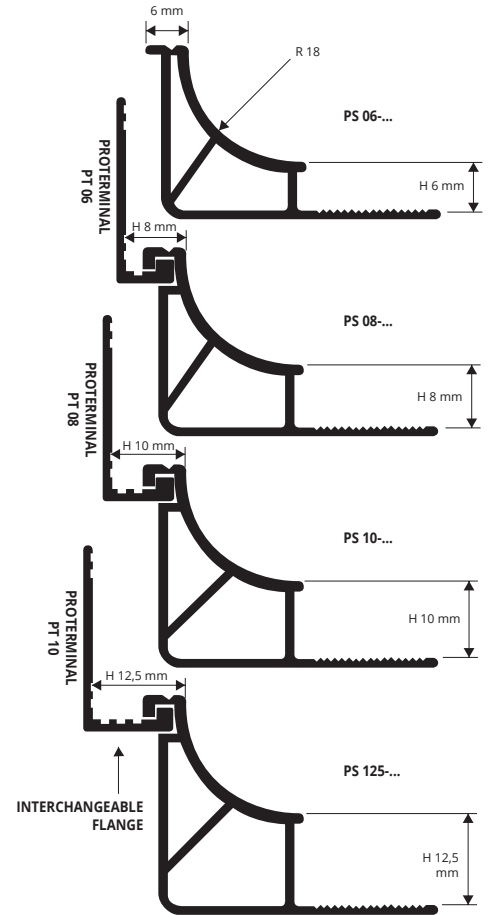

BUY WHITE PROTERMINAL TO CREATE THE DUAL HEIGHT:  
Use proterminal PT 06 to reach H 8 mm  
Use proterminal PT 08 to reach H 10 mm  
Use proterminal PT 10 to reach H 12,5 mm

# CORNERS, END CAPS and JOINTS

NON- TOXIC VINYL RESIN - 3 COLOURS

## EXTERNAL / INTERNAL CORNER - RVA COLOURED

Article	H mm	Pack 2 Pcs	Pack 10 Pcs
RAI ...-.../...	06/08/10/125		
RAE ...-.../...	06/08/10/125		

Available in the colours: 01 - 03 - 04.  
The code of the selected colour must be added to the article code.  
E.g.: RAI 06-... (chosen colour white) RAI 06-01.

Choose the desired packaging. Ex. RAI 06-01/10 (pack. 10 Pcs)  
RAI 06-01/2 (pack. 2 Pcs)

## END CAP RT / LF - RVA COLOURED

pack. 10 Pcs (5 right and 5 left) - pack. 2 Pcs (1 right and 1 left)

Article	H mm	Pack 2 Pcs	Pack 10 Pcs
TCE 06-.../...	06/08/10/125		

Available in the colours: 01 - 03 - 04.  
The code of the selected colour must be added to the article code.  
E.g.: TCE 08-... (chosen colour white) TCE 08-01.  
Choose the desired packaging. Ex. TCE 08-01/5 (pack. 10 Pcs)  
TCE 08-01/1 (pack. 2 Pcs)

## JOINTS - RVA COLOURED

pack. 10 Pcs - pack. 2 Pcs

Article	H mm	Pack 2 Pcs	Pack 10 Pcs
GIN ...-.../...	06/08/10/125		

Available in the colours: 01 - 03 - 04.  
The code of the selected colour must be added to the article code.  
E.g.: GIN 08-... (chosen colour white) GIN 08-01.

Choose the desired packaging. Ex. GIN 08-01/10 (pack. 10 Pcs)  
GIN 08-01/2 (pack. 2 Pcs)



PROJOLLY - PROJOLLY QUART

INTERNAL CORNER  
RAI...-.../...



EXTERNAL CORNER  
RAE...-.../...



END CAP  
TCE...-.../...



JOINT  
GIN...-.../...



# PROROUND

POLISHED AND BRUSHED STAINLESS STEEL AISI 304/1.4301-V2A

**PROROUND** is a cove-shaped profile in polished and brushed stainless steel AISI 304/1.4301-V2A particularly suitable to ensure cleanliness and hygiene in every kind of environment where high resistance to mechanical and chemical stresses are required. Its particular section and the availability in two finishes and special pieces, such as internal and external corners, make **PROROUND** a much sought-after profile that allows a workmanlike application even in environments subject to high mechanical stresses.

internal seal hygienic profiles

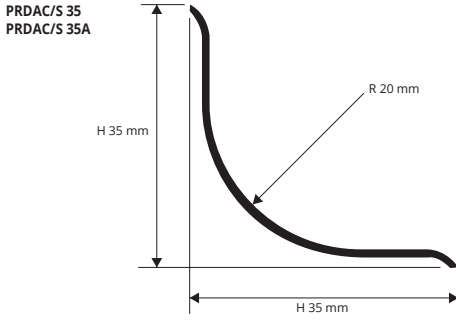

### EXAMPLES OF LAYING

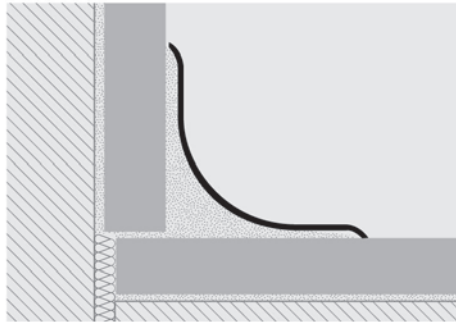

**POLISHED STAINLESS ST. AISI 304/1.4301-V2A with protective film**  
35 x 35 mm - bar length 2,7 lm - pack. 20 Pcs - 54 lm - 10/10 mm

Article	H mm
PRDAC 35	35
PRDAC 35A	35

1. Choose "PROROUND" according to the desired finish and width.
2. Cut "PROROUND" to the desired length.
3. Remove carefully any remains of oil, fat and dirt from the surface where the profile will be laid.
4. When the surface is perfectly dry, remove the protective film, place correctly the profile and press it without hitting / apply the silicone on the surface where the profile will be laid (version without adhesive) and press it without hitting.



**BRUSHED STAINLESS ST. AISI 304/1.4301-V2A with protective film**  
35 x 35 mm - bar length 2,7 lm - pack. 20 Pcs - 54 lm - 10/10 mm

Article	H mm
PRDACS 35	35
PRDACS 35A	35

### COLOURS



Suitable for use in contact with foodstuffs.

## PREWELDED CORNERS and THREE-WAYS JOINTS without gaps

POLISHED AND BRUSHED STAINLESS STEEL

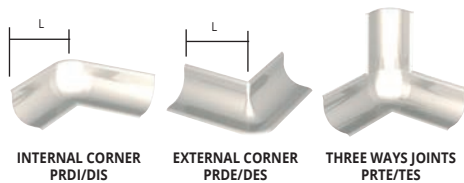

**POLISHED STAINLESS STEEL AISI 304/1.4301-V2A - pack. 10 Pcs**

Article	L mm
PRDI/10	100
PRDE/10	100
PRTE/10	80

**Brushed STAINLESS STEEL AISI 304/1.4301-V2A - pack. 10 Pcs**

Article	L mm
PRDIS/10	100
PRDES/10	100
PRTES/10	80

## PROSANI STRIP & PROSANI STRIP KIT

NON-TOXIC FLEXIBLE WHITE VINYL RESIN

**PROSANI STRIP** and **PROSANI STRIP KIT** are profiles in non-toxic flexible white vinyl resin particularly suitable to ensure cleanliness and hygiene along the connection between the wall tile coverings and sinks, bathtubs and shower trays. **PROSANI STRIP KIT** is provided with a double-sided butyl tape while **PROSANI STRIP** can be applied with silicone. Their particular section and ease of application, and make **PROSANI STRIP KIT** and **PROSANI STRIP** a much sought after profiles that allow a workmanlike application.

internal seal hygienic profiles

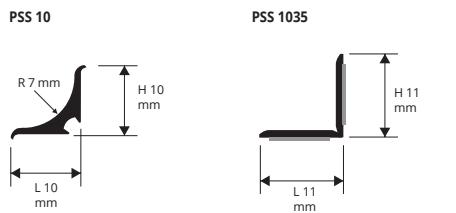

### EXAMPLES AND INSTRUCTIONS FOR LAYING METHODS

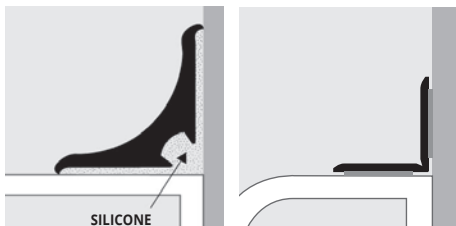

1. Choose the desired profile.
2. Cut the profile to the desired length.
3. Remove carefully any remains of oil, fat and dirt from the surface where the profile will be laid.
4. When the surface is perfectly dry, remove the protective film (PROSANI STRIP KIT), place correctly the profile and press it without hitting / apply the equipment double-sided butyl tape on the back of the profile (PROSANI STRIP), apply the silicone along the floor-wall joint and place the profile.



### FLEXIBLE WHITE VINYL RESIN

roll 25 lm

Article	LxH mm
PSS 10	10 X 10

### PROSANI STRIP KIT ROLL - WHITE

roll 3,5 lm

Article	LxH mm
PSS 1035	11 X 11



### COLOURS

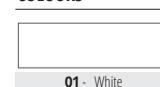

**PROSEAL 50** is a cove-shaped profile in shockproof non - toxic coextruded coloured vinyl resin particularly suitable to ensure cleanliness and hygiene in public and industrial environments. Its particular section and the availability in two different colours and special pieces, such as internal and external corners, end caps and joints, make **PROSEAL 50** a much sought-after profile that allows a workmanlike application.

# PROSEAL 50

SHOCKPROOF NON - TOXIC COEXTRUDED COLORED VINYL RESIN



**COEXTRUDED VINYL RESIN NON-TOXIC SHOCKPROOF**  
bar length 2,5 lm - Pack. 40 LM

Article		
PSA 50-...		

Available in the colours: 01 - 03 (on demand 04).  
The code of the selected colour must be added to the article code.  
E.g.: PSA 50... (chosen colour white) PSA 50-01.

**COEXTRUDED VINYL RESIN NON-TOXIC SHOCKPROOF - ADHESIVE**  
bar length 2,5 lm - Pack. 30 LM

Article		
PSAA 50-...		

Available in the colours: 01 - 03 (on demand 04).  
The code of the selected colour must be added to the article code.  
E.g.: PSAA 50... (chosen colour white) PSAA 50-01.

## COLOURS

01 - White	03 - Cement Grey

04 - Light Beige

**AVAILABLE MINIMUM QUANTITY 100 PCS** By colour and height  
(Price and delivery time to be agreed)

PSA 50-... / PSAA 50-...

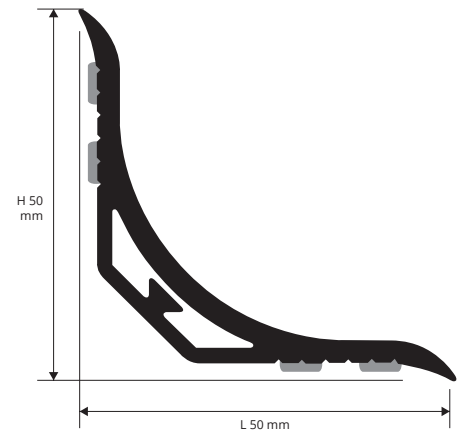

internal seal hygienic profiles

## EXAMPLES AND INSTRUCTIONS FOR LAYING METHODS

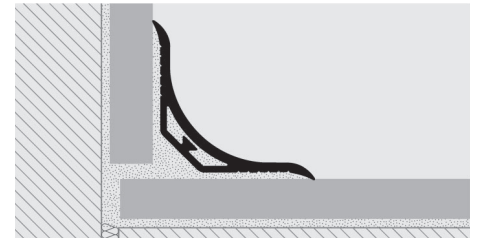

1. Choose "PROSEAL 50" according to the tile thickness and desired finish. 2. Cut "PROSEAL 50" to the desired length. 3. Remove carefully any remains of oil, fat and dirt from the surface where the profile will be laid. 4. When the surface is perfectly dry, remove the protective film (version with adhesive), place the profile and press it without hitting / apply the double-sided butyl tape on the back of the profile (version without adhesive), apply the silicone along the floor-wall joint and place the profile.

# CORNERS and END CAPS

NON - TOXIC VINYL RESIN

**INTERNAL / EXTERNAL CORNER AND END CAPS** (for PROSEAL 50)

Article	Pack. 2 Pcs	Pack. 10 Pcs
TRI 50-.../...		
TRE 50-.../...		
TRT 50-.../...		
TRC 50-.../...		
TGN 50-.../...		

Available in the colours: 01 - 03 (on demand 04).  
The code of the selected colour must be added to the article code.  
E.g.: TRI 50-... (chosen colour white) TRI 50-01.

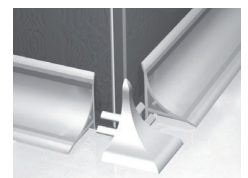
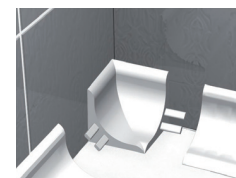
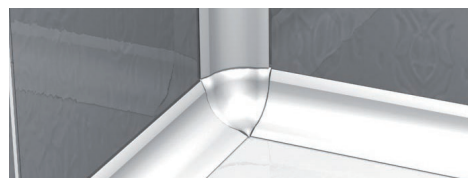

EXTERNAL CORNER

THREE WAYS

END CAP

JOINTS

INTERNAL CORNER

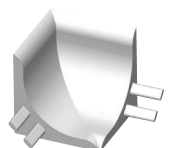
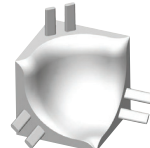

TRI 50-.../...

TRT 50-.../...

TRC 50-.../...

TGN 50-.../...

TRI 50-.../...



# PROSEAL 25

SHOCKPROOF NON - TOXIC COEXTRUDED COLORED VINYL RESIN

**PROSEAL 25** is a cove-shaped profile in shockproof non - toxic coextruded coloured vinyl resin particularly suitable to ensure cleanliness and hygiene in public and industrial environments. Its particular section and the availability in three different colours and special pieces, such as internal and external corners, end caps and joints, make **PROSEAL 25** a much sought-after profile that allows a workmanlike application.

internal seal hygienic profiles

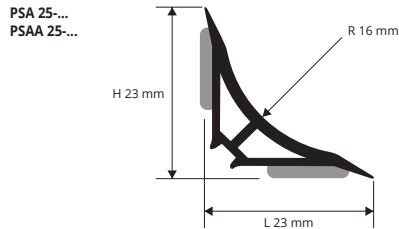

### EXAMPLES AND INSTRUCTIONS FOR LAYING METHODS

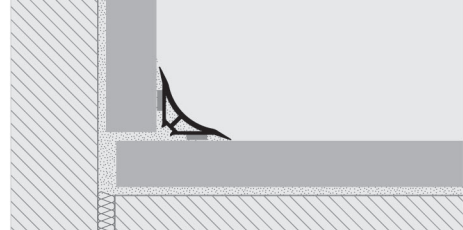

1. Choose "PROSEAL 25" according to the tile thickness and desired finish. 2. Cut "PROSEAL 25" to the desired length. 3. Remove carefully any remains of oil, fat and dirt from the surface where the profile will be laid. 4. When the surface is perfectly dry, remove the protective film (version with adhesive), place the profile and press it without hitting / apply the double-sided butyl tape on the back of the profile (version without adhesive), apply the silicone along the floor-wall joint and place the profile.



**COEXTRUDED VINYL RESIN NON-TOXIC SHOCKPROOF**  
bar length **2,5 lm** - pack. **50 LM**

Article		
<b>PSA 25-...</b>		

Available in the colours: 01 - 03 - 04.  
The code of the selected colour must be added to the article code.  
E.g.: PSA 25-... (chosen colour white) PSA 25-01..

**COEXTRUDED VINYL RESIN NON-TOXIC SHOCKPROOF ADHESIVE**  
bar length **2,5 lm** - pack. **50 LM**

Article		
<b>PSAA 25-...</b>		

Available in the colours: 01 - 03 - 04.  
The code of the selected colour must be added to the article code.  
E.g.: PSAA 25-... (chosen colour white) PSAA 25-01..

### COLOURS

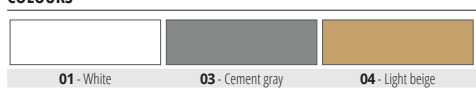

**PROSEAL KIT 25** (1 Pc of 1,80 LM + 2 Pcs of 0,90 lm + 2 INTERNAL CORNERS and 2 END CAPS 1 R and 1 L)

Description	Article
Kit PROSEAL 25	<b>KTPSA 25-01</b>
<b>1</b> Pc PROSEAL 25 of 1,80 lm	<b>PSA 25-01</b>
<b>2</b> Pcs PROSEAL 25 of 0,90 lm	<b>PSA 25-01</b>
<b>2</b> Internal corner	<b>TRI 25-01</b>
<b>2</b> End caps	<b>TRC 2501</b>

# CORNERS, END CAPS and THREE-WAYS JOINTS

NON - TOXIC VINYL RESIN

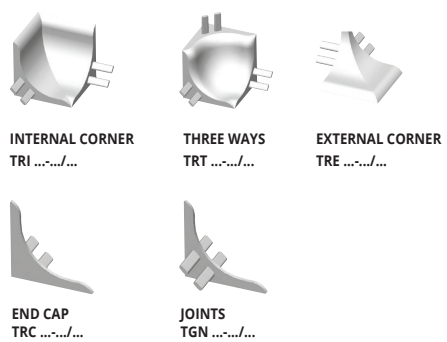

**INTERNAL / EXTERNAL CORNERS AND END CAPS** (for PROSEAL 25)

Article	Pack. 2 Pcs	Pack. 10 Pcs
<b>TRI 25-.../...</b>		
<b>TRE 25-.../...</b>		
<b>TRT 25-.../...</b>		
<b>TRC 25-.../...</b>		
<b>TGN 25-.../...</b>		

Available in the colours: 01 - 03 - 04.  
The code of the selected colour must be added to the article code.  
E.g.: TRI 25-... (chosen colour white) TRI 25-01.  
Choose the desired packaging. Ex. TRI 25-01/10 (pack. 10 Pcs) TRI 25-01/2 (pack. 2 Pcs)

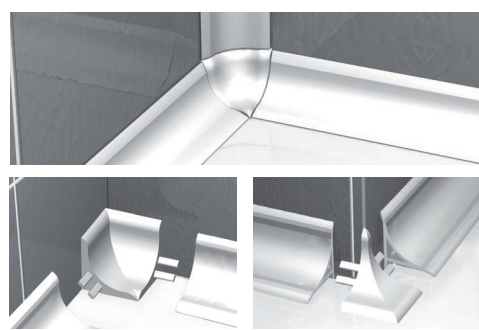

# PROSEAL FLEX

NON-TOXIC FLEXIBLE VINYL RESIN

**PROSEAL FLEX** is a flexible non-toxic vinyl resin profile suitable to realize cove-shaped connection with resilient flooring in public and industrial environments. Its particular section makes **PROSEAL FLEX** a very sought after profile that allows that allows a workmanlike application.

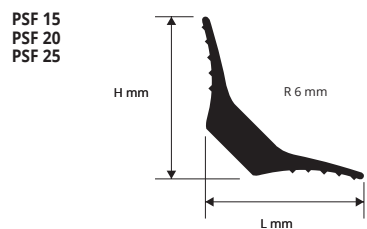

### INSTRUCTIONS FOR LAYING

1. Apply a suitable adhesive for resilient flooring on the support. 2. Place "PROSEAL FLEX" over the adhesive. 3. Apply the adhesive on the profile and the support and lay the resilient flooring.

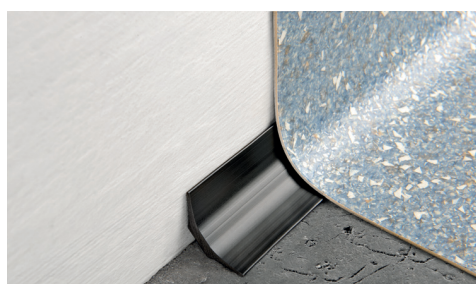

**FLEXIBLE BLACK NON-TOXIC VYNIL RESIN**  
bar length **2,5 lm** - pack. **40 Pcs - 100 lm**

Article	L x H mm		
<b>PSF 15-11</b>	<b>15x15</b>		
<b>PSF 20-11</b>	<b>20x20</b>		
<b>PSF 25-11</b>	<b>25x25</b>		

### COLOURS

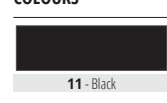

**PROBATH** is a cove-shaped profile in shockproof non - toxic coextruded white vinyl resin particularly suitable to ensure cleanliness and hygiene along the connection between the wall tile coverings and sinks, bathtubs and shower trays. Its particular section and the availability in two different height and special pieces, such as internal and external corners, (only for PSB-20) end caps and joints, make **PROBATH** a much sought-after and easy to lay profile that allows a workmanlike application.

# PROBATH

SHOCKPROOF NON - TOXIC COEXTRUDED VINYL RESIN



**CO-EXTRUDED VINYL RESIN NON - TOXIC IMPACT - RESISTANT**  
bar length 2,5 lm - pack. 40 Pcs - 100 lm

Article	H mm
PSB 15-01	15
PSB 20-01	20

AVAILABLE ONLY IN WHITE

### COLOURS



01 - White

FOR OTHER COLORS MINIMUM ORDER 400 pcs

**PROBATH KIT** (1 PC of 1,80 LM + 2 PCS of 0,90 LM + 2 INTERNAL CORNERS and 2 END CAPS 1 R and 1 L)

Description	Article
Kit PROBATH	KTPSB 20-01
1 Pc PROBATH of 1,80 lm	PSB 20-01
2 Pc PROBATH of 0,90 lm	PSB 20-01
2 Internal Corner	TRI 25-01
2 End caps	TRC 25-01

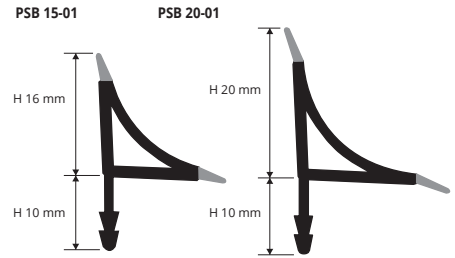

### EXAMPLES AND INSTRUCTIONS FOR LAYING METHODS

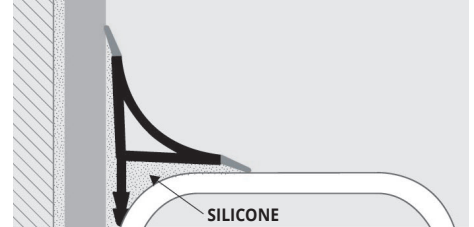

1. Choose "PROBATH" according to the desired height.
2. Cut "PROBATH" to the desired length.
3. Remove carefully any remains of oil, fat and dirt from the surface where the profile will be laid.
4. When the surface is perfectly dry apply the silicone on the back of the profile and place it without hitting.

internal seal hygienic profiles

**PROBATH FLEX** is a cove-shaped profile in shockproof non - toxic flexible white vinyl resin particularly suitable to ensure cleanliness and hygiene along the connection between the wall tile coverings and sinks, bathtubs and shower trays. Its particular section and the availability in two different height and special pieces, such as internal and external corners, (only for PSB-20) end caps and joints, make **PROBATH FLEX** a much sought-after and easy to lay profile that allows a workmanlike application.

# PROBATH FLEX

SHOCKPROOF NON - TOXIC FLEXIBLE VINYL RESIN



**FLEXIBLE WHITE VINYL RESIN**  
bar length 2,5 lm - pack. 40 Pcs - 100 lm

Article	H mm
PSBF 15-01	15
PSBF 20-01	20

AVAILABLE ONLY IN WHITE



01 - White

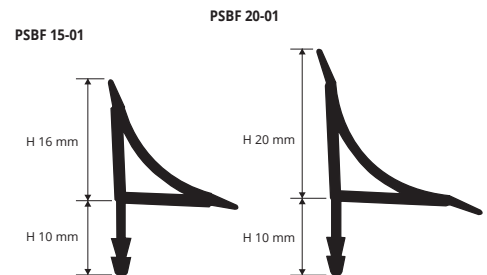

1. Choose "PROBATH FLEX" according to the desired height.
2. Cut "PROBATH FLEX" to the desired length.
3. Remove carefully any remains of oil, fat and dirt from the surface where the profile will be laid.
4. When the surface is perfectly dry apply the silicone on the back of the profile and place it without hitting.

internal seal hygienic profiles

# CORNERS, END CAPS and THREE-WAYS JOINTS

NON-TOXIC VINYL RESIN

### CORNERS INTERNAL / EXTERNAL, THREE-WAYS, JOINTS AND END CAP

Article	Pack. 2 Pcs	Pack. 10 Pcs
TRI 25-01/...		
TRE 25-01/...		
TRT 25-01/...		
TRC 25-01/...		
TGN 25-01/...		

Choose the desired packaging. Ex. TRI 25-01/10 (pack. 10 Pcs)  
TRI 25-01/2 (pack. 2 Pcs)

### CORNERS INTERNAL / EXTERNAL AND END CAP - (for PSB 15 - PSBF 15)

Article	Pack. 2 Pcs	Pack. 10 Pcs
TPSB 15-01/...		
RIPSB 15-01/...		
REPSB 15-01/...		

Choose the desired packaging. Ex. TPSB 15-01/10 (pack. 10 Pcs)  
TPSB 15-01/2 (pack. 2 Pcs)

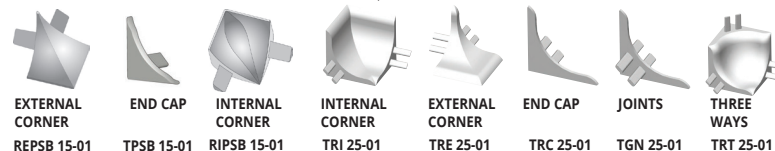

\* = Production on demand with minimum quantity of 400 pcs. Production delay 4/5 weeks. Price to be agreed



# PROKERLAM LINE

POLISHED AND BRUSHED STAINLESS STEEL AISI 304/1.4301-V2A

**PROKERLAM LINE** is a profile in polished and brushed stainless steel AISI 304/1.4301-V2A suitable to protect the external corners of coverings in low thickness. It can be used like connection profile between step tread and riser of stairs coated with ceramic and mosaic with low thickness. Its particular section and the availability in three different heights and finishes and special pieces such as internal and external corners, end caps and joints make **PROKERLAM LINE** a much sought-after profile that allows a workmanlike application even with low thickness coverings.

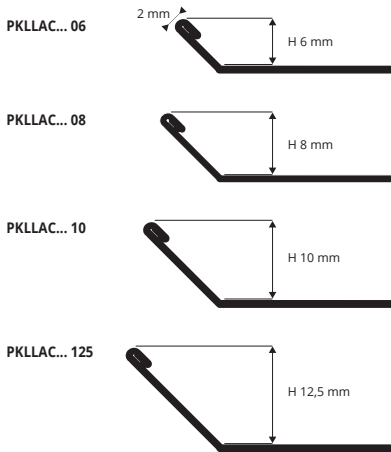

## LAYING INSTRUCTIONS

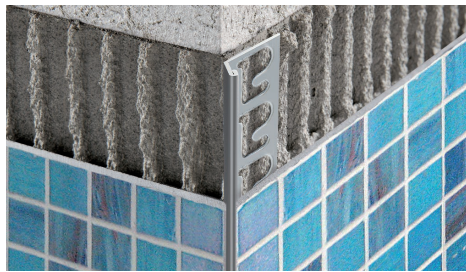

**POLISHED STAINLESS ST. AISI 304/1.4301-V2A with protective film**  
Bar lenght 2,7 lm - Pack 40 PCS - 108 lm

Article	H mm		
PKLLAC 06	6		
PKLLAC 08	8		
PKLLAC 10	10		
PKLLAC 125	12,5		

1. Choose "PROKERLAM LINE" according to the desired finish.
2. Cut "PROKERLAM LINE" to the desired length and apply the adhesive on the support where the profile will be laid.
3. Press the anchoring flange of "PROKERLAM LINE" into the adhesive.
4. Lay the tiles, aligning them with the profile leaving a 2 mm joint.
5. Remove immediately all remains of adhesive from the surface of the profile.
5. Fill the joints between the profile and the tiles with grout, in order to avoid water stagnation. Remove immediately all the remains of grout from the surface of the profile.



**BRUSHED STAINLESS ST. AISI 304/1.4301-V2A with protective film**  
Bar lenght 2,7 lm - Pack 40 PCS - 108 lm

Article	H mm		
PKLLACS 06	6		
PKLLACS 08	8		
PKLLACS 10	10		
PKLLACS 125	12,5		

## COLOURS



AC - Polished stainless steel AISI 304/1.4301-V2A ACS - Brushed stainless steel AISI 304/1.4301-V2A

# PROKERLAM LINE

ANODIZED, VARNISHED AND STONE LINE ALUMINIUM

**PROKERLAM LINE** is a Y-shaped profile in anodized and polished aluminium suitable to protect the external corners of coverings in low thickness. It can be used like connection profile between step tread and riser of stairs coated with ceramic and mosaic with low thickness. Its particular section and the availability in three different heights and finishes and special pieces such as internal and external corners, end caps and joints make **PROKERLAM LINE** a much sought-after profile that allows a workmanlike application even with low thickness coverings.

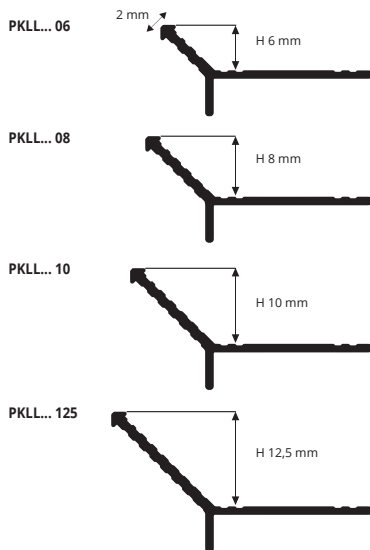

## LAYING INSTRUCTIONS

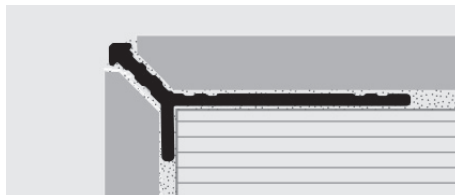

1. Choose "PROKERLAM LINE" according to the desired finish.
2. Cut "PROKERLAM LINE" to the desired length and apply the adhesive on the support where the profile will be laid.
3. Press the anchoring flange of "PROKERLAM LINE" into the adhesive.
4. Lay the tiles, aligning them with the profile leaving a 2 mm joint. Remove immediately all remains of adhesive from the surface of the profile.
5. Fill the joints between the profile and the tiles with grout, in order to avoid water stagnation. Remove immediately all the remains of grout from the surface of the profile.



**ANODISED SILVER ALUMINIUM thermo packed**  
Bar lenght 2,7 lm - Pack 40 PCS - 108 lm

Article	H mm		
PKLLAA 06	6		
PKLLAA 08	8		
PKLLAA 10	10		
PKLLAA 125	12,5		

**POLISHED CHROME ALUMINIUM thermo packed**  
Bar lenght 2,7 lm - Pack 40 PCS - 108 lm

Article	H mm		
PKLLBC 10	10		
PKLLBC 125	125		

## COLOURS

ANODIZED		POLISHED	
AA - Anodized Silver Alu.		BC - Polished chrome alu.	
VARNISHED			
01 - White Varnished Alu.		11 - Black Varnished Alu.	

STONE LINE				
SL02 - Stone cream	SL03 - Stone greywory	SL04 - Stone sand	SL05 - Stone grey	SL08 - Stone antradrak



**VARNISHED ALUMINIUM (White-Black) thermo packed**  
Bar lenght 2,7 lm - Pack 40 PCS - 108 lm

Article	H mm		
PKLLA 06-01	6		
PKLLA 06-11	6		
PKLLA 08-01	8		
PKLLA 08-11	8		
PKLLA 10-01	10		
PKLLA 10-11	10		
PKLLA 125-01	12,5		
PKLLA 125-11	12,5		

**STONE LINE ALUMINIUM thermo packed**  
Bar lenght 2,7 lm - Pack 40 PCS - 108 lm

Article	H mm		
PKLLA 06-SL...	6		
PKLLA 08-SL...	8		
PKLLA 10-SL...	10		
PKLLA 125-SL...	12,5		

The code of the selected colour must be added to the article code. E.g.: PKLLA 06-... (chosen colour stone cream) PKLLA 06-SL02.

**PROTERMSTEP ACC** is a profile for stair in polished and brushed stainless steel AISI 304/1.4301-V2A. The profile protects the tread and cover the joint between the tread and the riser of the step. It can also be used overturned and for this reason it is suitable for two different tile thickness. Its particular geometry and the availability of two finishes and different heights make **PROTERMSTEP ACC** suitable for every kind of stair with ceramic, terracotta floorings, wood and natural stone coverings.

# PROTERMSTEP ACC

POLISHED AND BRUSHED STAINLESS STEEL  
AISI 304/1.4301-V2A



**POLISHED STAINLESS ST. AISI 304/1.4301-V2A with protective film**  
bar length 2,7 lm - pack. 15 Pcs - 40,5 lm

Article	h / H mm		
PTSPAC 0815	08 / 15		
PTSPAC 10125	10 / 12,5		
PTSPAC 1530	15 / 30		
PTSPAC 2025	20 / 25		

### COLOURS



AC - Polished stainless steel AISI 304/1.4301-V2A



**BRUSHED STAINLESS STEEL AISI 304/1.4301-V2A**  
bar length 2,7 lm - pack. 15 Pcs - 40,5 lm

Article	h / H mm		
PTSPACS 0815	08 / 15		
PTSPACS 10125	10 / 12,5		
PTSPACS 1530	15 / 30		
PTSPACS 2025	20 / 25		

### ON DEMAND



ACS - Brushed stainless steel AISI 304/1.4301-V2A

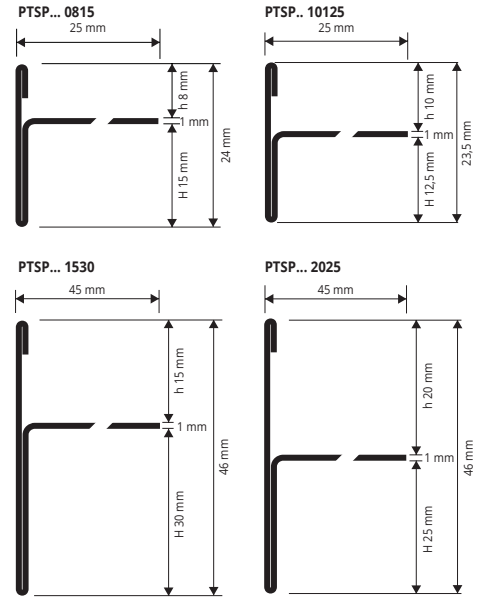

### INSTRUCTIONS FOR LAYING METHODS

1. Choose "PROTERMSTEP ACC" according to the tile thickness and desired finish.
2. Cut "PROTERMSTEP ACC" to the desired length.
3. Lay the raiser of the step and apply the adhesive on the support where the profile will be laid.
4. Press the anchoring flange of "PROTERMSTEP ACC" into the adhesive.
5. Lay the tiles aligning them with the profile leaving a 2 mm joint. Remove immediately all remains of adhesive from the surface of the profile.
6. Fill the joints between the profile and the tiles with grout, in order to avoid water stagnation. Remove immediately all the remains of grout from the surface of the profile.

## ANGLE AND JOINT

### CORNER - pack. 10 Pcs

Article	h / H mm		
REPTSAC 0815/10	08 / 15		
REPTSAC 10125/10	10 / 12,5		
REPTSAC 1530/10	15 / 30		
REPTSAC 2025/10	20 / 25		

### JOINT - pack. 10 Pcs

Article	h / H mm		
GIPTSAC 0815/10	08 / 15		
GIPTSAC 10125/10	10 / 12,5		
GIPTSAC 1530/10	15 / 30		
GIPTSAC 2025/10	20 / 25		

### JOINT GIPTSAC ..



### CORNER REPTSAC ..

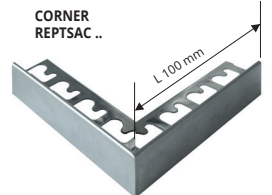

\* = Production on demand with minimum quantity of 100 pcs. Production delay 4/5 weeks. Price to be agreed

# PROTOP

ANODIZED AND POLISHED ALUMINIUM

**PROTOP** is a rounded profile in anodized and polished aluminium. The profile protects the tile edges and decorates the countertops of kitchens realized with ceramic. Its particular section and elegance, the availability of three different finishes and special pieces such as internal and external corner at 90° and 135°, make **PROTOP** a much sought-after profile that allows an elegant workmanlike application.

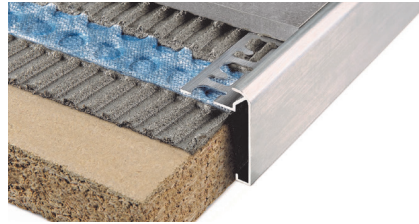
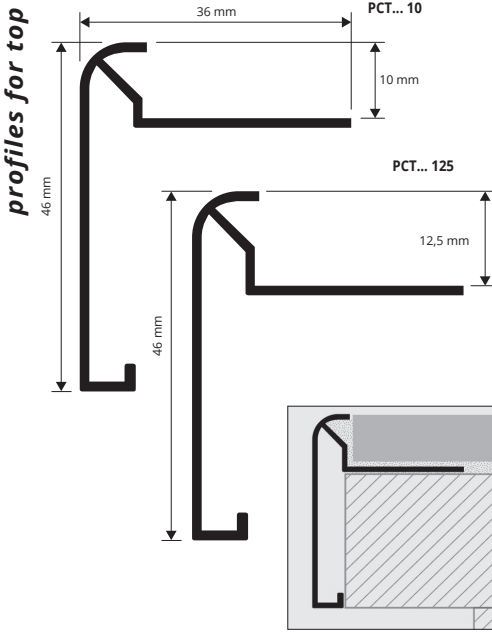

**ANODIZED SILVER ALUMINIUM**  
bar length 2,7 lm - pack. 10 Pcs - 27 lm

Article	H mm
PCTAA 10	10
PCTAA 125	12,5

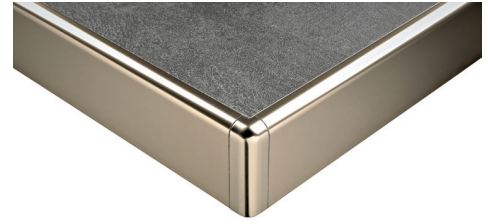

**POLISHED TITANIUM ALUMINIUM**  
bar length 2,7 lm - pack. 10 Pcs - 27 lm

Article	H mm
PCTBT 10	10
PCTBT 125	12,5

**POLISHED CHROME ALUMINIUM**  
bar length 2,7 lm - pack. 10 Pcs - 27 lm

Article	H mm
PCTBC 10	10
PCTBC 125	12,5

### COLOURS

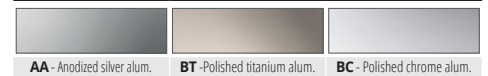

### EXAMPLES AND INSTRUCTIONS FOR LAYING METHODS

1. Choose "PROTOP" according to the tile thickness and desired finish.
2. Cut "PROTOP" to the desired length and apply the adhesive on the support where the profile will be laid.
3. Press the anchoring flange of "PROTOP" into the adhesive.
4. Lay the tiles, aligning them with the profile leaving a 2 mm joint. Remove immediately all remains of adhesive from the surface of the profile.
5. Fill the joints between the profile and the tiles with grout, in order to avoid water stagnation. Remove immediately all the remains of grout from the surface of the profile.

# CORNERS

**INTERNAL / EXTERNAL CORNERS ANODIZED SILVER ALUMINIUM**  
pack. 10 Pcs

Article
EPCTAA 90/10 (90°)
IPCTAA 90/10 (90°)
EPCTAA 135/10 (135°)
IPCTAA 135/10 (135°)

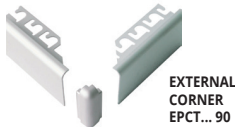

**INTERNAL / EXTERNAL CORNERS POLISHED TITANIUM ALUMINIUM**  
pack. 10 Pcs

Article
EPCTBT 90/10 (90°)
IPCTBT 90/10 (90°)
EPCTBT 135/10 (135°)
IPCTBT 135/10 (135°)



**INTERNAL / EXTERNAL CORNERS POLISHED CHROME ALUMINIUM**  
pack. 10 Pcs

Article
EPCTBC 90/10 (90°)
IPCTBC 90/10 (90°)
EPCTBC 135/10 (135°)
IPCTBC 135/10 (135°)



# PROTOP T

ANODIZED AND POLISHED ALUMINIUM

**PROTOP T** is a square profile in anodized and polished aluminium. The profile protects the tile edges and decorates the countertops of kitchens realized with ceramic. Its particular section and elegance, the availability of two different finishes and special pieces such as internal and external corner at 90° and 135°, make **PROTOP T** a much sought-after profile that allows an elegant workmanlike application.

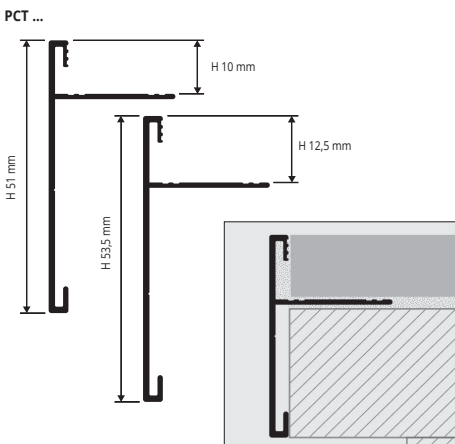

**ANODIZED SILVER ALUMINIUM**  
bar length 2,7 lm - pack. 10 Pcs - 27 lm

Article	H mm
PCTAA 10T	10
PCTAA 125T	12,5



**POLISHED CHROME ALUMINIUM**  
bar length 2,7 lm - pack. 10 Pcs - 27 lm

Article	H mm
PCTBC 10T	10
PCTBC 125T	12,5

**INTERNAL / EXTERNAL CORNER ANODIZED SILVER ALUMINIUM**  
pack. 10 Pcs

Article
IEPCTAA 12590T/10 (90°)
IEPCTAA 1090T/10 (90°)
IEPCTAA 10135T/10 (135°)
IEPCTAA 125135T/10 (135°)

**INTERNAL / EXTERNAL CORNER ANODIZED CHROME ALUMINIUM**  
pack. 10 Pcs

Article
IEPCTBC 12590T/10 (90°)
IEPCTBC 1090T/10 (90°)
IEPCTBC 10135T/10 (135°)
IEPCTBC 125135T/10 (135°)

### EXAMPLES AND INSTRUCTIONS FOR LAYING METHODS

1. Choose "PROTOP T" according to the tile thickness and desired finish.
2. Cut "PROTOP T" to the desired length and apply the adhesive on the support where the profile will be laid.
3. Press the anchoring flange of "PROTOP T" into the adhesive.
4. Lay the tiles, aligning them with the profile leaving a 2 mm joint. Remove immediately all remains of adhesive from the surface of the profile.
5. Fill the joints between the profile and the tiles with grout, in order to avoid water stagnation. Remove immediately all the remains of grout from the surface of the profile.



### COLOURS









An interpretation of:  
**Rublyovo - Arkhangelskoye smart city, Zaha Hadid, MOSCOW (Russia)**

PROFILES FOR FLOORS



# PROTERMINAL

POLISHED AND BRUSHED  
STAINLESS STEEL AISI 304/1.4301-V2A

**PROTERMINAL** is a professional edging profile used mainly to join similar or different floor materials (e.g. tiles/ tiles - parquet/marble/laminates/carpeting /linoleum, etc.) of differing thickness.

**PROTERMINAL** in stainless steel is also used to protect steps and decking, as a floor edging profile and skirting covering. Match with PROLISTEL strips in stainless steel AISI 304/1.4301-V2A with polished or brushed and in aluminium with anodized or polished chrome finish.

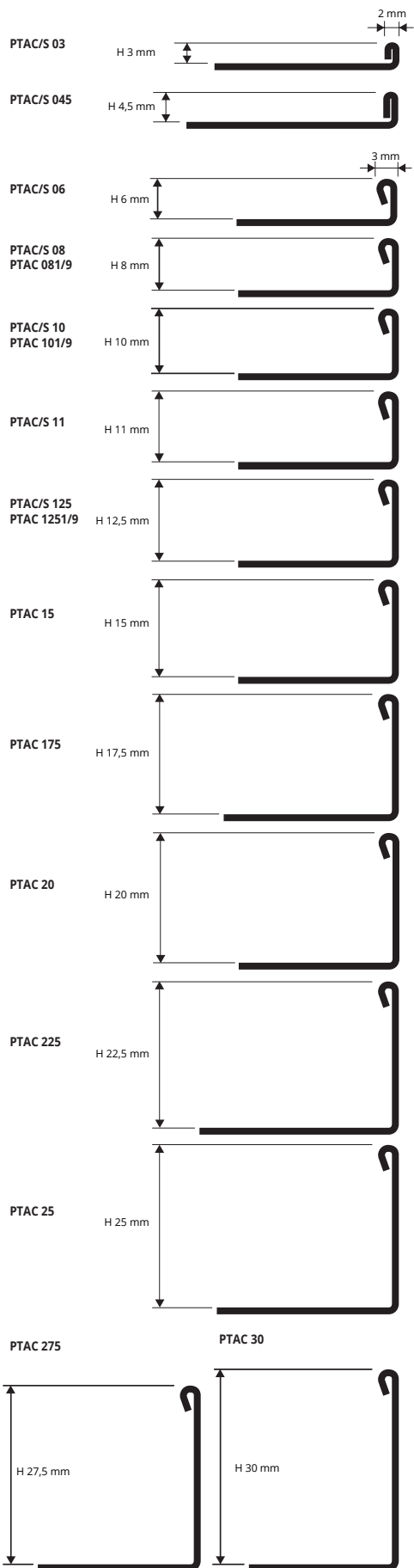

**POLISHED STAINLESS ST. AISI 304/1.4301-V2A with protective film**  
bar length 2,7 lm - pack. 40 Pcs - 108 lm - 10/10 mm  
(H 15 to H 30 mm - pack. 20 Pcs - 54 lm)

Article	H mm		
PTAC 03	3		
PTAC 045	4,5		
PTAC 06	6		
PTAC 08	8		
PTAC 10	10		
PTAC 11	11		
PTAC 125	12,5		
PTAC 15	15		
PTAC 175	17,5		
PTAC 20	20		
PTAC 225	22,5		
PTAC 25	25		
PTAC 275	27,5		
PTAC 30	30		

**POLISHED STAINLESS ST. AISI 304/1.4301-V2A with protective film**  
bar length 1 lm - pack. 40 Pcs - 40 lm - 10/10 mm

Article	H mm		
PTAC 081	8		*
PTAC 101	10		**
PTAC 1251	12,5		**

**POLISHED STAINLESS ST. AISI 304/1.4301-V2A with protective film**  
bar length 0,9 lm - pack. 40 Pcs - 36 lm - 10/10 mm

Article	H mm		
PTAC 089	8		*
PTAC 109	10		**
PTAC 1259	12,5		**

**BRUSHED STAINLESS ST. AISI 304/1.4301-V2A with protective film**  
bar length 2,7 lm - pack. 40 Pcs - 108 lm - 10/10 mm  
(H 15 to H 30 mm - pack. 20 Pcs - 54 lm)

Article	H mm		
PTACS 03	3		
PTACS 045	4,5		
PTACS 06	6		
PTACS 08	8		
PTACS 10	10		
PTACS 11	11		
PTACS 125	12,5		
PTACS 15	15		
PTACS 20	20		

## COLOURS



## EXAMPLES AND INSTRUCTIONS FOR LAYING METHODS

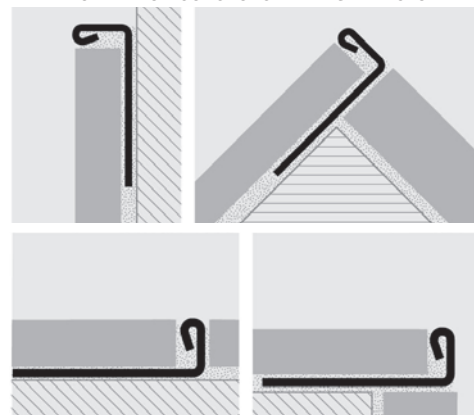

1. Choose the PROTERMINAL with the same height as the thickness of the covering. 2. Apply the adhesive onto the area of application of the profile. 3. Lay and align the profile pressing the perforated flange into the adhesive. 4. Lay the tiles, aligning them so that the top edge of the profile is "flush" with the tile. 5. Use the adhesive to seal any empty interstices.

SUITABLE FOR USE IN CONTACT WITH FOODSTUFFS.

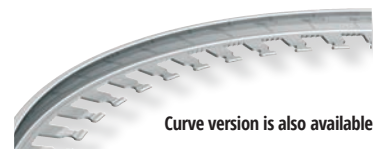

Curve version is also available

\* = Production on demand with minimum quantity of 100 pcs. Production delay 4/5 weeks. Price to be agreed



**PROTERMINAL** are manufactured with the same forms and sections, as well as in the very resistant material, the stainless shiny steel 316/1.4401-V4A, suitable for outdoors and marine environment with much presence of saltiness and considerable atmospheric agents. They are used as protection for the external angles of tiles, in order to separate or to create the separating joints in the pavements, to terminate the finishing of wall coverings, for platforms, stair steps, bathtubs, etc. They guarantee the impeccable work, ensuring considerable aesthetic effect as well. They strengthen the tile edge and prevents from chipping and breakages. Required by new European regulations on safety and accident prevention in public and private places.

# PROTERMINAL

POLISHED STAINLESS STEEL  
AISI 316/1.4404-V4A



**POLISHED STAINLESS ST. AISI 316L/1.4404-V4A**  
with protective film  
bar length 2,7 lm - pack. 40 Pcs - 108 lm - 10/10 mm



Article	H mm		
PTACM 06	6		
PTACM 08	8		
PTACM 10	10		
PTACM 125	12,5		

### EXAMPLES OF LAYING



### COLOURS



SUITABLE FOR USE IN CONTACT WITH FOODSTUFFS.

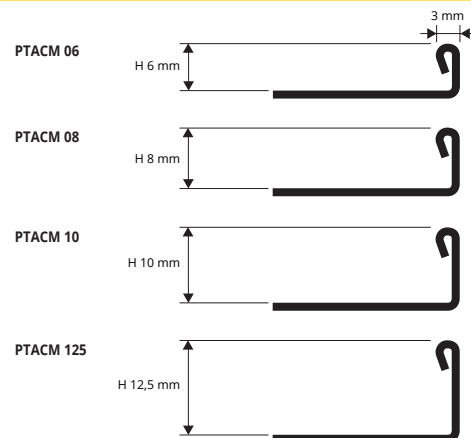

**PROTERMINAL** is a professional edging profile used mainly to join similar or different floor materials (e.g. tiles/tiles – tiles/parquet/marble/granite, etc.) of differing thickness.

**PROTERMINAL** in brass is also used to protect steps and decking, as a floor edging profile, to cover skirting, decking and worktops and to frame doormats.

# PROTERMINAL

POLISHED, NATURAL, ANTIQUE BRASS and  
BRUSHED



**POLISHED BRASS thermo packed**  
bar length 2,70 lm - pack. 20 Pcs 54 lm

Article	H mm		
PTOL 06	6		
PTOL 08	8		
PTOL 10	10		
PTOL 125	12,5		
PTOL 15	15		
PTOL 20	20		
PTOL 25	25		

**ANTIQUÉ BRASS thermo packed**  
bar length 2,70 lm - pack. 20 Pcs - 54 lm

Article	H mm		
PTOB 06	6		
PTOB 08	8		
PTOB 10	10		
PTOB 125	12,5		
PTOB 15	15		*
PTOB 20	20		*
PTOB 25	25		*

**BRUSHED BRASS thermo packed**  
bar length 2,70 lm - pack. 20 Pcs - 54 lm

Article	H mm		
PTOS 06	6		*
PTOS 08	8		*
PTOS 10	10		*
PTOS 125	12,5		*
PTOS 15	15		*
PTOS 20	20		*
PTOS 25	25		*

**NATURAL BRASS thermo packed**  
bar length 2,70 lm pack. 20 Pcs 54 lm (H 6 mm - 40 Pcs 108 lm)

Article	H mm		
PTON 06	6		
PTON 08	8		
PTON 10	10		
PTON 125	12,5		
PTON 15	15		
PTON 20	20		
PTON 25	25		

**NATURAL BRASS thermo packed**  
bar length 1 lm - pack. 40 Pcs - 40 lm

Article	H mm		
PTON 061	6		*
PTON 081	8		*
PTON 101	10		*
PTON 1251	12,5		*

**NATURAL BRASS thermo packed**  
bar length 0,90 lm - pack. 40 Pcs - 36 lm

Article	H mm		
PTON 069	6		*
PTON 089	8		*
PTON 109	10		*
PTON 1259	12,5		*



Curve version is also available

### COLOURS

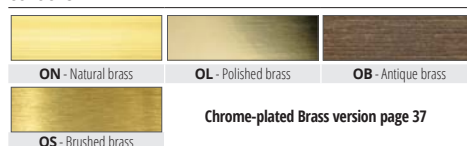

Chrome-plated Brass version page 37

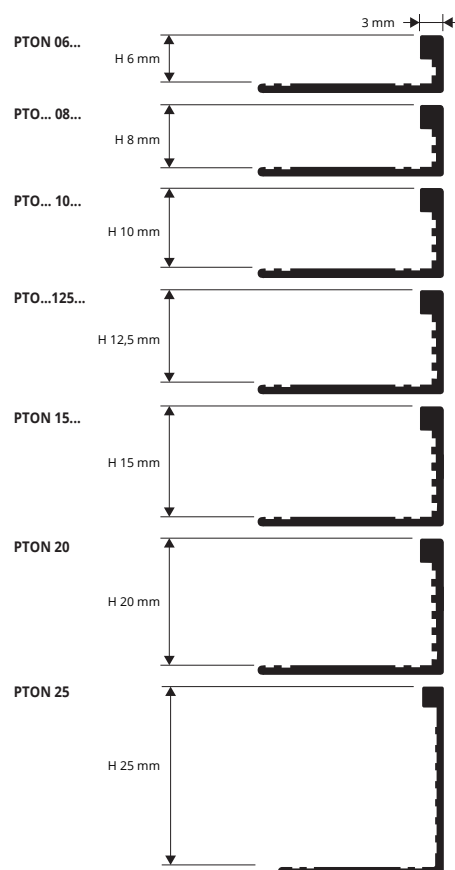

1. Choose the "PROTERMINAL" with the same height as the thickness of the floor/wall covering. 2. Apply the adhesive onto the area of application of the profile. 3. Lay and align the profile pressing the perforated flange into the adhesive. 4. Lay the tiles, aligning them so that the top edge of the profile is "flush" with the tile. Use the adhesive to seal any empty interstices. Oxidation marks may be easily removed by polishing the profiles with specific products to be found on sale such as Sidel, Smac and similar.

### EXAMPLES AND INSTRUCTIONS FOR LAYING METHODS

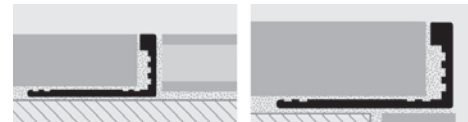

= News 2022

= Production on demand with minimum quantity of 100 pcs. Production delay 4/5 weeks. Price to be agreed

# PROTERMINAL

NATURAL ALUMINIUM AND ANODIZED SILVER ALUMINIUM

**PROTERMINAL** is a professional edging profile designed to protect and decorate the outside corners of tile, mosaic and marble coverings of differing thickness.

**PROTERMINAL** in aluminium is also used to join different floor materials and to protect steps and decking. Excellent as the edging trim skirtings and for bathroom and kitchen wall coverings. Match with PROLISTEL ALL strips in anodized aluminium with silver and polished chrome finish and with PROLISTEL ACC strips in AISI 304-1.4301 stainless steel with polished or brushed.

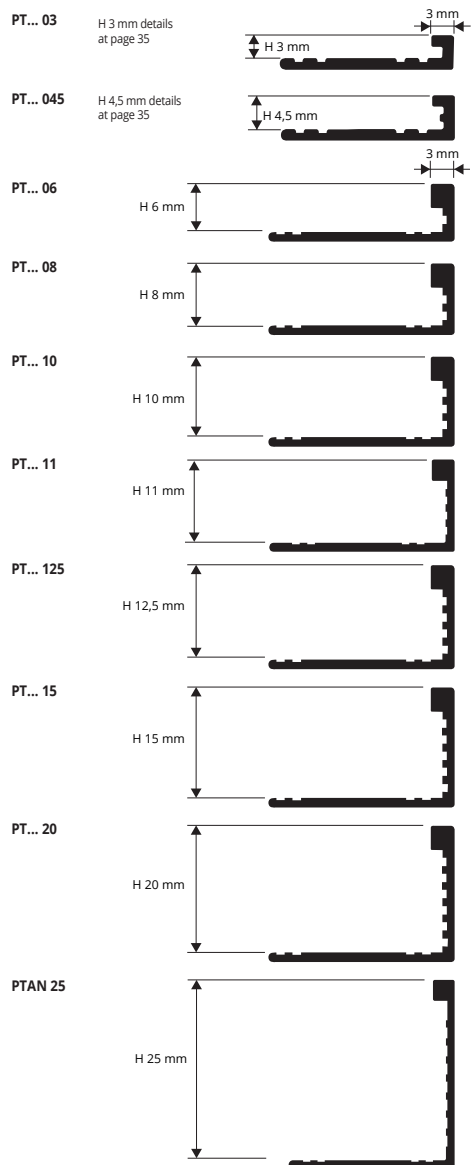

**NATURAL ALUMINIUM thermo packed 10 Pcs**  
bar length 2,70 lm - pack. 40 Pcs - 108 lm

Article	H mm		
PTAN 06	6		
PTAN 08	8		
PTAN 10	10		
PTAN 11	11		
PTAN 125	12,5		
PTAN 15	15		
PTAN 20	20		
PTAN 25	25		

**ANODIZED SILVER ALUMINIUM thermo packed**  
bar length 2,70 lm - pack. 40 Pcs - 108 lm

Article	H mm		
PTAA 06	6		
PTAA 08	8		
PTAA 10	10		
PTAA 11	11		
PTAA 125	12,5		
PTAA 15	15		
PTAA 20	20		

**NATURAL ALUMINIUM thermo packed 10 Pcs**  
bar length 0,90 lm - pack. 40 Pcs - 36 lm

Article	H mm		
PTAN 069	6		*
PTAN 089	8		*
PTAN 109	10		*
PTAN 1259	12,5		*

**NATURAL ALUMINIUM thermo packed 10 Pcs**  
bar length 1 lm - pack. 40 Pcs - 40 lm

Article	H mm		
PTAN 061	6		*
PTAN 081	8		*
PTAN 101	10		*
PTAN 1251	12,5		*

## COLOURS



Also available Polished version and curve version

## EXAMPLES AND INSTRUCTIONS FOR LAYING METHODS

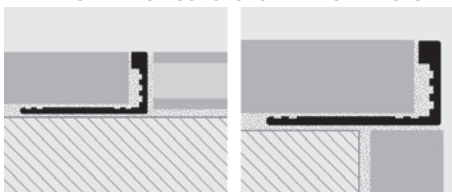

1. Choose the "PROTERMINAL" with the same height as the thickness of the covering. 2. Apply the adhesive onto the area of application of the profile. 3. Lay and align the profile pressing the perforated flange into the adhesive. 4. Lay the tiles, aligning them so that the top edge of the profile is "flush" with the tile. 5. Use the adhesive to seal any empty interstices.



\* = Production on demand with minimum quantity of 100 pcs. Production delay 4/5 weeks. Price to be agreed



**PROLEVIGAL** are separating profiles used to create the technical joint in the special types of pavements such as marble- Venice- palladium ones, that must be smoothed after their laying process. The particular "L" shape with the cut/drilled base and 2,5 mm thick vertical edge consent the perfect smoothing and constant thickness as well. Available in natural aluminium and natural brass, various thickness, as well in outlined/bent **PROLEVIGAL CURVES** BRASS versions.

# PROLEVIGAL

NATURAL BRASS



**NATURAL BRASS thermo packed 10 Pcs**  
bar length 2,7 lm - pack. 20 Pcs - 54 lm

Article	H mm		
PLGON 08	8		
PLGON 10	10		
PLGON 125	12,5		
PLGON 125/5	12,5		
PLGON 15	15		
PLGON 175	17,5		
PLGON 20	20		
PLGON 30	30		

## COLOURS

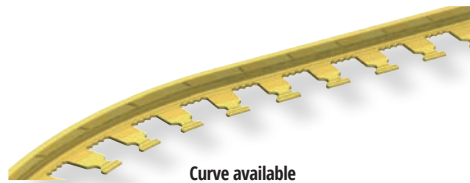

ADD **CV** AFTER THE ARTICLE CODE.  
E.g.: PLGON 08 (CURVE) PLGON**CV** 08

**AVAILABLE MINIMUM QUANTITY 200 PCS** by color and height



Price to be agreed. Production delay 4/5 weeks

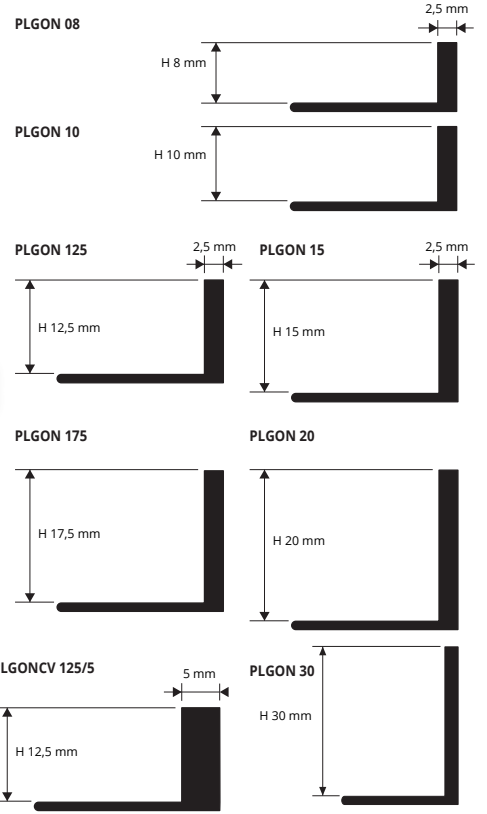

**PROLEVIGAL** are separating profiles used to create the technical joint in the special types of pavements such as marble- Venice- palladium ones, that must be smoothed after their laying process. The particular "L" shape with the cut/drilled base and 2,5 mm thick vertical edge consent the perfect smoothing and constant thickness as well. Available in natural aluminium and natural brass, various thickness, as well in outlined/bent **PROLEVIGAL CURVE** AL versions.

# PROLEVIGAL

NATURAL ALUMINIUM



**NATURAL ALUMINIUM thermo packed 10 Pcs**  
bar length 2,7 lm - pack. 40 Pcs - 108 lm

Article	H mm		
PLGAN 045	4,5		
PLGAN 06	6		
PLGAN 08	8		
PLGAN 10	10		
PLGAN 125	12,5		
PLGAN 15	15		
PLGAN 175	17,5		
PLGAN 20	20		

## COLOURS

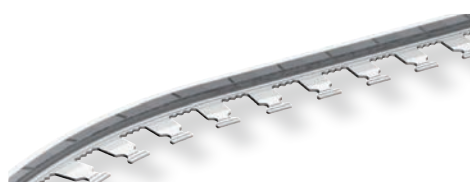

ADD **CV** AFTER THE ARTICLE CODE.  
E.g.: PLGAN 08 (CURVES) PLGAN**CV** 08

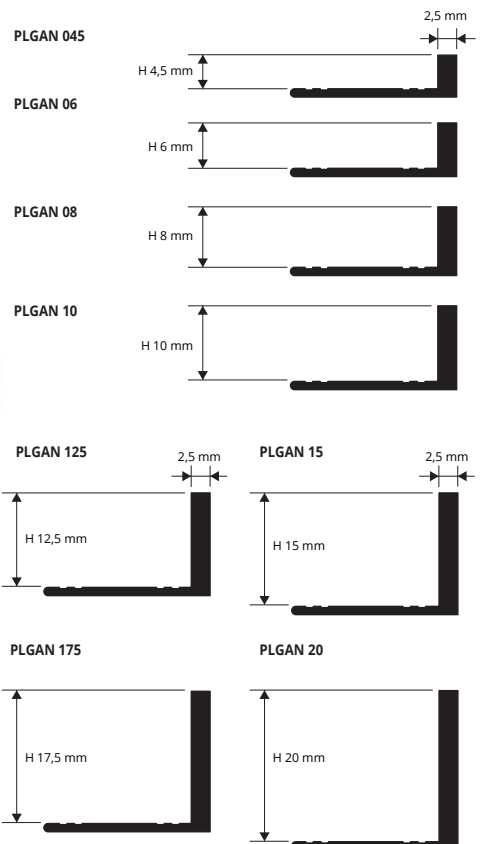

= News 2022

= Production on demand with minimum quantity of 200 pcs. Production delay 4/5 weeks. Price to be agreed



# PROELEGANT

NATURAL, POLISHED AND CHROMED BRASS

**PROELEGANT** is a refined profile, with 6 mm visible surface, designed to cover the joint between two types of floor covering, tiles - parquet, marble or granite, bestowing a prestige aesthetic effect that is ideal for indoor and outdoor finishes, even when subject to considerable loads. **PROELEGANT** is available in polished, natural and chromed brass. It is available in various heights in order to satisfy all technical, practical and, in particular, decorative requirements. The chromed version may be used as a decorative strip in the wall covering.

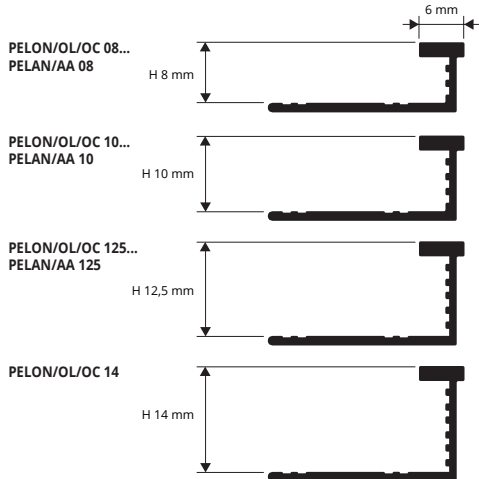

### EXAMPLES AND INSTRUCTIONS FOR LAYING METHODS

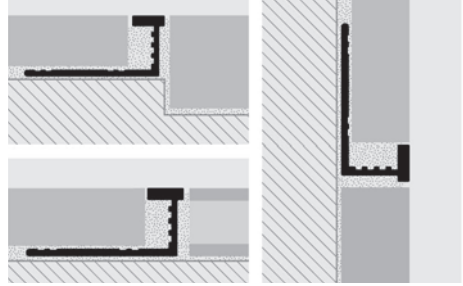

1. Choose the "PROELEGANT" with the same height as the thickness of the wall covering/floor. 2. Apply the adhesive onto the area of application of the profile. 3. Lay and align the profile pressing the perforated flange into the adhesive. 4. Lay the tiles, aligning them so that the top edge of the profile is "flush" with the tile. 5. Use the adhesive to seal any empty interstices. Oxidation marks may be easily removed by polishing the profiles with specific products to be found on sale such as Sidel, Smac and similar.

**POLISHED BRASS thermo packed**  
bar length 2,7 lm - pack. 20 Pcs - 54 lm

Article	H mm		
PELOL 08	8		
PELOL 10	10		
PELOL 125	12,5		
PELOL 14	14		

**CHROMED BRASS thermo packed**  
bar length 2,7 lm - pack. 20 Pcs - 54 lm

Article	H mm		
PELOC 08	8		
PELOC 10	10		
PELOC 125	12,5		
PELOC 14	14		

**NATURAL BRASS thermo packed 10 Pcs**  
bar length 2,7 lm - pack. 20 Pcs - 54 lm

Article	H mm		
PELON 08	8		
PELON 10	10		
PELON 125	12,5		
PELON 14	14		

**NATURAL BRASS thermo packed 5 Pcs**  
bar length 0,90 lm - pack. 40 Pcs - 36 lm

Article	H mm		
PELON 089	8		*
PELON 109	10		*
PELON 1259	12,5		*

### COLOURS



# PROELEGANT

NATURAL ALUMINIUM AND ANODIZED SILVER ALUMINIUM

**PROELEGANT** is a refined profile, with 6 mm visible surface, designed to cover the joint between two types of floor covering, tiles - parquet, marble or granite, bestowing a prestige aesthetic effect that is ideal for indoor and outdoor finishes, even when subject to considerable loads. **PROELEGANT** is available in natural and anodized silver aluminium. It is available in various heights in order to satisfy all technical, practical and, in particular, decorative requirements. The anodized version may be used as a decorative strip in the wall covering.

### EXAMPLES OF LAYING (for instructions see the product above)

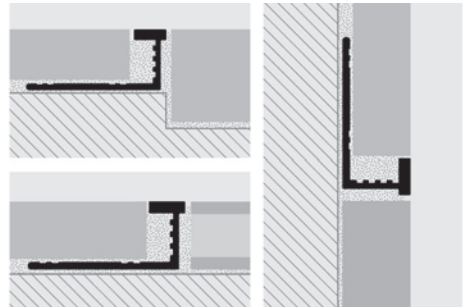

**NATURAL ALUMINIUM thermo packed 10 Pcs**  
bar length 2,7 lm - pack. 40 Pcs - 108 lm

Article	H mm		
PELAN 08	8		
PELAN 10	10		
PELAN 125	12,5		

**ANODIZED SILVER ALUMINIUM thermo packed**  
bar length 2,7 lm - pack. 40 Pcs - 108 lm

Article	H mm		
PELAA 08	8		
PELAA 10	10		
PELAA 125	12,5		

### COLOURS

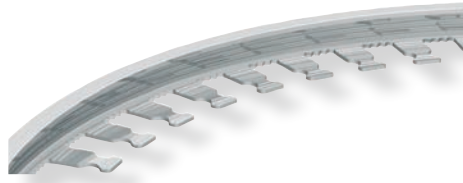

Curve available, see page 103

\* = Production on demand with minimum quantity of 100 pcs. Production delay 4/5 weeks. Price to be agreed







# PROFINAL

POLISHED, BRUSHED AND SANDED  
STAINLESS STEEL AISI 304/1.4301-V2A

**PROFINAL** is a profile in stainless steel AISI 304/1.4301-V2A polished, brushed and sanded. It is available in three widths 8, 10 and 12.5 mm. Ideal for joining two types of floor on the same level (e.g. tile/tile or tile/wood), creating a decorative separating profile. It is also suitable as a step nosing or to create a decorative strip in the covering. It protects the edge and withstands high loads and frequent traffic.

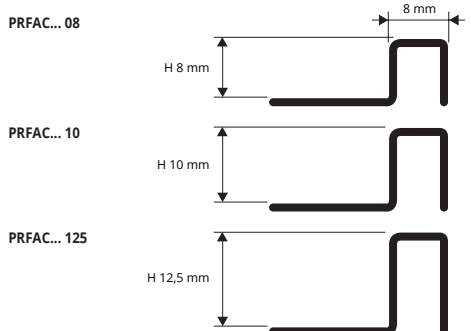

### EXAMPLES AND INSTRUCTIONS FOR LAYING METHODS

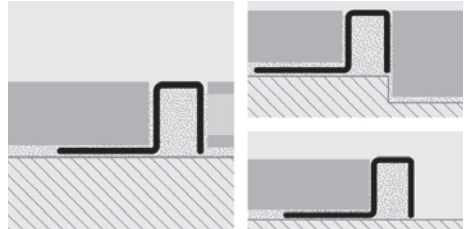

1. Choose the "PROFINAL" with the same height as the thickness of the covering. 2. Apply the adhesive onto the area of application of the profile. 3. Lay and align the profile pressing the perforated flange into the adhesive. 4. Lay the tiles, aligning them so that the top edge of the profile is "flush" with the tile. 5. Use the adhesive to seal any empty interstices.

**POLISHED STAINLESS ST. AISI 304/1.4301-V2A with protective film**  
bar length 2,7 lm - pack. 20 Pcs - 54 lm - 10/10 mm

Article	H mm
PRFAC 08	8
PRFAC 10	10
PRFAC 125	12,5

**BRUSHED STAINLESS ST. AISI 304/1.4301-V2A with protective film**  
bar length 2,7 lm - pack. 20 Pcs - 54 lm - 10/10 mm

Article	H mm
PRFACS 08	8
PRFACS 10	10
PRFACS 125	12,5

### COLOURS



**SANDED STAINLESS STEEL AISI 304/1.4301-V2A with protective film**  
bar length 2,7 lm - pack. 20 Pcs - 54 lm - 10/10 mm

Article	H mm
PRFACSB 08	8
PRFACSB 10	10
PRFACSB 125	12,5

SUITABLE FOR USE IN CONTACT WITH FOODSTUFFS.

# PROFINAL

NATURAL, POLISHED,  
CHROMED AND ANTIQUE BRASS

**PROFINAL** is a profile in natural, polished, chromed and antique brass. It is available in three widths 8, 10 and 12.5 mm. Ideal for joining two types of floor on the same level (e.g. tile/tile or tile/wood), creating a decorative separating profile. It is also suitable as a step nosing or to create a decorative strip in the covering. It protects the edge and withstands high loads and frequent traffic.

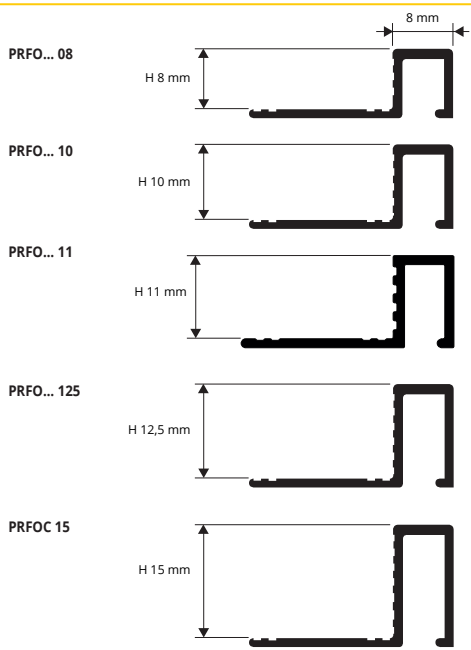

**NATURAL BRASS thermo packed 5 Pcs**  
bar length 2,7 lm - pack. 20 Pcs - 54 lm

Article	H mm
PRFON 08	8
PRFON 10	10
PRFON 125	12,5

**POLISHED BRASS thermo packed**  
bar length 2,7 lm - pack. 20 Pcs - 54 lm

Article	H mm
PRFOL 08	8
PRFOL 10	10
PRFOL 125	12,5

### COLOURS

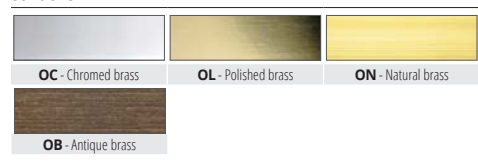

**CHROMED BRASS thermo packed**  
bar length 2,7 lm - pack. 20 Pcs - 54 lm (H 15 mm - 40,5 lm)

Article	H mm
PRFOC 08	8
PRFOC 10	10
PRFOC 11	11
PRFOC 125	12,5
PRFOC 15	15

### EXAMPLES AND INSTRUCTIONS FOR LAYING METHODS

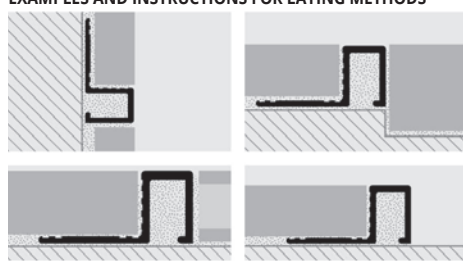

1. Choose the "PROFINAL" with the same height as the thickness of the covering. 2. Apply the adhesive onto the area of application of the profile. 3. Lay and align the profile pressing the perforated flange into the adhesive. 4. Lay the tiles, aligning them so that the top edge of the profile is "flush" with the tile. 5. Use the adhesive to seal any empty interstices. Oxidation products may be easily removed by polishing the profiles with specific products to be found on sale such as Sidol, Smac and similar.

**ANTIQUE BRASS thermo packed**  
bar length 2,7 lm - pack. 20 Pcs - 54 lm

Article	H mm
PRFOB 08	8
PRFOB 10	10
PRFOB 125	12,5

\* = Production on demand with minimum quantity of 100 pcs. Production delay 4/5 weeks. Price to be agreed

**PROFINAL** is a profile in natural and anodized silver aluminium. It is available in three widths 8, 10 and 12.5 mm. Ideal for joining two types of floor on the same level (e.g. tile/tile or tile/wood), creating a decorative separating profile. It is also suitable as a step nosing or to create a decorative strip in the covering. It protects the edge and withstands high loads and frequent traffic.

# PROFINAL

NATURAL ALUMINIUM AND ANODIZED SILVER ALUMINIUM



**NATURAL ALUMINIUM thermo packed** 10 Pcs  
bar length 2,7 lm - pack. 40 Pcs - 108 lm

Article	H mm
PRFAN 08	8
PRFAN 10	10
PRFAN 125	12,5

### COLOURS



**ANODIZED SILVER ALUMINIUM thermo packed**  
bar length 2,7 lm - pack. 40 Pcs - 108 lm

Article	H mm
PRFAA 08	8
PRFAA 10	10
PRFAA 125	12,5

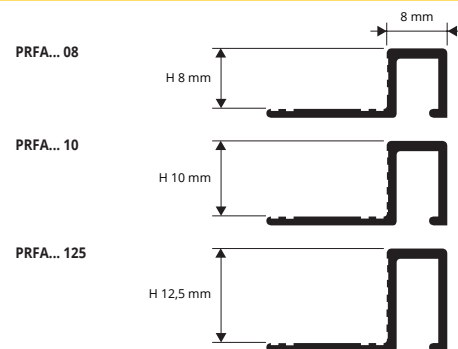

### EXAMPLES AND INSTRUCTIONS FOR LAYING METHODS

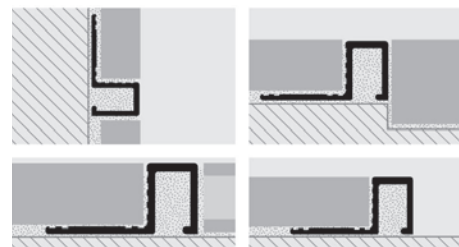

1. Choose the "PROFINAL" with the same height as the thickness of the covering.
2. Apply the adhesive onto the area of application of the profile.
3. Lay and align the profile pressing the perforated flange into the adhesive.
4. Lay the tiles, aligning them so that the top edge of the profile is "flush" with the tile.
5. Use the adhesive to seal any empty interstices. Oxidation marks may be easily removed by polishing the profiles with specific products to be found on sale such as Sidol, Smac and similar.



**NATURAL BRASS**  
bar length 3 lm - pack. 20 Pcs - 60 lm

Article	L x H mm
PQEON 108	10 X 8

### COLOURS



PQEON 108

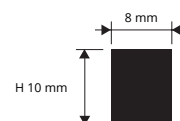

# PROSQUARE

NATURAL BRASS



**CHROMED, POLISHED BRASS thermo packed**  
bar length 2,7 lm - pack. 20 Pcs - 54 lm (PGAOC 10 : 27 lm)

Article	L x H mm
PGAOC 10	10 X 10
PGAOL 10	10 X 10



### COLOURS



PGAOL/OC 10

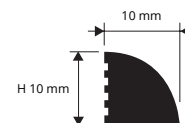

# PROANGLE

CHROMED, POLISHED BRASS

\* = Production on demand with minimum quantity of 100 pcs. Production delay 4/5 weeks. Price to be agreed

# PROJOINT

NATURAL AND POLISHED BRASS

**PROJOINT** is a brass profile for joining two floors at the same level. It can be laid with mortar or glue/adhesive. The head thickness allows perfect smoothing and sanding of over 3 mm. It is usually used for tile-wood-marble-Venetian-Palladian floors. Available in various heights and widths. The vertical arrowhead in the PIT 510 and PIT 514 version allows excellent anchorage with the adhesive.

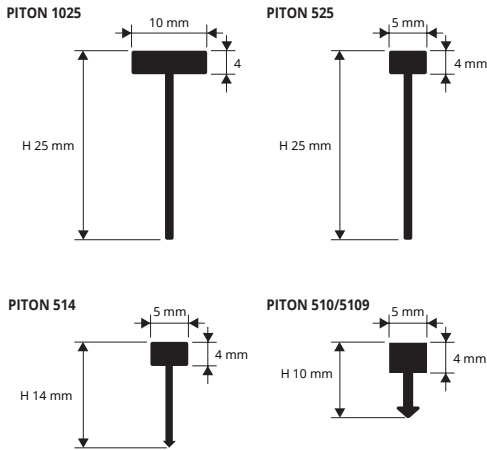

**POLISHABLE NATURAL BRASS**  
bar length 2,7 lm - pack. 20 Pcs - 54 lm

Article	L x H mm
PITON 1025	10 X 25
PITON 525	5 X 25
PITON 514	5 X 14
PITON 510	5 X 10

**POLISHABLE NATURAL BRASS**  
bar length 0,90 lm - pack. 40 Pcs

Article	L x H mm
PITON 5109	5 X 10

CONSISTING OF 1 ECOBLISTER WITH 2 PCS. OF 0.90 LM

**POLISHED BRASS**  
bar length 2,7 lm - pack. 20 Pcs - 54 lm

Article	L x H mm
PITON 1025	10 X 25
PITON 525	5 X 25
PITON 514	5 X 14
PITON 510	5 X 10

**POLISHED BRASS**  
bar length 0,90 lm - pack. 40 Pcs

Article	L x H mm
PITON 5109	5 X 10

CONSISTING OF 1 ECOBLISTER WITH 2 PCS. OF 0.90 LM

## EXAMPLES AND INSTRUCTIONS FOR LAYING METHODS

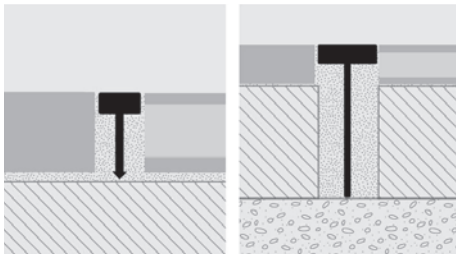

1. Choose "PROJOINT" according to the desired height.
  2. Cut "PROJOINT" to the desired length.
  3. Cut with a trowel the fresh screed following the floor edges.
  4. Apply the profile inside the fresh screed taking care to align it with the surface of the floor. After laying the joint should be 0,5 mm below the floor covering surface.
  5. Fill the joints between the profile and the tiles with grout, in order to avoid water stagnation. Remove immediately all grout remains from the profile surface.
- Mortar laying**
- Adhesive laying**
3. Apply the adhesive on the support where the profile will be laid. After laying the joint should be 0,5 mm below the floor covering surface.
  4. Lay the tiles aligning them with the profile leaving a 2 mm joint. Remove immediately all the remains of adhesive from the profile surface.
  5. Fill the joints between the profile and the tile with grout, in order to avoid water stagnation. Remove immediately all grout remains from the profile surface.

## COLOURS

ON DEMAND
ON - Natural brass
OL - Polished brass

# PROJOINT

NATURAL ALUMINIUM

**PROJOINT** is a natural aluminium profile for joining two floors at the same level. It can be laid with mortar or glue/adhesive. The head thickness allows perfect smoothing and sanding of over 3 mm. It is usually used for tile-wood-marble-Venetian-Palladian floors. Available in various heights and widths. The vertical arrowhead in the PIT 510 and PIT 514 version allows excellent anchorage with the adhesive.

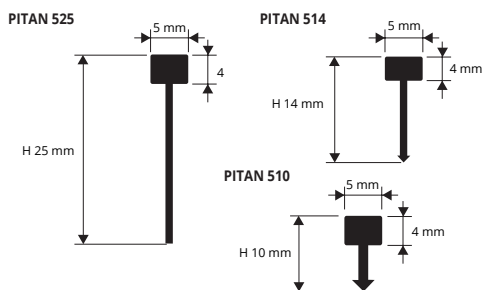

1. Choose "PROJOINT" according to the desired height.
  2. Cut "PROJOINT" to the desired length.
  3. Cut with a trowel the fresh screed following the floor edges.
  4. Apply the profile inside the fresh screed taking care to align it with the surface of the floor. After laying the joint should be 0,5 mm below the floor covering surface.
  5. Fill the joints between the profile and the tiles with grout, in order to avoid water stagnation. Remove immediately all grout remains from the profile surface.
- Mortar laying**
- Adhesive laying**
3. Apply the adhesive on the support where the profile will be laid. After laying the joint should be 0,5 mm below the floor covering surface.
  4. Lay the tiles aligning them with the profile leaving a 2 mm joint. Remove immediately all the remains of adhesive from the profile surface.
  5. Fill the joints between the profile and the tile with grout, in order to avoid water stagnation. Remove immediately all grout remains from the profile surface.

**NATURAL ALUMINIUM**  
bar length 2,70 lm - pack. 40 Pcs - 108 lm

Article	L x H mm
PITAN 525	5 X 25
PITAN 514	5 X 14
PITAN 510	5 X 10

## COLOURS

AN - Natural alum.
--------------------

## EXAMPLES AND INSTRUCTIONS FOR LAYING METHODS

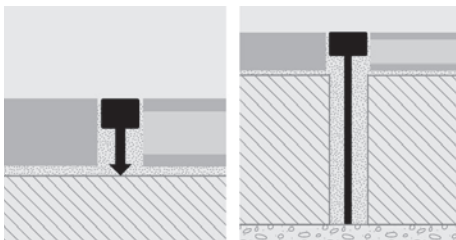

\* = Production on demand with minimum quantity of 100 pcs. Production delay 4/5 weeks. Price to be agreed

**PROCANAL** is a channel for joining floors and also for use as strips in wall coverings. This profile is made in natural, polished and chromed brass as well as natural or anodized silver aluminium. It is also used as a cable channel for the insertion of wires and conduits in all types of floor.

# PROCANAL

NATURAL, POLISHED,  
CHROMED, ANTIQUE AND BRUSHED BRASS  
NATURAL AND ANODIZED SILVER ALUMINIUM



**NATURAL BRASS thermo packed 10 Pcs - POLISHED, CHROMED, NATURAL, ANTIQUE AND BRUSHED BRASS thermo packed bar length 2,7 lm - pack. 40 Pcs - 108 lm (PCLOC 10 - 81 lm)**

Article	L x H mm
PCLON 10	10 X 10
PCLOL 10	10 X 10
PCLOC 10	10 X 10
PCLOB 10	10 X 10
PCLOS 10	10 X 10



**NATURAL ALUMINIUM thermo packed 10 Pcs ANODIZED SILVER ALUMINIUM thermo packed bar length 2,7 lm - pack. 40 Pcs - 108 lm**

Article	L x H mm
PCLAN 10	10 X 10
PCLAA 10	10 X 10

Available Stainless steel AISI 304/1.4301-V2A "PROLISTEL" 10x10 PLTAC 10 / PLTACS 10

## COLOURS

AN - Natural alum.	AA - Anodized silver alum.
--------------------	----------------------------

## COLOURS

ON - Natural brass	OL - Polished brass	OC - Chromed brass
OB - Antique Brass	OS - Brushed brass	

PCL... 10

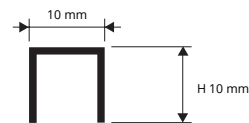

## EXAMPLES AND INSTRUCTIONS FOR LAYING METHODS

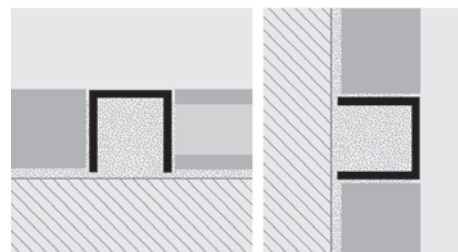

1. Choose the profile in the required material and finish. 2. Apply the adhesive onto the area of application. 3. Lay the "PROCANAL". 4. Continue laying by aligning it "flush" with the covering. 5. Use the adhesive to seal any empty interstices. Oxidation marks may be easily removed by polishing the profiles with specific products to be found on sale such as Sidol, Smac and similar.

**PROFLAT** is a range of 20 and 40 mm natural brass or steel strips 3 mm thick. Ideal for dividing up flooring on the same level, they may be polished in situ and also curved/shaped to create decorative patterns that are particularly recommended for marble, Palladian, Venetian and cement or resin-based floors.

# PROFLAT

STAINLESS STEEL AISI 304/1.4301-V2A  
NATURAL BRASS



**STAINLESS STEEL AISI 304/1.4301-V2A bar length 3 lm - pack. 5 Pcs - 15 lm**

Article	L x H mm
GPLAC 2033	3 X 20
GPLAC 4033	3 X 40

**STAINLESS STEEL AISI 304/1.4301-V2A bar length 3 lm - pack. 5 Pcs - 15 lm**

Article	L x H mm
GPLAC 2053	5 X 20
GPLAC 5053	5 X 50

SUITABLE FOR USE IN CONTACT WITH FOODSTUFFS.  
Available ON REQUEST IN Brushed Stainless steel



**POLISHABLE NATURAL BRASS bar length 2,7 lm - pack. 5 Pcs - 13,5 lm**

Article	L x H mm
GPLON 2025	2,5 X 20
GPLON 4025	2,5 X 40

## COLOURS

AC - Stainless steel AISI 304/1.4301-V2A	ON - Natural brass
--	--------------------

1. Choose "PROFLAT" according to the desired height and visible surface. 2. Cut "PROFLAT" to the desired length. 3. Cut with a trowel the fresh screed following the floor edges. 4. Apply the profile inside the fresh screed taking care to align it with the surface of the floor. After laying the joint should be 0,5 mm below the floor covering surface. 5. Fill the joints between the profile and the tiles with grout, in order to avoid water stagnation. Remove immediately all grout remains from the profile surface.

GPLAC 203../ 205..

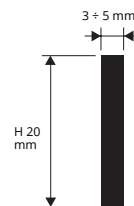

GPLON 2025

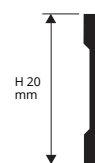

GPLAC 403../ 505..

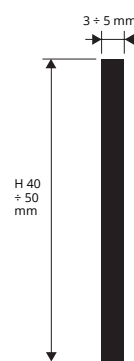

GPLON 4025

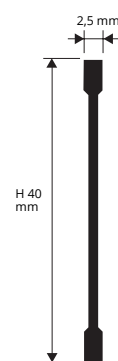

## EXAMPLES AND INSTRUCTIONS FOR LAYING METHODS

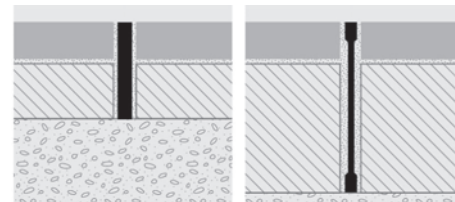



# PROSLIDER

POLISHED AND BRUSHED  
STAINLESS STEEL AISI 304/1.4301-V2A

**PROSLIDER** is a sloping terminal transition profile in stainless steel AISI 304/1.4301-V2A designed to join different height floors in a perfect, stepless way. This particularly sturdy profile with the bent base sloping inwards withstands and supports high loads and frequent passage of manual trolleys and vehicles in addition to protecting the edge of the higher floor. **PROSLIDER** is used in particular to join tile or wood to an existing floor. Available in polished and brushed stainless steel in various heights to accommodate all differences in level.

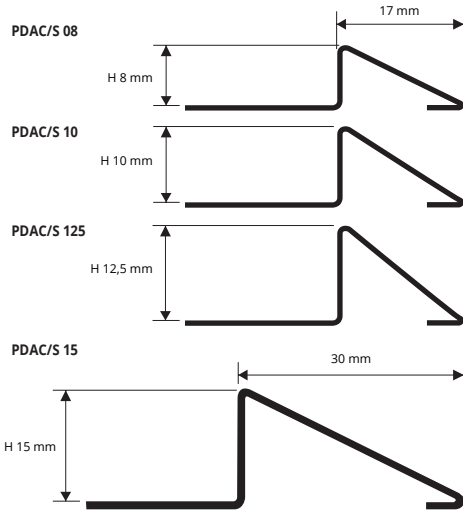

**POLISHED STAINLESS ST. AISI 304/1.4301-V2A with protective film**  
bar length 2,7 lm - pack. 20 Pcs - 54 lm - 10/10 mm

Article	H mm		
PDAC 08	8		
PDAC 10	10		
PDAC 125	12,5		
PDAC 15	15		
PDAC 20	20		



**BRUSHED STAINLESS ST. AISI 304/1.4301-V2A with protective film**  
bar length 2,7 lm - pack. 20 Pcs - 54 lm - 10/10 mm

Article	H mm		
PDACS 08	8		
PDACS 10	10		
PDACS 125	12,5		
PDACS 15	15		
PDACS 20	20		

SUITABLE FOR USE IN CONTACT WITH FOODSTUFFS.

1. Choose the profile with the required height and finish.
2. Fill the profile cavity with adhesive and apply the adhesive onto the area of application.
3. Lay the "PROSLIDER".
4. Align it "flush" with the floor/covering.
5. Use the adhesive to seal any empty interstices.

### COLOURS

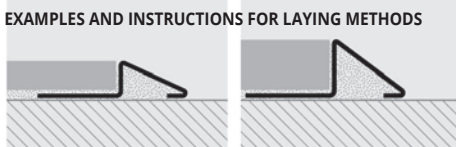

# PROSLIDER

POLISHED AND NATURAL BRASS

**PROSLIDER** is a sloping terminal transition profile designed to join different height floors in a perfect, stepless way. This particularly sturdy profile withstands and supports high loads and frequent passage of manual trolleys and vehicles in addition to protecting the edge of the higher floor. **PROSLIDER** is used in particular to join tile or wood to an existing floor. Available in natural and polished brass in various heights to accommodate all differences in level.

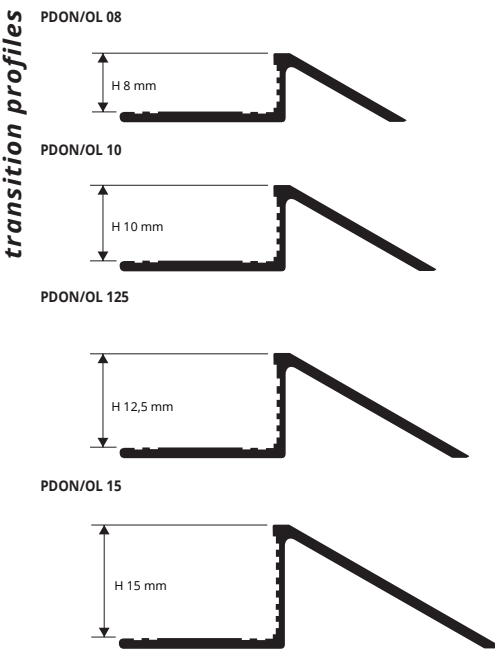

**NATURAL BRASS thermo packed 5 Pcs**  
bar length 2,7 lm - pack. 20 Pcs - 54 lm

Article	H mm		
PDON 08	8		*
PDON 10	10		
PDON 125	12,5		*
PDON 15	15		*



**POLISHED BRASS thermo packed**  
bar length 2,7 lm - pack. 20 Pcs - 54 lm

Article	H mm		
PDOL 08	8		*
PDOL 10	10		
PDOL 125	12,5		*
PDOL 15	15		*

### INSTRUCTIONS FOR LAYING

1. Choose the profile with the required height H, material and finish.
  2. Fill the profile cavity with adhesive and apply the adhesive onto the area of application.
  3. Lay the "PROSLIDER".
  4. Align it "flush" with the floor/covering.
  5. Use the adhesive to seal any empty interstices.
- Oxidation marks on profiles in natural and polished brass may be easily removed by polishing the profiles with specific products to be found on sale such as Sidol, Smac and similar.

### COLOURS

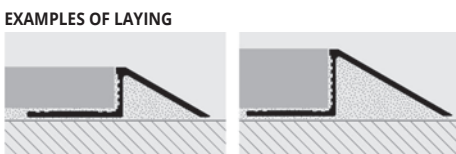

\* = Production on demand with minimum quantity of 100 pcs. Production delay 4/5 weeks. Price to be agreed

**PROSLIDER** is a sloping terminal transition profile designed to join different height floors in a perfect, stepless way. This particularly sturdy profile withstands and supports high loads and frequent passage of manual trolleys and vehicles in addition to protecting the edge of the higher floor. **PROSLIDER** is used in particular to join tile or wood to an existing floor.

Available in natural and anodized silver aluminium in various heights to accommodate all differences in level.

## PROSLIDER

NATURAL ALUMINIUM AND ANODIZED SILVER ALUMINIUM



**NATURAL ALUMINIUM thermo packed 5 Pcs**  
bar length 2,7 lm - pack. 40 Pcs - 108 lm

Article	H mm
PDAN 08	8
PDAN 10	10
PDAN 125	12,5

**ANODIZED SILVER ALUMINIUM thermo packed**  
bar length 2,7 lm - pack. 40 Pcs - 108 lm

Article	H mm
PDAA 08	8
PDAA 10	10
PDAA 125	12,5

### COLOURS

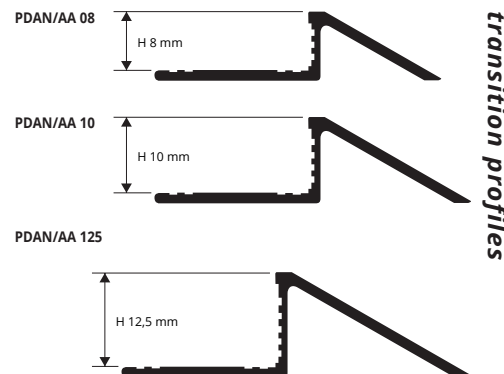

### EXAMPLES AND INSTRUCTIONS FOR LAYING METHODS

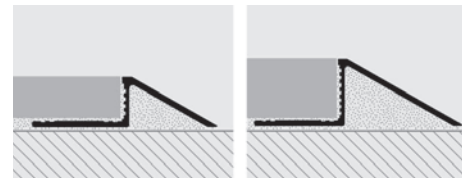

1. Choose the profile with the required height H, material and finish. 2. Fill the profile cavity with adhesive and apply the adhesive onto the area of application. 3. Lay the "PROSLIDER". 4. Align it "flush" with the floor/covering. 5. Use the adhesive to seal any empty interstices.

**PROSLIDER LR** is a sloping terminal transition profile designed to join different height floors in a perfect, stepless way. This particularly sturdy profile withstands and supports high loads and frequent passage of manual trolleys and vehicles in addition to protecting the edge of the higher floor. **PROSLIDER LR** is used in particular to join tile or wood to an existing floor.

Available in natural and anodized silver aluminium in various heights to accommodate all differences in level.

## PROSLIDER LR

NATURAL ALUMINIUM AND ANODIZED SILVER ALUMINIUM

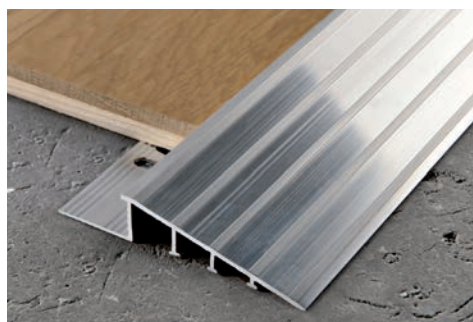

**NATURAL ALUMINIUM thermo packed 5 Pcs**  
bar length 2,7 lm - pack. 20 Pcs - 54 lm

Article	H mm
PDLRAN 10	10
PDLRAN 125	12,5
PDLRAN 15	15
PDLRAN 20	20

**ANODIZED SILVER ALUMINIUM thermo packed**  
bar length 2,7 lm - pack. 20 Pcs - 54 lm

Article	H mm
PDLRAA 10	10
PDLRAA 125	12,5
PDLRAA 15	15
PDLRAA 20	20

### COLOURS

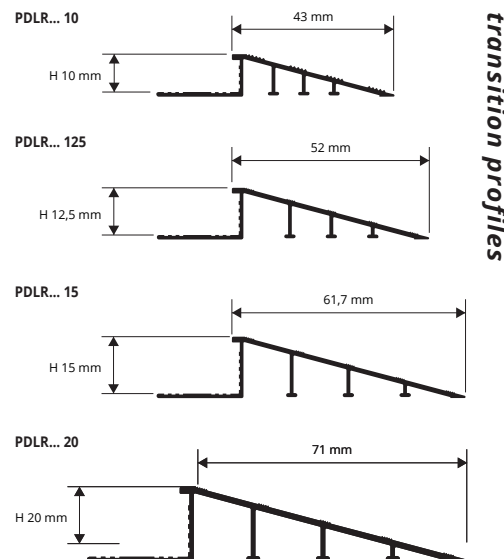

### INSTRUCTIONS FOR LAYING

1. Choose the profile with the required height H, material and finish. 2. Fill the profile cavity with adhesive and apply the adhesive onto the area of application. 3. Lay the "PROSLIDER LR". 4. Align it "flush" with the floor/covering. 5. Use the adhesive to seal any empty interstices.

### EXAMPLES OF LAYING

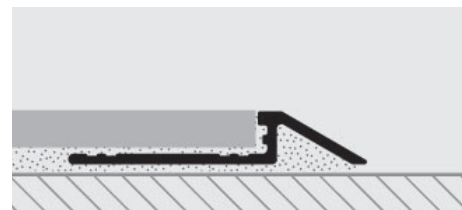



# PROSLIDER WOOD

NATURAL OAK WITH ALUMINIUM BASE

**PROSLIDER WOOD** is a sloping terminal transition profile in real natural oak with glued-on, punched aluminium base, designed to join different height floors in a perfect, stepless way. This particularly sturdy profile withstands and supports high loads and frequent passage of manual trolleys and vehicles in addition to protecting the edge of the higher floor. Available in various heights to accommodate all differences in level.

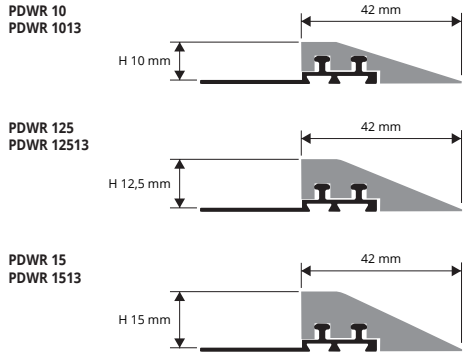

**NATURAL OAK with ALUMINIUM BASE**  
bar length 2,7 lm - pack. 10 Pcs - 27 lm

Article	H mm		
PDWR 10	10		
PDWR 125	12,5		
PDWR 15	15		

**NATURAL OAK with ALUMINIUM BASE**  
bar length 1,35 lm - pack. 20 Pcs - 27 lm

Article	H mm		
PDWR 1013	10		*
PDWR 12513	12,5		*
PDWR 1513	15		*

**EXAMPLES OF LAYING**

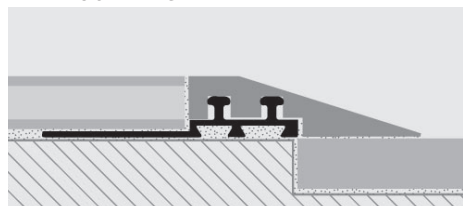

**INSTRUCTIONS FOR LAYING**

1. Choose the "PROSLIDER WOOD" with the required height.
2. Apply the adhesive onto the area of application of the profile.
3. Lay and align the profile pressing the perforated flange into the adhesive.
4. Align it "flush" with the floor/covering.
5. Use the adhesive to seal any empty interstices.

**COLOURS**





**PROCARPET ACC** is a profile in stainless steel 304/1.4301-V2A used for joining two floors of differing thickness and in particular for joining a tiled or parquet floor to wall-to-wall carpeting, making a perfect join thanks to the vertical part of less than 4 mm. In addition to completely protecting the edge of the higher floor, this particularly sturdy profile withstands high loads and supports the frequent passage of manual trolleys, vehicles and intense pedestrian traffic.

## PROCARPET ACC

STAINLESS STEEL AISI 304/1.4301-V2A



**POLISHED STAINLESS ST. AISI 304/1.4301-V2A** with protective film  
bar length 2,7 lm - pack. 20 Pcs - 54 lm - 10/10 mm

Article	H mm
PRTAC 08	8
PRTAC 10	10
PRTAC 125	12,5

**BRUSHED STAINLESS ST. AISI 304/1.4301-V2A** with protective film  
bar length 2,7 lm - pack. 20 Pcs - 54 lm - 10/10 mm

Article	H mm
PRTACS 08	8
PRTACS 10	10
PRTACS 125	12,5

### COLOURS



AC - Polished stainless steel AISI 304/1.4301-V2A  
ACS - Brushed stainless steel AISI 304/1.4301-V2A

### INSTRUCTIONS FOR LAYING

1. Choose the "PROCARPET ACC" taking into consideration the exact height of the floor. 2. Using a notched spreader apply the adhesive onto the area of application of the profile. 3. Lay and align the profile, cut to the necessary length, pressing the perforated flange into the adhesive. 4. Lay the tiles, aligning them so that the top edge of the profile is "flush" with the tile. 5. Fill the profile/tile area of contact with adhesive to prevent the accumulation of water in any voids.

SUITABLE FOR USE IN CONTACT WITH FOODSTUFFS.

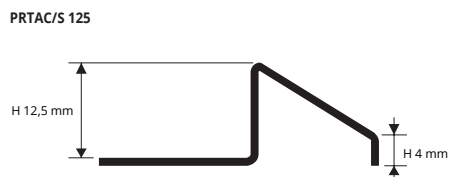
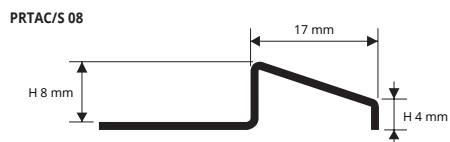

transition profiles

### EXAMPLES OF LAYING

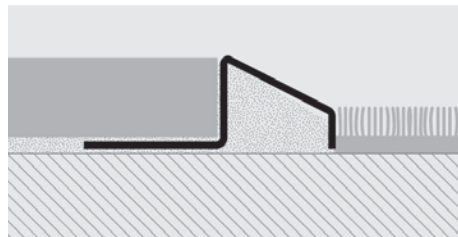

**PROCARPET OTT** is a profile in brass (natural or polished) used for joining two floors of differing thickness and in particular for joining a tiled or parquet floor to wall-to-wall carpeting, making a perfect join thanks to the vertical part of less than 4 mm. In addition to completely protecting the edge of the higher floor, this particularly sturdy profile withstands high loads and supports the frequent passage of manual trolleys, vehicles and intense pedestrian traffic.

## PROCARPET OTT

POLISHED AND NATURAL BRASS



**NATURAL BRASS thermo packed** 5 Pcs  
bar length 2,7 lm - pack. 20 Pcs - 54 lm

Article	H mm
PRTON 08	8
PRTON 10	10

**POLISHED BRASS thermo packed**  
bar length 2,7 lm - pack. 20 Pcs - 54 lm

Article	H mm
PRTOL 08	8
PRTOL 10	10

### COLOURS

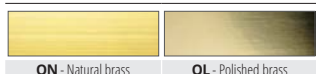

ON - Natural brass  
OL - Polished brass

### INSTRUCTIONS FOR LAYING

1. Choose the "PROCARPET OTT" taking into consideration the exact height of the floor. 2. Using a notched spreader apply the adhesive onto the area of application of the profile. 3. Lay and align the profile, cut to the necessary length, pressing the perforated flange into the adhesive. 4. Lay the tiles, aligning them so that the top edge of the profile is "flush" with the tile. 5. Fill the profile/tile area of contact with adhesive to prevent the accumulation of water in any voids. Profiles in natural or polished brass may be subject to oxidation in environments with high degrees of humidity. Resulting marks may be easily removed by polishing the profiles with specific products to be found on sale such as Sidol, Smac and.

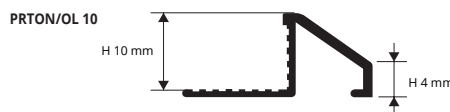
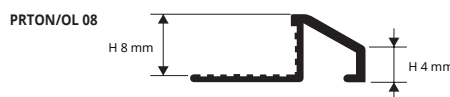

transition profiles

### EXAMPLES OF LAYING

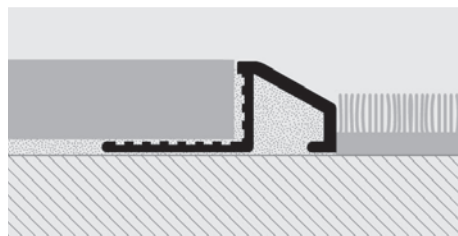



# PROCARPET ALL

NATURAL AND ANODIZED SILVER ALUMINIUM

**PROCARPET ALL** is a profile in aluminium (natural or silver anodized) used for joining two floors of differing thickness and in particular for joining a tiled or parquet floor to wall-to-wall carpeting, making a perfect join thanks to the vertical part of less than 4 mm. In addition to completely protecting the edge of the higher floor, this particularly sturdy profile withstands high loads and supports the frequent passage of manual trolleys, vehicles and intense pedestrian traffic.

transition profiles

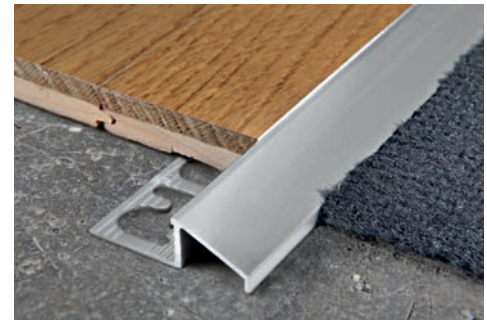
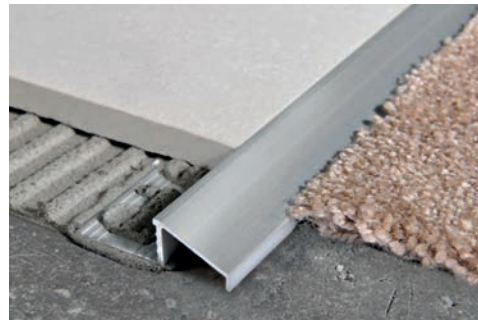
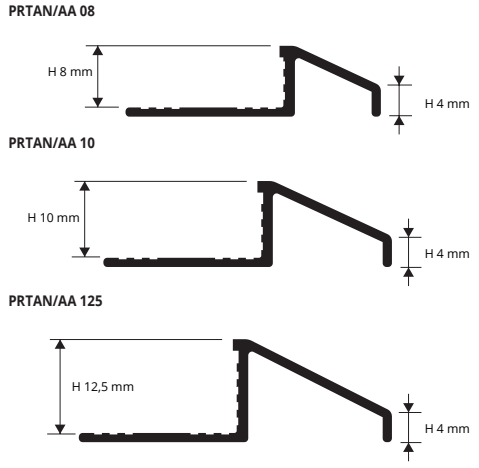

**NATURAL ALUMINIUM thermo packed 5 Pcs**  
bar length 2,70 lm - pack. 20 Pcs - 54 lm

Article	H mm		
PRTAN 08	8		
PRTAN 10	10		
PRTAN 125	12,5		

**ANODIZED SILVER ALUMINIUM thermo packed**  
bar length 2,70 lm - pack. 20 Pcs - 54 lm

Article	H mm		
PRTAA 08	8		
PRTAA 10	10		
PRTAA 125	12,5		

**EXAMPLES OF LAYING**

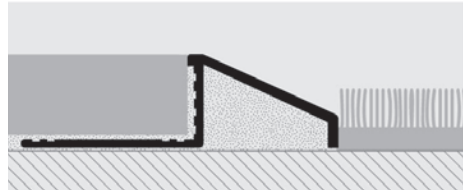

**INSTRUCTIONS FOR LAYING**

1. Choose the "PROCARPET ALL" taking into consideration the exact height of the floor.
2. Using a notched spreader apply the adhesive onto the area of application of the profile.
3. Lay and align the profile, cut to the necessary length, pressing the perforated flange into the adhesive.
4. Lay the tiles, aligning them so that the top edge of the profile is "flush" with the tile.
5. Fill the profile/tile area of contact with adhesive to prevent the accumulation of water in any voids.

**COLOURS**



# PROSKID

POLISHED BRASS AND ANODIZED SILVER ALUMINIUM

**PROSKID** is a sloping profile ideal for the stepless joining of two existing floors of differing heights where no transition profile was installed at the time of laying. Silicone is used for the laying. The notching on the profile helps anchorage of the silicone or adhesive. Hardwearing and attractive.

transition profiles

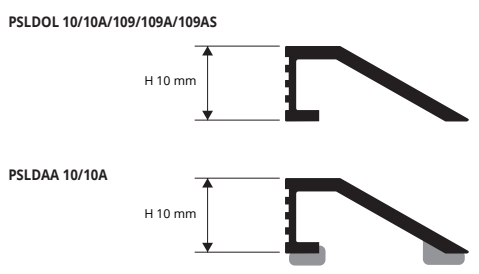

**POLISHED BRASS thermo packed**  
bar length 2,70 lm - pack. 20 Pcs - 54 lm

Article	H mm		
PSLDOL 10	10		
PSLDOL 10A	10		

"A" at the end of the product code = Item with adhesive

**ANODIZED SILVER ALUMINIUM thermo packed**  
bar length 2,70 lm - pack. 20 Pcs - 54 lm

Article	H mm		
PSLDAA 10	10		
PSLDAA 10A	10		

"A" at the end of the product code = Item with adhesive

**EXAMPLES AND INSTRUCTIONS FOR LAYING METHODS**

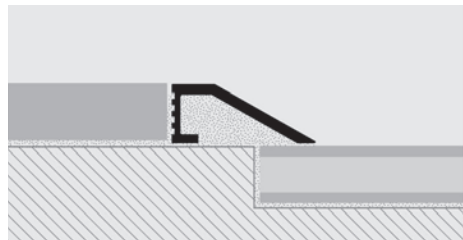

1. Choose the "PROCARPET" taking into consideration the exact height of the floor.
2. Using a notched spreader apply the adhesive onto the area of application of the profile.
3. Lay and align the profile, cut to the necessary length, pressing the perforated flange into the adhesive.
4. Lay the tiles, aligning them so that the top edge of the profile is "flush" with the tile.
5. Fill the profile/tile area of contact with adhesive to prevent the accumulation of water in any voids.

**POLISHED BRASS thermo packed**  
bar length 0,90 lm - pack. 20 Pcs



Article	H mm		
PSLDOL 109AS	10		

"AS" at the end of the product code = Item with adhesive

**POLISHED BRASS thermo packed**  
bar length 0,90 lm - pack. 20 Pcs



Article	H mm		
PSLDOL 109	10		
PSLDOL 109A	10		

"A" at the end of the product code = Item with adhesive

**COLOURS**





**PROLEVALL 29** is a transition profile in anodized aluminium available in the self-adhesive or punched versions. It is used to give a clean-cut, elegant finish when joining and compensating differences in level of floors that are already laid and in differing or same materials e.g. ceramic tiles-wood-parquet-marble, etc. It joins and compensates a thickness between 4 and 6mm. **PROLEVALL 29** ensures a perfect finish with little height, covering any flaws created during laying, while the contoured edges guarantee perfect adherence to the floor.

## PROLEVALL 29

ANODIZED ALUMINIUM WITH SELF-ADHESIVE AND PUNCHED



**ANODIZED ALUM. with adhesive thermo packed**  
bar length 2,7 lm - pack. 40 Pcs - 108 lm

Article	H x L mm
PLV... 29A	5,5 X 29

**ANODIZED ALUM. with adhesive thermo packed**  SELF PACK  
bar length 0,83 lm - pack. 20 Pc

Article	H x L mm
PLV... 298AS	5,5 X 29

**ANODIZED ALUM. with adhesive thermo packed**  SELF PACK  
bar length 0,93 lm - pack. 20 Pc

Article	H x L mm
PLV... 299AS	5,5 X 29

**ANODIZED ALUM. with adhesive thermo packed**  SELF PACK  
bar length 1,03 lm - pack. 20 Pc

Article	H x L mm
PLV... 2910AS	5,5 X 29

**ANODIZED ALUM. punched thermo packed**  
bar length 2,7 lm - pack. 40 Pcs - 108 lm

Article	H x L mm
PLV... 29F	5,5 X 29

**ANODIZED ALUM. punched with screws and screw anchors thermo packed** - bar length 0,83 lm - pack. 20 Pc  SELF PACK

Article	H x L mm
PLV... 298FS	5,5 X 29

**ANODIZED ALUM. punched with screws and screw anchors thermo packed** - bar length 0,93 lm - pack. 20 Pc  SELF PACK

Article	H x L mm
PLV... 299FS	5,5 X 29

**ANODIZED ALUM. punched with screws and screw anchors thermo packed** - bar length 1,03 lm - pack. 20 Pc  SELF PACK

Article	H x L mm
PLV... 2910FS	5,5 X 29

Available in the colours: AA - AO (AB, AT, CH e SB available on demand with a minimum quantity order of 100 pcs). The code of the selected colour must be added to the article code. E.g.: PLV... 29A (chosen colour anodized gold alum.) PLVAO 29A.

### COLOURS

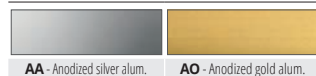

### AVAILABLE MINIMUM QUANTITY 100 PCS by color and height



(Price to be agreed. Production delay 4/5 weeks)

PLV... 29A  
PLV... 299AS  
PLV... 2910AS

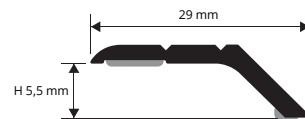

PLV... 29F  
PLV... 298FS  
PLV... 299FS  
PLV... 2910FS

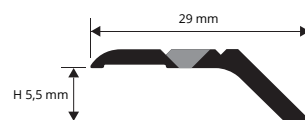

transition profiles

### EXAMPLES AND INSTRUCTIONS FOR LAYING METHODS

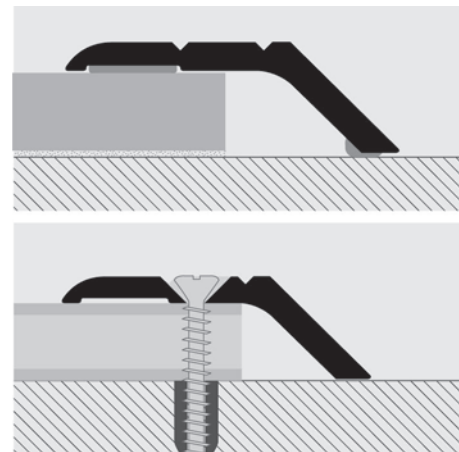

#### Adhesive version

1. Choose the suitable profile and cut it to the necessary length.
2. Degrease, wash and clean the solid surface thoroughly.
3. Remove the protective paper from the adhesive.
4. Lay the profile by applying pressure evenly over the whole surface without using a hammer.

#### Punched version

1. Choose the suitable profile and cut it to the necessary length.
2. Mark the position of the holes using the existing holes in the profile as reference.
3. Insert the screw anchors into the drilled holes.
4. Fix the profile using flathead screws suitable for the relative slots in the profile.

**PROLEVALL 33** is a transition profile in extruded polished brass, available in the self-adhesive or punched versions. It is used to give a clean-cut, elegant finish when joining and compensating differences in level of floors that are already laid and in differing or same materials e.g. ceramic tiles-wood-parquet-marble, etc. It joins and compensates a thickness between 4 and 6mm. **PROLEVALL 33** ensures a perfect finish with little height, covering any flaws created during laying, while the contoured edges guarantee perfect adherence to the floor.

## PROLEVALL 33

POLISHED BRASS WITH SELF-ADHESIVE AND PUNCHED

**POLISHED BRASS with adhesive thermo packed**  
bar length 2,7 lm - pack. 20 Pcs - 54 lm

Article	H x L mm
PLVOL 33A	5,5 X 33

**POLISHED BRASS with adhesive thermo packed**  SELF PACK  
bar length 0,83 lm - pack. 20 Pc

Article	H x L mm
PLVOL 338AS	5,5 X 33

**POLISHED BRASS with adhesive thermo packed**  SELF PACK  
bar length 0,93 lm - pack. 20 Pc

Article	H x L mm
PLVOL 339AS	5,5 X 33

**POLISHED BRASS with adhesive thermo packed**  SELF PACK  
bar length 1,03 lm - pack. 20 Pc

Article	H x L mm
PLVOL 3310AS	5,5 X 33

**POLISHED BRASS punched thermo packed**  
bar length 2,7 lm - pack. 20 Pcs - 54 lm

Article	H x L mm
PLVOL 33F	5,5 X 33

**POLISHED BRASS punched with screws and screw anchors thermo packed** - bar length 0,83 lm - pack. 20 Pc  SELF PACK

Article	H x L mm
PLVOL 338FS	5,5 X 33

**POLISHED BRASS punched with screws and screw anchors thermo packed** - bar length 0,93 lm - pack. 20 Pc  SELF PACK

Article	H x L mm
PLVOL 339FS	5,5 X 33

**POLISHED BRASS punched with screws and screw anchors thermo packed** - bar length 1,03 lm - pack. 20 Pc  SELF PACK

Article	H x L mm
PLVOL 3310FS	5,5 X 33

### COLOURS

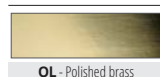

PLVOL 33A  
PLVOL 338AS  
PLVOL 339AS  
PLVOL 3310AS

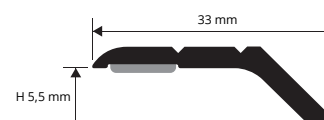

PLVOL 33F  
PLVOL 338FS  
PLVOL 339FS  
PLVOL 3310FS

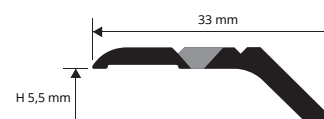

transition profiles

### EXAMPLES AND INSTRUCTIONS FOR LAYING METHODS



1. Choose the suitable profile and cut it to the necessary length.
2. Degrease, wash and clean the solid surface thoroughly.
3. Remove the protective paper from the adhesive.
4. Lay the profile by applying pressure evenly over the whole surface without using a hammer.

#### Punched version

2. Mark the position of the holes using the existing holes in the profile as reference.
3. Insert the screw anchors into the drilled holes.
4. Fix the profile using flathead screws suitable for the relative slots in the profile.

\* = Production on demand with minimum quantity of 100 pcs. Production delay 4/5 weeks. Price to be agreed



# PROLEVALL 305

POLISHED STAINLESS STEEL 1.4016 AND POLISHED BRASS WITH SELF-ADHESIVE AND PUNCHED

**PROLEVALL 305** is a transition/terminal profile for floors of medium thickness (from 3 to 7 mm), used to join and compensate two floors of differing height, material and thickness. Ideal as a finishing terminal, it covers flaws and chipping or splintering of tiles, wood and carpeting. Available in stainless steel 1.4016 and polished brass. A protective film protects the finish of the 2.70 m long bars with either self-adhesive backing or punched for fixing with screws and anchors. The 93 cm blister pack version (self pack) is shrink-wrapped with bar code.

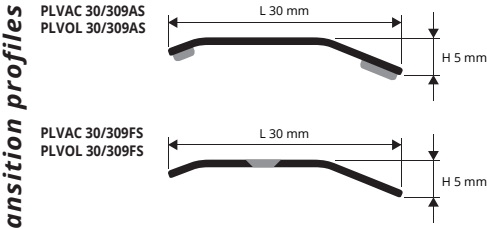

**POLISHED STAINLESS ST. 1.4016 with adhesive thermo packed**  
bar length 2,7 lm - pack. 40 Pcs - 108 lm

Article	H x L mm
PLVAC 30A	5 X 30

**POLISHED STAINLESS ST. 1.4016 punched with protective film**  
bar length 2,7 lm - pack. 40 Pcs - 108 lm

Article	H x L mm
PLVAC 30F	5 X 30

**POLISHED STAINLESS ST. 1.4016 with adhesive thermo packed - bar length 0,93 lm - pack. 20 Pc**

Article	H x L mm
PLVAC 309AS	5 X 30

**POL. STAINLESS ST. 1.4016 punched with screws and screw anchors thermo packed - bar length 0,93 lm - pack. 20 Pc**

Article	H x L mm
PLVAC 309FS	5 X 30

**POLISHED BRASS with adhesive thermo packed**  
bar length 2,7 lm - pack. 40 Pcs - 108 lm

Article	H x L mm
PLVOL 30A	5 X 30

**POLISHED BRASS punched with protective film**  
bar length 2,7 lm - pack. 40 Pcs - 108 lm

Article	H x L mm
PLVOL 30F	5 X 30

**POLISHED BRASS with adhesive thermo packed - bar length 0,93 lm - pack. 20 Pc**

Article	H x L mm
PLVOL 309AS	5 X 30

**POL. BRASS punched with screws and screw anchors thermo packed - bar length 0,93 lm - pack. 20 Pc**

Article	H x L mm
PLVOL 309FS	5 X 30

**COLOURS**

AC - Polished stainless steel 1.4016	OL - Polished brass

**ON DEMAND HAND-BRUSHED STAINLESS STEEL**  
(Price to be agreed. Production delay 4/5 weeks)

**EXAMPLES AND INSTRUCTIONS FOR LAYING METHODS**

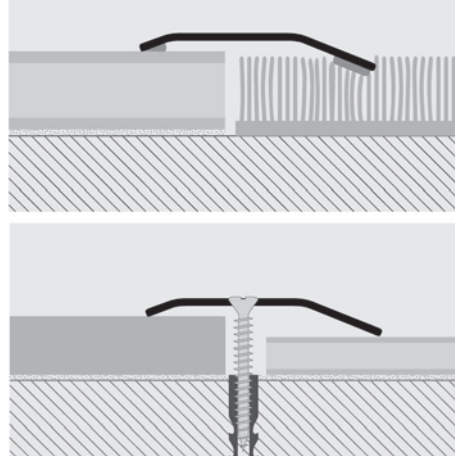

- Adhesive version**
1. Choose the suitable profile and cut it to the necessary length.
  2. Degrease, wash and clean the solid surface thoroughly.
  3. Remove the protective paper from the adhesive.
  4. Lay the profile by applying pressure evenly over the whole surface without using a hammer.
- Punched version**
1. Choose the suitable profile and cut it to the necessary length.
  2. Mark the position of the holes using the existing holes in the profile as reference.
  3. Insert the screw anchors into the drilled holes.
  4. Fix the profile using flathead screws suitable for the relative slots in the profile.

# PROLEVALL 32

ANODIZED ALUMINIUM WITH SELF-ADHESIVE AND PUNCHED

**PROLEVALL 32** are transition profiles in anodized aluminium available in the self-adhesive or punched versions. They are used to give a clean-cut, elegant finish when joining and compensating differences in level of floors that are already laid and in differing or same materials e.g. ceramic tiles-wood-parquet-marble, etc. They join and compensate a thickness between 7 and 9 mm. **PROLEVALL 32** ensures a perfect finish with little height, covering any flaws created during laying, while the contoured edges guarantee perfect adherence to the floor.

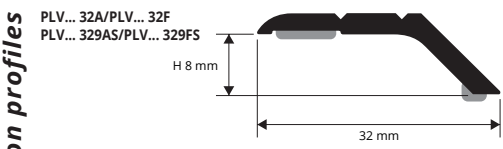

**ANODIZED SILVER and GOLD ALUMINIUM thermo packed - bar length 2,7 lm - pack. 40 Pcs - 108 lm**

Article	L x H mm
PLV... 32A	32 X 8
PLV... 32F	32 X 8

**ANODIZED SILVER and GOLD ALUMINIUM thermo packed - bar length 0,93 lm - pack. 20 Pc**

Article	L x H mm
PLV... 329AS	32 X 8
PLV... 329FS	32 X 8

"A" at the end of the product code = Item with adhesive  
"F" at the end of the product code = Punched Item

"AS" at the end of the product code = Item with adhesive  
"FS" at the end of the product code = Punched Item

Available in the colours: AA - AO (AB - AT, CH e SB available on demand with a minimum quantity order of 100 pcs). The code of the selected colour must be added to the article code. E.g.: PLV... 32F (chosen colour Anodized gold alum.) PLVAO 32F.

**COLOURS**

AA - Anodized silver alum.	AO - Anodized gold alum.

**AVAILABLE MINIMUM QUANTITY 100 PCS** by color and height

AB - Anodized bronze alum.	AT - Anodized titanium alum.	CH - Anod. champagne alum.	SB - Anodized sand alum.

(Price to be agreed. Production delay 4/5 weeks)

**EXAMPLES AND INSTRUCTIONS FOR LAYING METHODS**

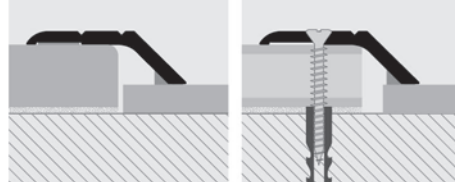

- Adhesive version**
1. Choose the suitable profile and cut it to the necessary length.
  2. Degrease, wash and clean the solid surface thoroughly.
  3. Remove the protective paper from the adhesive.
  4. Lay the profile by applying pressure evenly over the whole surface without using a hammer.
- Punched version**
1. Choose the suitable profile and cut it to the necessary length.
  2. Mark the position of the holes using the existing holes in the profile as reference.
  3. Insert the screw anchors into the drilled holes.
  4. Fix the profile using flathead screws suitable for the relative slots in the profile.

**\* = Production on demand with minimum quantity of 100 pcs. Production delay 4/5 weeks. Price to be agreed**

**PROLEVALL 358** are transition profiles in polished extruded brass, available in the self-adhesive or punched versions. They are used to give a clean-cut, elegant finish when joining and compensating differences in level of floors that are already laid and in differing or same materials e.g. ceramic tiles-wood-parquet-marble, etc. They join and compensate a thickness between 7 and 9 mm. **PROLEVALL 358** ensures a perfect finish with little height, covering any flaws created during laying, while the contoured edges guarantee perfect adherence to the floor.

## PROLEVALL 358

POLISHED BRASS  
WITH SELF-ADHESIVE AND PUNCHED



**POLISHED BRASS thermo packed** - bar length 2,7 lm  
pack. 20 Pcs - 54 lm (PLVOL 358F: 15 Pcs - 40,5 lm)

Article	L x H mm
PLVOL 358A	35 X 8
PLVOL 358F	35 X 8

"A" at the end of the product code = Item with adhesive  
"F" at the end of the product code = Punched Item

**POLISHED BRASS thermo packed**  
bar length 0,90 lm - pack. 20 Pcs



Article	L x H mm
PLVOL 3589AS	35 X 8
PLVOL 3589FS	35 X 8

"AS" at the end of the product code = Item with adhesive  
"FS" at the end of the product code = Punched Item

### COLOURS

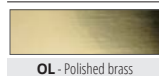

OL - Polished brass

PLVOL 358A/PLVOL 3589AS  
PLVOL 358F/PLVOL 3589FS

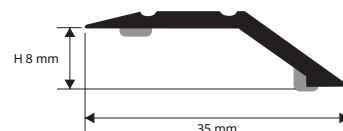

### EXAMPLES AND INSTRUCTIONS FOR LAYING METHODS

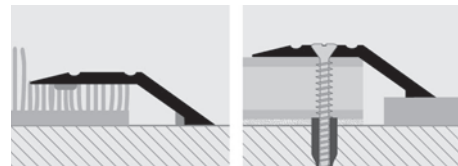

#### Adhesive version

1. Choose the suitable profile and cut it to the necessary length.
2. Degrease, wash and clean the solid surface thoroughly.
3. Remove the protective paper from the adhesive.
4. Lay the profile by applying pressure evenly over the whole surface without using a hammer.

#### Punched version

1. Choose the suitable profile and cut it to the necessary length.
2. Mark the position of the holes using the existing holes in the profile as reference.
3. Insert the screw anchors into the drilled holes.
4. Fix the profile using flathead screws suitable for the relative slots in the profile.

**PROLEVALL 4413** are transition profiles in polished extruded brass and anodized aluminium available in the self-adhesive or punched versions. They are used to give a clean-cut, elegant finish when joining and compensating differences in level of floors that are already laid and in differing or same materials e.g. ceramic tiles-wood-parquet-marble, etc. They join and compensate a thickness between 13 and 15 mm. **PROLEVALL 4413** ensures a perfect finish with little height, covering any flaws created during laying, while the contoured edges guarantee perfect adherence to the floor.

## PROLEVALL 4413

POLISHED BRASS AND  
ANODIZED SILVER ALUMINIUM  
WITH SELF-ADHESIVE AND PUNCHED



**POLISHED BRASS thermo packed**  
bar length 2,7 lm - pack. 10 Pcs - 27 lm

Article	L x H mm
PLVOL 4413A	44 X 13
PLVOL 4413F	44 X 13

"A" at the end of the product code = Item with adhesive  
"F" at the end of the product code = Punched Item

**ANODIZED SILVER and GOLD ALUMINIUM thermo packed**  
bar length 2,7 lm - pack. 20 Pcs - 54 lm

Article	L x H mm
PLV... 4413A	44 X 13
PLV... 4413F	44 X 13

"A" at the end of the product code = Item with adhesive  
"F" at the end of the product code = Punched Item

**POLISHED BRASS thermo packed**  
bar length 0,90 lm - pack. 20 Pcs



Article	L x H mm
PLVOL 44139AS	44 X 13
PLVOL 44139FS	44 X 13

"AS" at the end of the product code = Item with adhesive  
"FS" at the end of the product code = Punched Item

### COLOURS

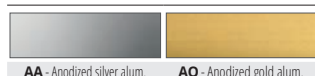

AA - Anodized silver alum. AO - Anodized gold alum.

### AVAILABLE MINIMUM QUANTITY 100 PCS by color and height



OL - Polished brass AT - Anodized titanium alum. CH - Anod. champagne alum. SB - Anodized sand alum.

(Price to be agreed. Production delay 4/5 weeks)

PLVOL 4413A /PLVOL 44139AS  
PLVOL 4413F /PLVOL 44139FS

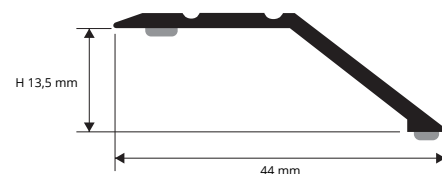

PLV... 4413A /PLV... 4413F

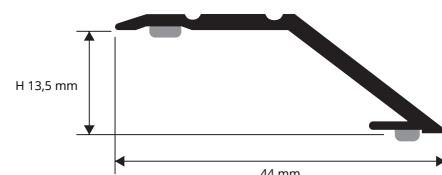

### EXAMPLES AND INSTRUCTIONS FOR LAYING METHODS

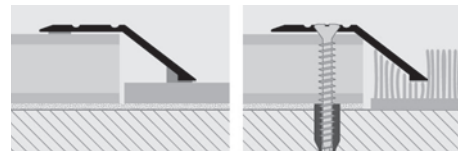

#### Adhesive version

1. Choose the suitable profile and cut it to the necessary length.
2. Degrease, wash and clean the solid surface thoroughly.
3. Remove the protective paper from the adhesive.
4. Lay the profile by applying pressure evenly over the whole surface without using a hammer.

#### Punched version

1. Choose the suitable profile and cut it to the necessary length.
2. Mark the position of the holes using the existing holes in the profile as reference.
3. Insert the screw anchors into the drilled holes.
4. Fix the profile using flathead screws suitable for the relative slots in the profile.

\* = Production on demand with minimum quantity of 100 pcs. Production delay 4/5 weeks. Price to be agreed



# PRONIVO

ANODIZED ALUMINIUM

**PRONIVO** is a transition and edging profile with a rounded shape in anodized aluminium with tap-down edge. It is ideal to give a clean-cut, elegant finish when joining and compensating differences in level of floors that are already laid and in differing or same materials e.g. ceramic tiles-wood-parquet. With its rounded shape it compensates for differences in thickness between 7 and 13 mm where no profile was installed at the time of laying. **PRONIVO** ensures a perfect finish and is easy to lay with the self-adhesive backing guaranteeing perfect adherence to the floor.

transition profiles

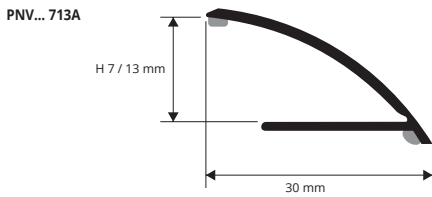

## EXAMPLES AND INSTRUCTIONS FOR LAYING METHODS

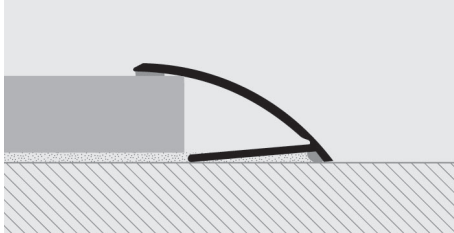

1. Choose the suitable profile and cut it to the necessary length.
2. Degrease, wash and clean the solid surface thoroughly.
3. Remove the protective paper from the adhesive.
4. Lay the profile by applying pressure evenly over the whole surface without using a hammer.



**ANODIZED ALUMINIUM self-adhesive thermo packed**  
bar length **2,7 lm** - pack **30 Pcs - 81 lm**

Article	H mm		
<b>PNVAA 713A</b>	<b>7/13</b>		

Available in the colours: AA (AO available on demand with a minimum quantity order of 100 pcs). The code of the selected colour must be added to the article code.  
E.g.: PNV... 713 (chosen colour anodized gold alum.) PNAO 713A.

## COLOURS



AA - Anodized silver alum.

**AVAILABLE MINIMUM QUANTITY 100 PCS** by color and height



AO - Anodized gold alum.

(Price to be agreed. Production delay 4/5 weeks)

# PROTRANS

ANODIZED ALUMINIUM

**PROTRANS** is a transition and edging profile with a rounded shape in anodized aluminium. It is ideal to give a clean-cut, elegant finish when joining and compensating differences in level of floors that are already laid and in differing or same materials e.g. ceramic tiles-wood-parquet. With its rounded shape it compensates for differences in thickness between 6 and 13 mm where no profile was installed at the time of laying. **PROTRANS** ensures a perfect finish and is easy to lay with the self-adhesive backing guaranteeing perfect adherence to the floor.

transition profiles

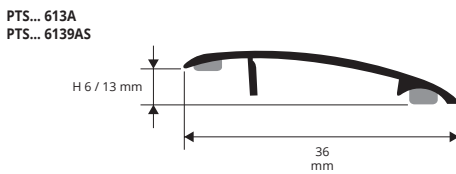

## EXAMPLES AND INSTRUCTIONS FOR LAYING METHODS

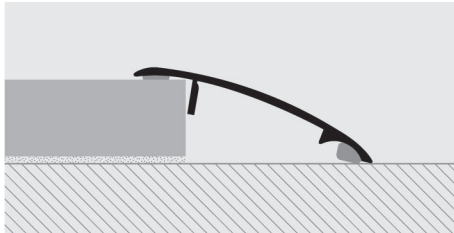

1. Choose the suitable profile and cut it to the necessary length.
2. Degrease, wash and clean the solid surface thoroughly.
3. Remove the protective paper from the adhesive.
4. Lay the profile by applying pressure evenly over the whole surface without using a hammer.



**ANODIZED ALUMINIUM self-adhesive thermo packed**  
bar length **2,7 lm** - pack **40 Pcs - 108 lm**

Article	H mm		
<b>PTSAA 613A</b>	<b>6 / 13</b>		

Available in the colours: AA (AO, AT, CH e SB available on demand with a minimum quantity order of 100 pcs). The code of the selected colour must be added to the article code. E.g.: PTS... 613A (chosen colour anodized gold alum.) PTSAA 613A.

**ANODIZED ALUMINIUM self-adhesive thermo packed** - bar length **0,90 lm** - pack **20 Pcs**



Article	H mm		
<b>PTS... 6139AS</b>	<b>6 / 13</b>		

## COLOURS



AA - Anodized silver alum.

**AVAILABLE MINIMUM QUANTITY 100 PCS** by color and height

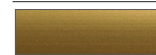

AO - Anodized gold alum.

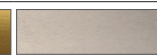

AT - Anodized titanium alum.

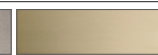

CH - Anod. champagne alum.

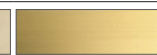

SB - Anod. sand aluminium

(Price to be agreed. Production delay 4/5 weeks)

**PROFLOOR 712** is a self-adhesive sloping terminal transition profile in AISI 304/1.4301-V2A stainless steel with protective film. It is used to give a clean-cut, elegant finish when joining and compensating differences in level of floors that are already laid and in differing or same materials e.g. ceramic tiles-wood-parquet-marble. It joins and compensates a thickness between 7 and 12mm. **PROFLOOR 712** ensures a perfect finish with little height, covering any flaws created during laying of the floor. Easy to lay; the high-strength elastomer adhesive ensures an excellent grip.



**POLISHED STAINLESS ST. AISI 304/1.4301-V2A self-adhesive thermo packed** - bar length **0,93 lm** - pack. **20 Pcs** 

Article	L x H mm
PFRAC 7129AS	38 X 7/12

**POLISHED STAINLESS ST. AISI 304/1.4301-V2A self-adhesive thermo packed** - bar length **1,66 lm** - pack. **20 Pcs** 

Article	L x H mm
PFRAC 71216AS	38 X 7/12

**POLISHED STAINLESS ST. AISI 304/1.4301-V2A self-adhesive thermo packed** - bar length **2,7 lm** - pack. **20 Pcs** - **54 lm**

Article	L x H mm
PFRAC 712A	38 X 7/12

**POLISHED STAINLESS ST. AISI 304/1.4301-V2A self-adhesive thermo packed** - bar length **0,83 lm** - pack. **20 Pcs** 

Article	L x H mm
PFRAC 7128AS	38 X 7/12

**POLISHED STAINLESS ST. AISI 304/1.4301-V2A self-adhesive thermo packed** - bar length **1,03 lm** - pack. **20 Pcs** 

Article	L x H mm
PFRAC 71210AS	38 X 7/12

#### COLOURS

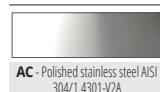

On demand hand-brushed stainless steel (Price to be agreed. Production delay 4/5 weeks)

SUITABLE FOR USE IN CONTACT WITH FOODSTUFFS.

**PROFLOOR 712** is a self-adhesive sloping terminal transition profile in polished brass with protective film. It is used to give a clean-cut, elegant finish when joining and compensating differences in level of floors that are already laid and in differing or same materials e.g. ceramic tiles-wood-parquet-marble. It joins and compensates a thickness between 7 and 12mm. **PROFLOOR 712** ensures a perfect finish with little height, covering any flaws created during laying of the floor. Easy to lay; the high-strength elastomer adhesive ensures an excellent grip.



**POLISHED BRASS self-adhesive thermo packed** bar length **0,93 lm** - pack. **20 Pcs** 

Article	L x H mm
PFROL 7129AS	38 X 7/12

**POLISHED BRASS self-adhesive thermo packed** bar length **1,66 lm** - pack. **20 Pcs** 

Article	L x H mm
PFROL 71216AS	38 X 7/12

**POLISHED BRASS self-adhesive thermo packed** bar length **2,7 lm** - pack. **20 Pcs** - **54 lm**

Article	L x H mm
PFROL 712A	38 X 7/12

**POLISHED BRASS self-adhesive thermo packed** bar length **0,83 lm** - pack. **20 Pcs** 

Article	L x H mm
PFROL 7128AS	38 X 7/12

**POLISHED BRASS self-adhesive thermo packed** bar length **1,03 lm** - pack. **20 Pcs** 

Article	L x H mm
PFROL 71210AS	38 X 7/12

#### COLOURS



OL - Polished brass

**PROFLOOR 712** is a self-adhesive sloping terminal transition profile in anodized aluminium with silver-gold-bronze finish with protective film. It is used to give a clean-cut, elegant finish when joining and compensating differences in level of floors that are already laid and in differing or same materials e.g. ceramic tiles-wood-parquet-marble. It joins and compensates a thickness between 7 and 12mm. **PROFLOOR 712** ensures a perfect finish with little height, covering any flaws created during laying of the floor. Easy to lay; the high-strength elastomer adhesive ensures an excellent grip.



**Anodized ALUMINIUM self-adhesive thermo packed** bar length **2,7 lm** - pack. **40 Pcs** - **108 lm**

Article	L x H mm
PFR... 712A	38 X 7/12



**Anodized ALUMINIUM self-adhesive thermo packed** - bar length **0,93 lm** - pack. **20 Pcs** 

Article	L x H mm
PFR... 7129AS	38 X 7/12

Available in the colours: AA - Anod. silver alum. AO - Anod. champagne alum. CH and SB available on demand with a minimum quantity order of 100 pcs. The code of the selected colour must be added to the article code. E.g.: PFR... 712A(chosen colour anodized gold alum.) PFR... 712A

## PROFLOOR 712

POLISHED STAINLESS STEEL  
AISI 304/1.4301-V2A WITH SELF-ADHESIVE

PFRAC 712A/7128AS/7129AS/71210AS/71216AS

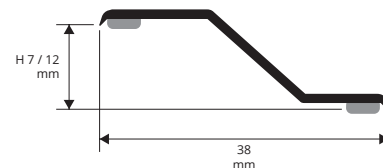

#### EXAMPLES AND INSTRUCTIONS FOR LAYING METHODS

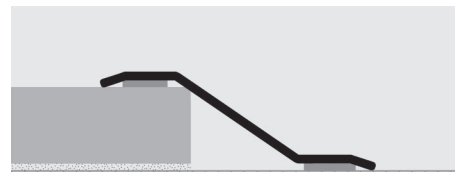

1. Choose the suitable profile and cut it to the necessary length.
2. Degrease, wash and clean the solid surface thoroughly.
3. Remove the protective paper from the adhesive.
4. Lay the profile by applying pressure evenly over the whole surface without using a hammer.

transition profiles

## PROFLOOR 712

POLISHED BRASS  
WITH SELF-ADHESIVE

PFROL 712A/7128AS/7129AS/71210AS/71216AS

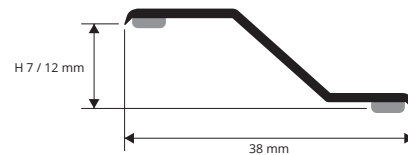

#### EXAMPLES AND INSTRUCTIONS FOR LAYING METHODS

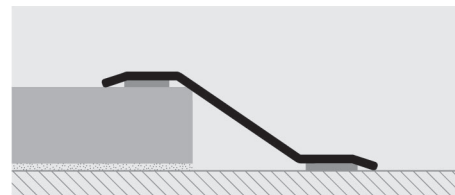

1. Choose the suitable profile and cut it to the necessary length.
2. Degrease, wash and clean the solid surface thoroughly.
3. Remove the protective paper from the adhesive.
4. Lay the profile by applying pressure evenly over the whole surface without using a hammer.

transition profiles

## PROFLOOR 712

ANODIZED GOLD, SILVER AND BRONZE  
ALUMINIUM WITH SELF-ADHESIVE

PFR... 712A/7129AS

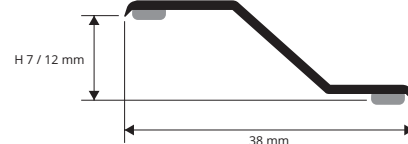

#### COLOURS



AA - Anodized silver alum. AO - Anodized gold alum. AB - Anodized Bronze Alum.

AVAILABLE MINIMUM QUANTITY 100 PCS by color and height



AT - Anodized titanium alum. CH - Anod. champagne alum. SB - Anod. sand aluminium

(Price to be agreed. Production delay 4/5 weeks)

transition profiles



# PROGRESS 712

POLISHED STAINLESS STEEL AISI 304/1.4301 AND POLISHED BRASS WITH SELF-ADHESIVE

**PROGRESS 712** is a self-adhesive sloping terminal transition profile in stainless steel 1.4301 and polished brass with protective film. It is used to give a clean-cut, elegant finish when joining and compensating differences in level of floors that are already laid and in differing or same materials e.g. ceramic tiles-wood-parquet-marble, etc. It joins and compensates a thickness between 7 and 12mm.

**PROGRESS 712** ensures a perfect finish with little height, covering any flaws created during laying of the floor. Easy to lay; the high-strength elastomer adhesive ensures an excellent grip.

transition profiles

PR SAC 712A/7129AS  
PR SOL 712A/7129AS

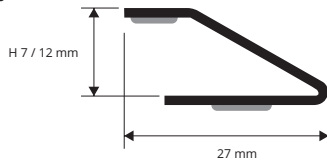

EXAMPLES AND INSTRUCTIONS FOR LAYING METHODS

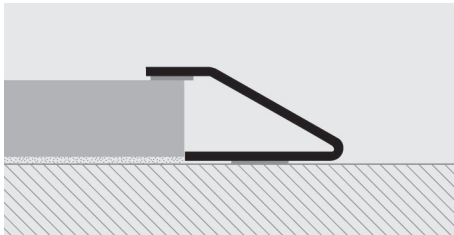

1. Choose the suitable profile and cut it to the necessary length.
2. Degrease, wash and clean the solid surface thoroughly.
3. Remove the protective paper from the adhesive.
4. Lay the profile by applying pressure evenly over the whole surface without using a hammer.



**POLISHED STAINLESS ST. AISI 304/1.4301-V2A self-adhesive thermo packed** - bar length 2,7 lm - pack. 20 Pcs - 54 lm

Article	H x L mm		
PR SAC 712A	27 X 7/12		

**POLISHED STAINLESS ST. AISI 304/1.4301-V2A self-adhesive thermo packed** - bar length 0,90 lm - pack. 20 Pcs  **SELF PACK**

Article	L x H mm		
PR SAC 7129AS	27 X 7/12		



**POLISHED BRASS self-adhesive thermo packed** bar length 2,7 lm - pack. 20 Pcs - 54 lm

Article	H x L mm		
PR SOL 712A	27 X 7/12		

**POLISHED BRASS self-adhesive thermo packed** bar length 0,90 lm - pack. 20 Pcs  **SELF PACK**

Article	L x H mm		
PR SOL 7129AS	27 X 7/12		

COLOURS



AC - Polished stainless steel AISI 304/1.4301-V2A

OL - Polished brass

SUITABLE FOR USE IN CONTACT WITH FOODSTUFFS.

On demand hand-brushed stainless steel  
(Price to be agreed. Production delay 4/5 weeks)

# PROFLOOR 1216

POLISHED STAINLESS STEEL AISI 304/1.4301 AND POLISHED BRASS WITH SELF-ADHESIVE

**PROFLOOR 1216** is a self-adhesive chamfered terminal transition profile in stainless steel AISI 304/1.4301-V2A and polished brass with protective film. It is used to give a clean-cut, elegant finish when joining and compensating differences in level of floors that are already laid and in differing or same materials e.g. ceramic tiles-wood-parquet-marble, etc. It joins and compensates a thickness between 12 and 16mm. **PROFLOOR 1216** ensures a perfect finish with little height, covering any flaws created during laying of the floor. Easy to lay; the high-strength elastomer adhesive ensures an excellent grip.

transition profiles

PFR AC 1216A/12169AS  
PFR OL 1216A/12169AS

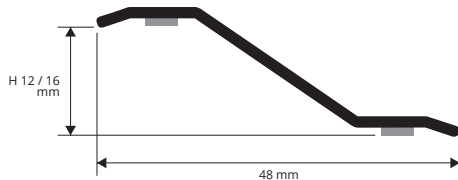

EXAMPLES AND INSTRUCTIONS FOR LAYING METHODS

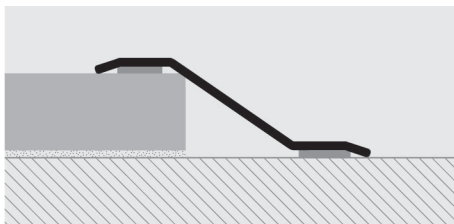

1. Choose the suitable profile and cut it to the necessary length.
2. Degrease, wash and clean the solid surface thoroughly.
3. Remove the protective paper from the adhesive.
4. Lay the profile by applying pressure evenly over the whole surface without using a hammer.



**POLISHED STAINLESS ST. AISI 304/1.4301-V2A self-adhesive thermo packed** - bar length 2,7 lm - pack. 20 Pcs - 54 lm

Article	L x H mm		
PFR AC 1216A	48 X 12/16		

**POLISHED STAINLESS ST. AISI 304/1.4301-V2A self-adhesive thermo packed** - bar length 0,93 lm - pack. 20 Pcs  **SELF PACK**

Article	L x H mm		
PFR AC 12169AS	48 X 12/16		

SUITABLE FOR USE IN CONTACT WITH FOODSTUFFS.

On demand hand-brushed stainless steel  
(Price to be agreed. Production delay 4/5 weeks)



**POLISHED BRASS self-adhesive thermo packed** bar length 2,7 lm - pack. 20 Pcs - 54 lm

Article	L x H mm		
PFR OL 1216A	48 X 12/16		

**POLISHED BRASS self-adhesive thermo packed** bar length 0,93 lm - pack. 20 Pcs  **SELF PACK**

Article	L x H mm		
PFR OL 12169AS	48 X 12/16		

COLOURS



AC - Polished stainless steel AISI 304/1.4301-V2A

OL - Polished brass



**PROLINOLEUM** is a self-adhesive transition profile in anodized aluminium with gold/silver finish. It is used to give a clean-cut, elegant finish to hardwearing surfaces in PVC or linoleum and other thin materials between 2-3 mm thick. **PROLINOLEUM** ensures a perfect finish with little height, covering any flaws created during laying of the floor. Easy to lay; the high-strength elastomer adhesive ensures an excellent grip.

# PROLINOLEUM

ANODIZED GOLD AND SILVER ALUMINIUM WITH AND WITHOUT SELF-ADHESIVE



**ANODIZED GOLD AND SILVER ALUMINIUM thermo packed**  
bar length 2,7 lm - pack. 40 Pcs - 108 lm

**ANODIZED GOLD AND SILVER ALUMINIUM thermo packed - WITH ADHESIVE** - bar length 2,7 lm - pack. 40 Pcs - 108 lm

Article	H x L mm
PLU ... 16	2,5 X 16

Article	H x L mm
PLU ... 16A	2,5 X 16

Available in the colours: AA (AO, AT, CH and SB available on demand with a minimum quantity order of 100 pcs). The code of the selected colour must be added to the article code.  
E.g.: PLU ... 16 (chosen finish anod. gold) PLUAO 16.

## COLOURS



AA - Anodized silver alum.

## AVAILABLE MINIMUM QUANTITY 100 PCS by color and height



AO - Anodized gold alum. AT - Anodized titanium alum. CH - Anod. champagne alum. SB - Anod. sand aluminium  
(Price to be agreed. Production delay 4/5 weeks)

PLU ... 16  
PLU ... 16A



## EXAMPLES AND INSTRUCTIONS FOR LAYING METHODS

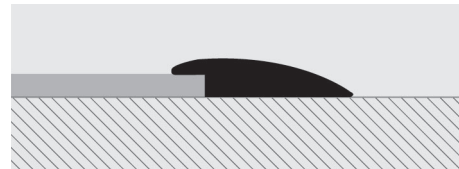

1. Choose the suitable profile and cut it to the necessary length.
2. Degrease, wash and clean the solid surface thoroughly.
3. Remove the protective paper from the adhesive.
4. Lay the profile by applying pressure evenly over the whole surface without using a hammer.

profiles for low thicknesses

**PROFLOOR 24** is a self-adhesive transition profile with chamfered edges in stainless steel 1.4016 and polished brass with protective film. It is used to give a clean-cut, elegant finish to hardwearing surfaces in PVC and linoleum - carpeting and other thin materials between 2 and 5mm thick. **PROFLOOR 24** ensures a perfect finish with little height, covering any flaws created during laying of the floor. Easy to lay; the high-strength elastomer adhesive ensures an excellent grip.

# PROFLOOR 24

POLISHED STAINLESS STEEL AISI 304/1.4301 AND POLISHED BRASS WITH SELF-ADHESIVE



**POLISHED STAINLESS ST. AISI 304/1.4301-V2A self-adhesive thermo packed** - bar length 2,7 lm - pack. 40 Pcs - 108 lm

**POLISHED BRASS self-adhesive thermo packed** bar length 2,7 lm - pack. 40 Pcs - 108 lm

Article	L x H mm
PFRAC 24A	2/4,5 X 30

Article	L x H mm
PFROL 24A	2/4,5 X 30

**POLISHED STAINLESS ST. AISI 304/1.4301-V2A self-adhesive thermo packed** - bar length 0,93 lm - pack. 20 Pcs  SELF PACK

**POLISHED BRASS self-adhesive thermo packed** bar length 0,93 lm - pack. 20 Pcs  SELF PACK

Article	L x H mm
PFRAC 249AS	2/4,5 X 30

Article	L x H mm
PFROL 249AS	2/4,5 X 30

SUITABLE FOR USE IN CONTACT WITH FOODSTUFFS.

On demand hand-brushed stainless steel  
(Price to be agreed. Production delay 4/5 weeks)

## COLOURS



AC - Polished stainless steel AISI 304/1.4301-V2A

OL - Polished brass

PFRAC 24A/249A  
PFROL 24A/249A

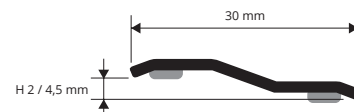

## EXAMPLES AND INSTRUCTIONS FOR LAYING METHODS

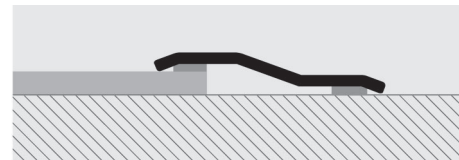

1. Choose the suitable profile and cut it to the necessary length.
2. Degrease, wash and clean the solid surface thoroughly.
3. Remove the protective paper from the adhesive.
4. Lay the profile by applying pressure evenly over the whole surface without using a hammer.

profiles for low thicknesses



# PROSLIDER KL ALL

ANODIZED SILVER ALUMINIUM

**PROSLIDER KL ALL** is a slide shape progressive transition terminal square suitable for connecting perfectly without steps two floor levels. The particular strength of the square allows to resist and bear heavy loads and frequent passages of manual trolleys and motor vehicles besides protecting the edge of the higher floor. The **PROSLIDER KL ALL** is especially used to connect LA Kerlite/Laminam and thin ceramic tiles to each other or else it is used with wood and/or a pre-existing floor. Available in anodized aluminium.

profiles for low thicknesses

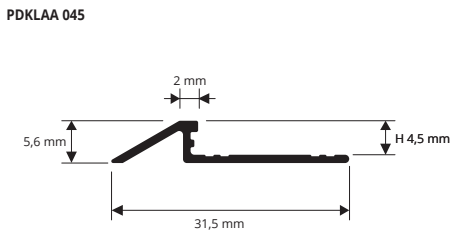

### EXAMPLES AND INSTRUCTIONS FOR LAYING METHODS

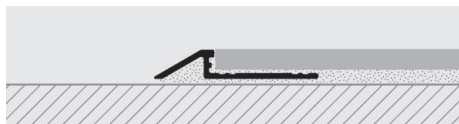

1. Choose the profile with the required finish.
2. Fill the profile cavity with adhesive and apply the adhesive onto the area of application.
3. Lay the "PROSLIDER KL ALL".
4. Align it flush with the floor/covering.
5. Use the adhesive to seal any empty interstices.

**ANODIZED SILVER ALUMINIUM thermo packed**  
bar length 2,7 lm - pack. 40 Pcs - 108 lm

Article	H mm		
PDKLAA 045	4,5		

### COLOURS

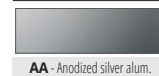

AA - Anodized silver alum.

# PROCOVER 1045 ALL

ANODIZED AND POLISHED SILVER, CHROME AND GOLD ALUMINIUM

**PROCOVER 1045 ALL** is a joint cover profile in anodized aluminium. It is applied at the end of the laying process between two adjoining floors placed at the same level, with a gap of 3 to 6 mm between the two kerlite /laminam/ or thin ceramic tile floors laid with the adhesive. It protects the external edge of the floor/covering. It is easy to lay and aesthetically pleasing. The design of the profile with lower vertical arrowhead part allows excellent anchorage with silicone / adhesive.

profiles for low thicknesses

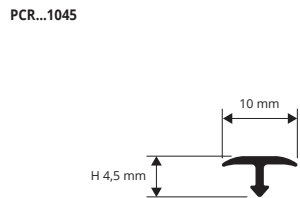

### EXAMPLES AND INSTRUCTIONS FOR LAYING METHODS



1. Choose "PROCOVER 1045 ALL" in the desired finish considering a side lap of 2/3 mm.
  2. Fill the gap with single-pack silicone or with the adhesive used for laying the floor.
  3. Bury the profile into the adhesive, making sure that both side laps of the profile rest on the coverings to be joined.
- IMPORTANT:** Take care of the external edges of the aluminium "PROCOVER 1045 ALL". They must be protected from aggressive substances such as adhesives and sealants and from smoothing or scraping action.

**ANODIZED SILVER ALUMINIUM thermo packed**  
bar length 2,7 lm - pack. 40 Pcs - 108 lm

Article	H mm		
PCRAA 1045	4,5		

**POLISHED CHROME/GOLD ALUMINIUM thermo packed**  
bar length 2,7 lm - pack. 40 Pcs - 108 lm

Article	H mm		
PCRBC 1045	4,5		
PCRBO 1045	4,5		

### COLOURS

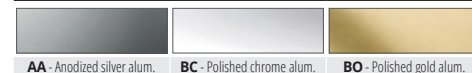

AA - Anodized silver alum. BC - Polished chrome alum. BO - Polished gold alum.







# PROCOVER

POLISHED AND BRUSHED  
STAINLESS STEEL AISI 304/1.4301-V2A

**PROCOVER** is a joint-cover profile in stainless steel (polished or brushed) with aluminium supports. It is applied at the end of laying two adjoining floors with the same height, having left a 6 - 24 mm gap between the two floors set in a thin bed of adhesive. It protects the outside edges of the floor/covering. It is easy to lay and attractive. The design of the profile with lower vertical arrowhead part allows excellent anchorage with the silicone/adhesive. The aluminium structure with the stainless steel lining provides it with a high level of resistance to cuts and deformation.

threshold - joint-cover profiles

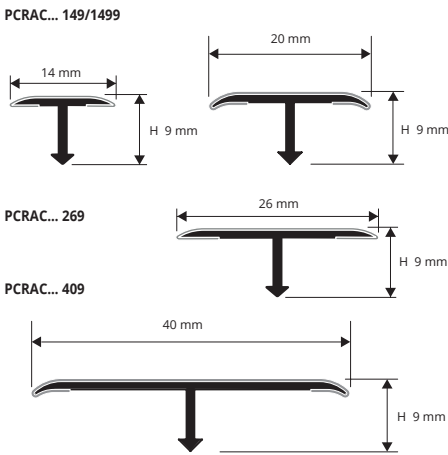

### EXAMPLES AND INSTRUCTIONS FOR LAYING METHODS

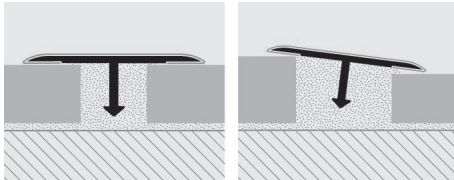

1. Choose the "PROCOVER" with the width suitable for the gap between the two floors to be joined, taking into consideration 2/3 mm side lap. 2. Fill the gap with single-pack silicone or with the adhesive used for laying the floor. 3. Bury the profile into the adhesive, making sure that both side laps of the profile rest on the coverings to be joined.

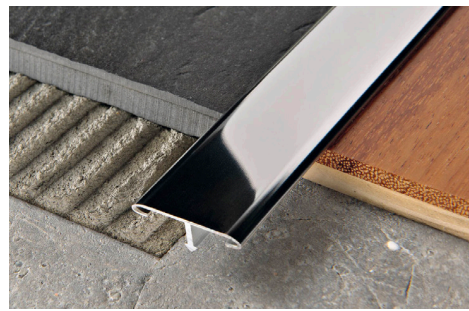

**POLISHED STAINLESS ST. AISI 304/1.4301-V2A**  
with protective film - bar length 2,7 lm  
(PCRAC 1499 - bar length 0,90 lm) - 4/10 mm



Article	Pcs/Pack	L x H mm
PCRAC 149	40	14 X 9
PCRAC 1499	20	14 X 9
PCRAC 209	40	20 X 9
PCRAC 269	30	26 X 9
PCRAC 409	20	40 X 9

### COLOURS

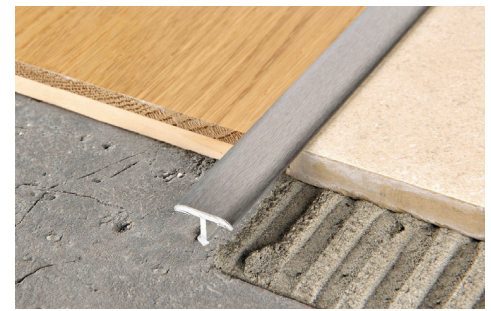

**BRUSHED STAINLESS ST. AISI 304/1.4301-V2A**  
with protective film - bar length 2,7 lm - 4/10 mm  
(PCRACS 1499 - bar length 0,90 lm - pack. 20 Pcs)



Article	Pcs/Pack	L x H mm
PCRACS 149	40	14 X 9
PCRACS 1499	20	14 X 9
PCRACS 209	40	20 X 9
PCRACS 269	30	26 X 9
PCRACS 409	20	40 X 9

SUITABLE FOR USE IN CONTACT WITH FOODSTUFFS.

# PROCOVER

POLISHED, CHROMED AND ANTIQUE BRASS

**PROCOVER** is a joint-cover profile in polished, chromed and antique brass. It is applied at the end of laying two adjoining floors with the same height, having left a 6 - 24 mm gap between the two floors set in a thin bed of adhesive. It protects the outside edges of the floor/covering. It is easy to lay and attractive. The design of the profile with lower vertical arrowhead part allows excellent anchorage with the silicone/adhesive.

threshold - joint-cover profiles

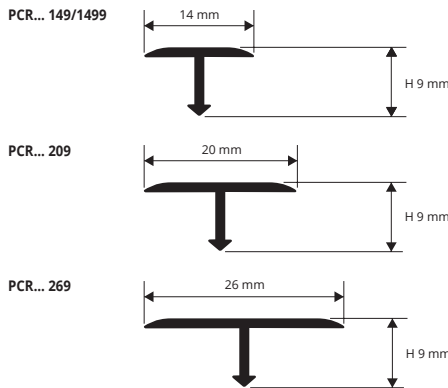

### EXAMPLES AND INSTRUCTIONS FOR LAYING METHODS

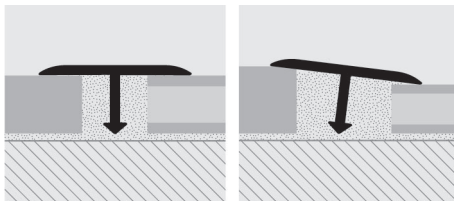

1. Choose the "PROCOVER" with the width suitable for the gap between the two floors to be joined, taking into consideration 2/3 mm side lap. 2. Fill the gap with single-pack silicone or with the adhesive used for laying the floor. 3. Bury the profile into the adhesive, making sure that both side laps of the profile rest on the coverings to be joined.

Profiles in natural or polished brass may be subject to oxidation in environments with high degrees of humidity. Resulting marks may be easily removed by polishing the profiles with specific products to be found on sale such as Sidol, Smac and similar.



**POLISHED BRASS thermo packed** - bar length 2,7 lm  
(PCROL 1499 - bar length 0,90 lm - pack. 40 Pcs)



Article	Pcs/Pack	L x H mm
PCROL 149	20	14 X 9
PCROL 1499	40	14 X 9
PCROL 209	20	20 X 9
PCROL 269	20	26 X 9

**CHROMED BRASS (polished stainless st. effect) thermo packed**  
bar length 2,7 lm - pack. 20 Pcs - 54 lm

Article	L x H mm
PCROC 149	14 X 9
PCROC 209	20 X 9
PCROC 269	26 X 9



**ANTIQUÉ BRASS thermo packed**  
bar length 2,7 lm - pack. 20 Pcs - 54 lm

Article	L x H mm
PCROB 149	14 X 9
PCROB 209	20 X 9
PCROB 269	26 X 9

**BRUSHED BRASS thermo packed**  
bar length 2,7 lm - pack. 20 Pcs - 54 lm

Article	L x H mm
PCROS 149	14 X 9
PCROS 209	20 X 9
PCROS 269	26 X 9

### COLOURS

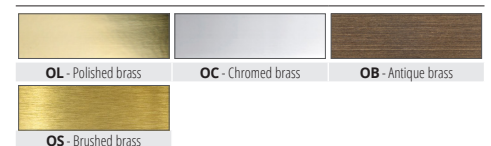

= News 2022

= Production on demand with minimum quantity of 100 pcs. Production delay 4/5 weeks. Price to be agreed

**PROCOVER** is a joint-cover profile in anodized aluminium. It is applied at the end of laying two adjoining floors with the same height, having left a 6 - 24 mm gap between the two floors set in a thin bed of adhesive. It protects the outside edges of the floor/covering. It is easy to lay and attractive. The design of the profile with lower vertical arrowhead part allows excellent anchorage with the silicone/adhesive.

# PROCOVER

ANODIZED SILVER, DARK BRONZE ALUMINIUM



**ANODIZED SILVER, DARK BRONZE ALUMINIUM thermo packed** - bar length 2,7 lm  
(PCRAA 1499 - bar length 0,90 lm - pack. 40 Pcs)



Article	Pcs/Pack	L x H mm
PCRAA 149	40	14 X 9
PCRDB 149	40	14 X 9
PCRAA 1499	40	14 X 9
PCRAA 209	40	20 X 9
PCRDB 209	40	20 X 9
PCRAA 269	40	26 X 9
PCRDB 269	40	26 X 9
PCRAA 409	20	40 X 9
PCRDB 409	20	40 X 9

### COLOURS

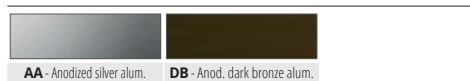

AVAILABLE MINIMUM QUANTITY 100 PCS by color and height

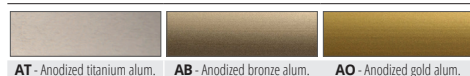

Available on demand PCRAT, PCRAB and PCRAO.

PCRAA - DB 149 curvable available

PCR... 149/1499

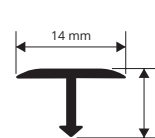

PCR... 209

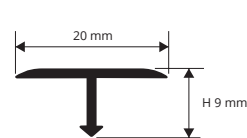

PCR... 269  
PCRAA 409

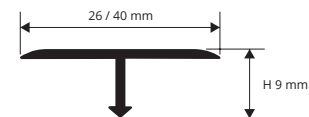

### EXAMPLES AND INSTRUCTIONS FOR LAYING METHODS

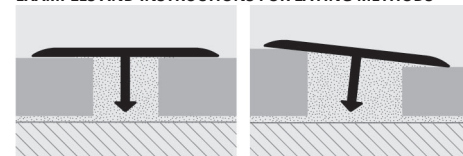

1. Choose the "PROCOVER" with the width suitable for the gap between the two floors to be joined, taking into consideration 2/3 mm side lap.
2. Fill the gap with single-pack silicone or with the adhesive used for laying the floor.
3. Bury the profile into the adhesive, making sure that both side laps of the profile rest on the coverings to be joined.

threshold - joint-cover profiles

**PROCOVER WOOD** is a joint-cover profile in aluminium covered with a very strong film available in 77 wooden finishes (72 on demand). It is applied at the end of laying two adjoining floors with the same height, having left a 6 - 24 mm gap between the two floors set in a thin bed of adhesive. It protects the outside edges of the floor/covering. It is easy to lay and attractive. The design of the profile with lower vertical arrowhead part allows excellent anchorage with the silicone/adhesive.

# PROCOVER WOOD

ALUMINIUM COVERED WITH PROTECTIVE FILM IN 77 WOODEN FINISHES (72 on demand)

**ALUMINIUM COVERED WOODEN FINISHES thermo packed**  
bar length 2,7 lm - pack. 40 Pcs - 108 lm (L 26 mm - 54 lm)

Article	L x H mm
PCRA... 149	14 X 9
PCRA... 269	26 X 9

Available in the wood finishes: 05W - 11W - 28W - 29W - 30W.  
The code of the selected colour must be added to the article code.  
Es.: PCRA... 149 (chosen finish light oak) PCRA04W 149.



### COLOURS



PCRA... 149

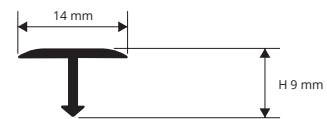

PCRA... 269

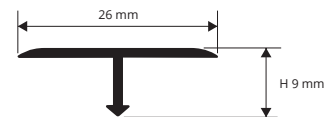

### EXAMPLES AND INSTRUCTIONS FOR LAYING METHODS

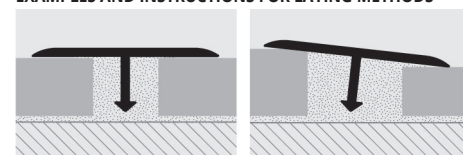

1. Choose the "PROCOVER" with the width suitable for the gap between the two floors to be joined, taking into consideration 2/3 mm side lap.
2. Fill the gap with single-pack silicone or with the adhesive used for laying the floor.
3. Bury the profile into the adhesive, making sure that both side laps of the profile rest on the coverings to be joined.

threshold - joint-cover profiles

# PROCOVER INSERT for inserting Procover profiles

VINYL RESIN / BLACK RUBBER

Vinyl resin/rubber profile "U-form" for inserting PROCOVER with PINBFT 45 or PINBFT 40 Proinsert System base.

**VINYL RESIN/RUBBER**  
length 2,7 lm and/or in rolls 100 lm

Article
PCPCR 2,7ML
PCPCR 100ML

**PROINSERT BASE 45 AND BASE 40 - alum. punched - perfored**  
bar length 2,7 lm - pack. 20 Pcs - 54 lm

Article	Larg. mm
PINBFT 45	45
PINBFT 40	40

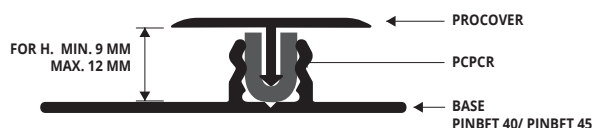

INSERT  
+BASE 45/40

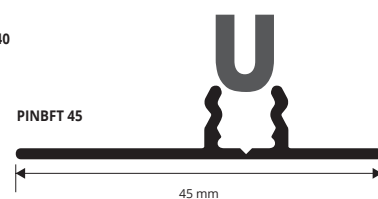

PINBFT 40



\* = Production on demand with minimum quantity of 100 pcs. Production delay 4/5 weeks. Price to be agreed



# PROPLATE

POLISHED STAINLESS 1.4016 STEEL  
SELF-ADHESIVE OR PUNCHED

PROPLATE is a flat joint-cover profile with special profiled edges for perfect adherence to flooring. Made in stainless steel 1.4016 with a protective film and available with or without adhesive or for certain widths also in the punched version. Available in widths of 20 - 30 - 40 - 60 - 80 mm with protective film.

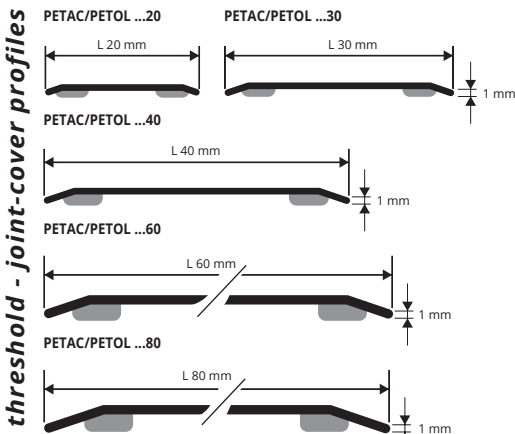

**POLISHED STAINLESS 1.4016 ST. thermo packed - ADHESIVE**  
bar length 2,70 lm - pack. 20 Pcs - 54 lm (L 20 - 30mm - 108 lm) - 10/10 mm

Article	Width
PETAC 20A	20mm
PETAC 30A	30mm
PETAC 40A	40mm
PETAC 60A	60mm
PETAC 80A	80mm

**POLISHED STAINLESS 1.4016 ST. thermo packed ADHESIVE** bar length 0,93 lm - pack. 20 Pcs - 10/10 mm SELF PACK

Article	Width
PETAC 309AS	30mm
PETAC 609AS	60mm
PETAC 809AS	80mm

**POLISHED STAINLESS 1.4016 STEEL thermo packed - without holes**  
bar length 2,70 lm - pack. 20 Pcs - 54 lm - 10/10 mm

Article	Width
PETAC 60	60mm
PETAC 80	80mm

**POLISHED STAINLESS 1.4016 ST. thermo packed - PUNCHED WITH SCREWS** SELF PACK  
bar length 0,93 lm - pack. 20 Pcs - 10/10 mm

Article	Width
PETAC 309FS	30mm

PETAC 60A/80A/60/80, with 12/10 thickness available on demand.

**PUNCHED POLISHED STAINLESS 1.4016 ST. with protective film**  
bar length 2,70 lm - pack. 20 Pcs - 54 lm (L 30mm - 108 lm) - 10/10 mm

Article	Width
PETAC 30F	30mm
PETAC 40F	40mm

## COLOURS



## EXAMPLES AND INSTRUCTIONS FOR LAYING METHODS

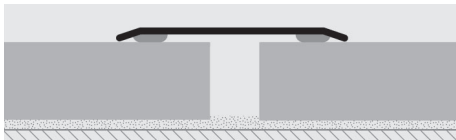

1. Choose "PROPLATE" in the required width and material and whether punched or with self-adhesive backing. 2. Cut the profile to the required length. When laying the self-adhesive Proplate, clean, degrease and dry the surface, checking that the temperature for application is at least 15°. 3. Remove the protective paper from the adhesive and lay the profile correctly applying a uniform vertical pressure by hand without moving the profile and without using iron/steel hammers. 4. When laying the punched version, align the profile and mark the position of the holes using the holes in the profile as reference. 5. Insert suitable screw anchors (usually Ø 3mm screws & 5x25mm screw anchors) 6. Align the profile and tighten the galvanised or brass flathead screws.

# PROPLATE

POLISHED BRASS  
SELF-ADHESIVE OR PUNCHED

PROPLATE is a flat joint-cover profile with special profiled edges for perfect adherence to flooring. Made in polished brass with a protective film and available with or without adhesive or for certain widths also in the punched version. Available in widths of 20 - 30 - 40 - 60 - 80 mm with protective film.

## EXAMPLES AND INSTRUCTIONS FOR LAYING METHODS

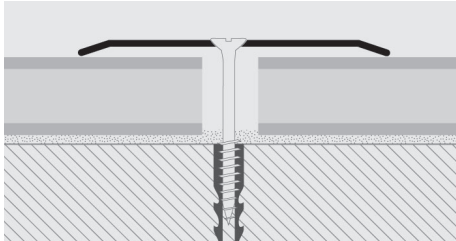

1. Choose "PROPLATE" in the required width and material and whether punched or with self-adhesive backing. 2. Cut the profile to the required length. When laying the self-adhesive Proplate, clean, degrease and dry the surface, checking that the temperature for application is at least 15°. 3. Remove the protective paper from the adhesive and lay the profile correctly applying a uniform vertical pressure by hand without moving the profile and without using iron/steel hammers. 4. When laying the punched version, align the profile and mark the position of the holes using the holes in the profile as reference. 5. Insert suitable screw anchors (usually Ø 3mm screws & 5x25mm screw anchors) 6. Align the profile and tighten the galvanised or brass flathead screws.

## COLOURS

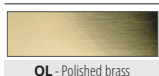

**POLISHED BRASS thermo packed ADHESIVE**  
bar length 2,70 lm - pack. 20 Pcs - 54 lm (L 20/30mm - 108 lm) - 10/10 mm

Article	Width
PETOL 20A	20mm
PETOL 30A	30mm
PETOL 40A	40mm
PETOL 60A	60mm
PETOL 80A	80mm

**POLISHED BRASS thermo packed ADHESIVE** bar length 0,83 lm - pack. 20 Pcs - 10/10 mm SELF PACK

Article	Width
PETOL 308AS	30mm
PETOL 408AS	40mm

**POLISHED BRASS thermo packed** bar length 0,93 lm - pack. 20 Pcs - 10/10 mm SELF PACK

Article	Width
PETOL 309AS	30mm
PETOL 309FS	30mm
PETOL 409AS	40mm
PETOL 409FS	40mm
PETOL 609AS	60mm
PETOL 809AS	80mm

"AS" at the end of the product code = Item with adhesive  
"FS" at the end of the product code = Punched Item

**POLISHED BRASS thermo packed WITHOUT HOLES**  
bar length 2,70 lm - pack. 20 Pcs - 54 lm (L 20 mm - 108 lm) - 10/10 mm

Article	Width
PETOL 20	20mm
PETOL 60	60mm
PETOL 80	80mm

**POLISHED BRASS thermo packed** bar length 1,03 lm - pack. 20 Pcs - 10/10 mm SELF PACK

Article	Width
PETOL 3010AS	30mm
PETOL 4010AS	40mm
PETOL 4010FS	40mm

"AS" at the end of the product code = Item with adhesive  
"FS" at the end of the product code = Punched Item

PETOL 60A/80A/60/80 with 13/10 thickness available on demand.

**POLISHED BRASS with protective film PUNCHED**  
bar length 2,70 lm - pack. 20 Pcs - 54 lm (L 30 mm - 108 lm) - 10/10 mm

Article	Width
PETOL 30F	30mm
PETOL 40F	40mm

**POLISHED BRASS thermo packed ADHESIVE** bar length 1,66 lm - pack. 20 Pcs - 10/10 mm SELF PACK

Article	Width
PETOL 3016AS	30mm
PETOL 4016AS	40mm

\* = Production on demand with minimum quantity of 100 pcs. Production delay 4/5 weeks. Price to be agreed

**PROPLATE 80 ALZ** is a new aluminium joint cover, threshold cover. It is very resistant and suitable for covering the expanding joint of two different supporting structures, or to connect a floor with an adjoining one of the same or different kind. Particularly used in Industrial field, in the malls, sport facilities and gyms equipped with wood and/or resin floors.

# PROPLATE 80 ALZ

KNURLED ANODIZED SILVER ALUMINIUM



**ANODIZED SILVER ALUMINIUM thermo packed ADHESIVE**  
bar length 2,7 lm - pack. 20 Pcs - 54 lm (PETAA 80Z - 40,5 lm)

Article	Width mm
PETAA 80ZA	80

**ANODIZED SILVER ALUMINIUM thermo packed**  
bar length 2,7 lm - pack. 20 Pcs - 54 lm (PETAA 80Z - 40,5 lm)

Article	Width mm
PETAA 80Z	80

## COLOURS



AA - Anodized silver alum.

Punched version available on demand.

PETAA 80ZA  
PETAA 80Z

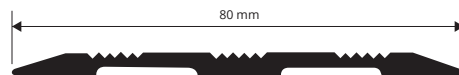

## EXAMPLES AND INSTRUCTIONS FOR LAYING METHODS

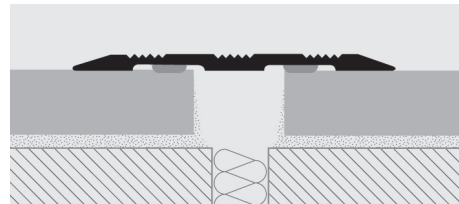

1. Choose "PROPLATE 80ALZ" model with or without sticker and cut it to the required length.

### Adhesive version

2. Degrease, wash and clean accurately the solid floor. 3. Remove the protective label from the sticker (sticker model). 4. Rest the square pressing evenly without hammering.

### Punched version

2. Perforate on one side and insert the nogs in the holes. 3. Fix and screw the square equipped with flared head screws suitable to the holes made.

threshold - joint-cover profiles

**PROCOVER 14PT** is a small aluminium joint cover / threshold cover square. It is used to finish technically floors laid at the same level in ceramic tiles/ ceramics ceramics / wood. It covers eventual laying flaws and guarantees that the floors which are underneath expand enough. In Gold-Silk anodized Aluminium and Bronze with sticker.

# PROCOVER 14PT

ANODIZED SILVER, GOLD AND BRONZE ALUMINIUM



**ANODIZED ALUMINIUM WITH ADHESIVE thermo packed**  
bar length 2,7 lm - pack. 40 Pcs - 108 lm

Article	Width mm
PCRAA 14PTA	14
PCRAO 14PTA	14
PCRAB 14PTA	14

## COLOURS

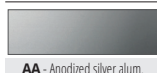

AA - Anodized silver alum.

AVAILABLE MINIMUM QUANTITY 100 PCS by color and height



AO - Anodized gold alum. AB - Anodized bronze alum.

(Price to be agreed. Production delay 4/5 weeks)

PCRAA 14PTA  
PCRAO 14PTA  
PCRAB 14PTA

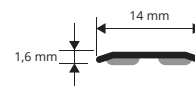

## EXAMPLES AND INSTRUCTIONS FOR LAYING METHODS

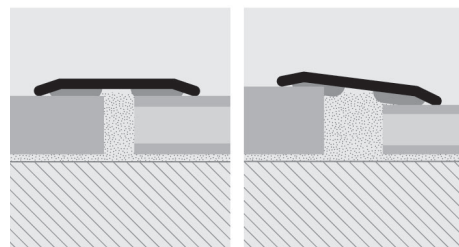

1. Choose the superficial finish of "PROCOVER 14PT" and cut it to the required length. 2. Degrease, wash and clean accurately the solid floor. 3. Remove the protective label from the sticker. 4. Lay the square pressing evenly without hammering.

threshold - joint-cover profiles







**PROSOL 18-30-35-40** in steel are self-adhesive joint - covers in stainless steel 1.4016 available in various widths. They are used to join floors of the same or differing material and thickness. The rounded shape also allows the profile to be used to edge shallow floors max. 5 mm thick. **PROSOL** is normally used to cover flaws and defects created during laying of ceramic/wood/parquet floors by covering the joint/threshold. **PROSOL** is recommended for all sorts of public environments: hotels, offices, shops and private dwellings; it guarantees an impeccable and attractive finish.

# PROSOL 18-30-35-40

STAINLESS STEEL 1.4016 WITH  
SELF-ADHESIVE WITH PROTECTIVE FILM



STAINLESS ST. 1.4016 with adhesive thermo packed  
bar length 2,7 lm - pack. 40 Pcs - 108 lm (L 35/40 mm - 54 lm)

Article	Width-thick.
PLSAC 18A	18 mm - 10/10
PLSAC 30A	30 mm - 10/10
PLSAC 35A	35 mm - 10/10
PLSAC 40A	40 mm - 12/10

STAINLESS ST. 1.4016 with adhesive  
thermo packed - bar length 0,83 lm - pack. 20 Pcs



Article	Width-thick.
PLSAC 308A	30 mm - 10/10
PLSAC 358A	35 mm - 10/10

On demand 0,73 or 0,63 lm bar length (quantity and prices to be agreed. Production delay 4/5 weeks).

STAINLESS ST. 1.4016 with adhesive  
thermo packed - bar length 0,90 lm - pack. 20 Pcs



Article	Width-thick.
PLSAC 189A	18 mm - 10/10

STAINLESS ST. 1.4016 with adhesive  
thermo packed - bar length 0,93 lm - pack. 20 Pcs



Article	Width-thick.
PLSAC 309A	30 mm - 10/10
PLSAC 359A	35 mm - 10/10



STAINLESS ST. 1.4016 with adhesive  
thermo packed - bar length 0,83 lm - pack. 20 Pcs



Article	Width-thick.
PLSAC 308AS	30 mm - 10/10
PLSAC 358AS	35 mm - 10/10

On demand 0,73 or 0,63 lm bar length (quantity and prices to be agreed. Production delay 4/5 weeks).

STAINLESS ST. 1.4016 with adhesive  
thermo packed - bar length 0,93 lm - pack. 20 Pcs



Article	Width-thick.
PLSAC 309AS	30 mm - 10/10
PLSAC 359AS	35 mm - 10/10
PLSAC 409AS	40 mm - 12/10

STAINLESS ST. 1.4016 with adhesive  
thermo packed - bar length 1,03 lm - pack. 20 Pcs



Article	Width-thick.
PLSAC 3010AS	30 mm - 10/10

STAINLESS ST. 1.4016 with adhesive  
thermo packed - bar length 1,66 lm - pack. 20 Pcs



Article	Width-thick.
PLSAC 3016AS	30 mm - 10/10
PLSAC 3516AS	35 mm - 10/10

PLSAC 18A/189A

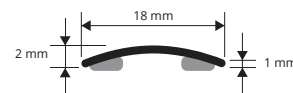

PLSAC 30A/3010AS/309A/309AS/308A/308AS/3016AS

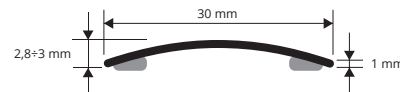

PLSAC 35A/359A/359AS/358A/358AS

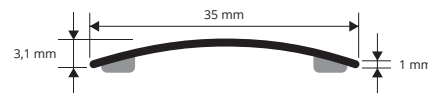

PLSAC 40A/409AS

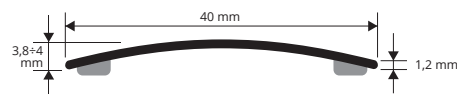

threshold - joint-cover profiles

### EXAMPLES AND INSTRUCTIONS FOR LAYING METHODS

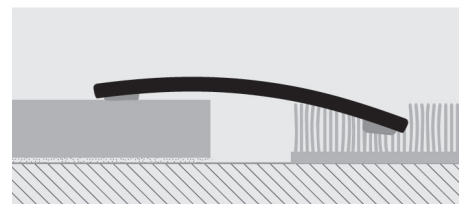
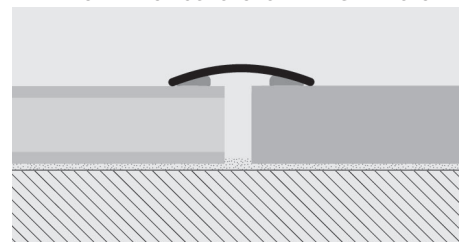

1. Choose the suitable profile and cut it to the necessary length.
2. Degrease, wash and clean the solid surface thoroughly.
3. Remove the protective paper from the adhesive.
4. Lay the profile by applying pressure evenly over the whole surface without using a hammer.

### COLOURS



On demand hand-brushed stainless steel  
(Prices to be agreed. Production delay 4/5 weeks)

AC - Polished stainless steel 1.4016

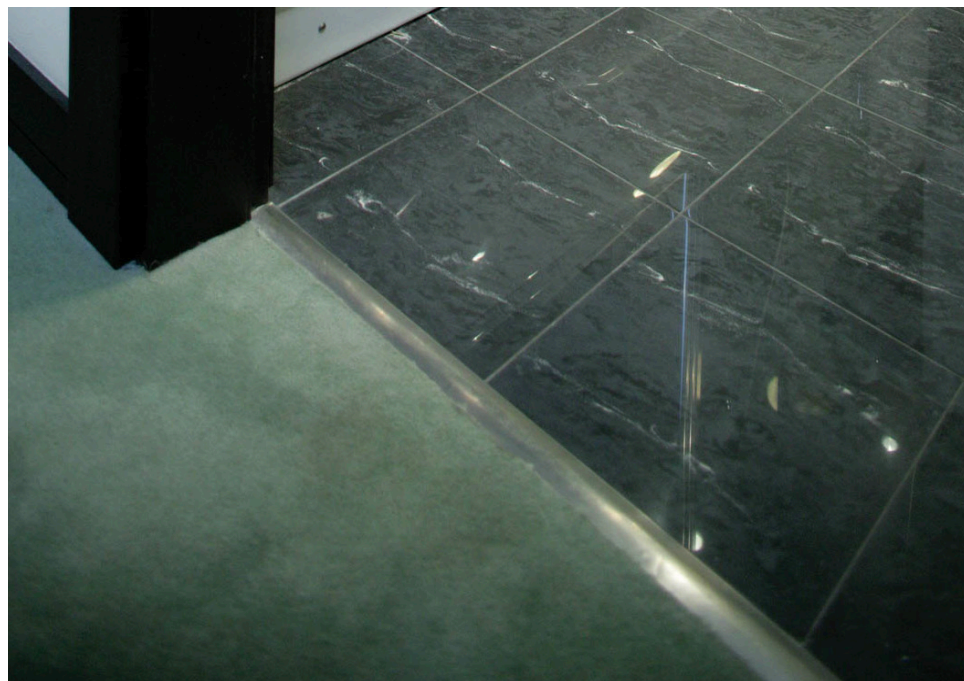

\* = Production on demand with minimum quantity of 100 pcs. Production delay 4/5 weeks. Price to be agreed



# PROSOL 30-35-40

PUNCHED STAINLESS STEEL 1.4016 WITH PROTECTIVE FILM

**PROSOL 30-35-40** in steel are punched joint - covers in stainless steel 1.4016 available in various widths. They are used to join floors of the same or differing material and thickness. The rounded shape also allows the profile to be used to edge shallow floors max. 5 mm thick. **PROSOL** is normally used to cover flaws and defects created during laying of ceramic/wood/parquet floors by covering the joint/threshold. **PROSOL** is recommended for all sorts of public environments: hotels, offices, shops and private dwellings; it guarantees an impeccable and attractive finish.

PLSAC 30F/308F/309F/308FS/309FS/3010FS/3016FS

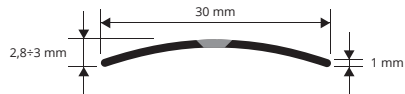

PLSAC 35F/358F/359F/358FS/359FS/3516FS

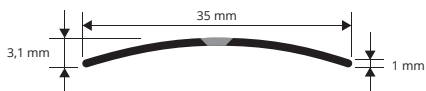

PLSAC 40F/409FS

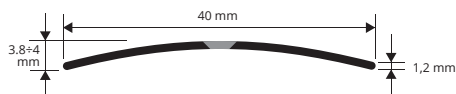

## EXAMPLES AND INSTRUCTIONS FOR LAYING METHODS

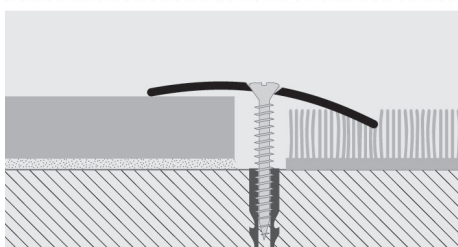
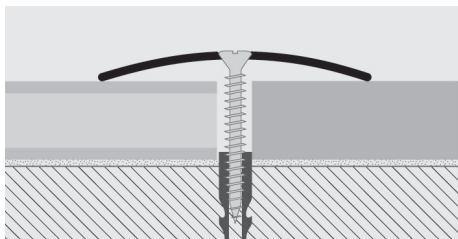

1. Choose the suitable profile and cut it to the necessary length.
2. Mark the position of the holes using the existing holes in the profile as reference.
3. Insert the screw anchors into the drilled holes.
4. Fix the profile using flathead screws suitable for the relative slots in the profile.

**STAINLESS ST. 1.4016 punched - with protective film**  
bar length 2,7 lm - pack. 20 Pcs - 54 lm (L 30 mm - 108 lm)

Article	Width-thick.		
PLSAC 30F	30 mm - 10/10		
PLSAC 35F	35 mm - 10/10		
PLSAC 40F	40 mm - 12/10		

**STAINLESS ST. 1.4016 punched thermo packed**  
bar length 0,83 lm - pack. 20 Pcs



Article	Width-thick.		
PLSAC 308F	30 mm - 10/10		
PLSAC 358F	35 mm - 10/10		*

**STAINLESS ST. 1.4016 punched thermo packed**  
bar length 0,93 lm - pack. 20 Pcs



Article	Width-thick.		
PLSAC 309F	30 mm - 10/10		
PLSAC 359F	35 mm - 10/10		*

**STAINLESS ST. 1.4016 punched with screws and screw anchors thermo packed** - bar length 0,83 lm - pack. 20 Pcs



Article	Width-thick.		
PLSAC 308FS	30 mm - 10/10		
PLSAC 358FS	35 mm - 10/10		*

**STAINLESS ST. 1.4016 punched with screws and screw anchors thermo packed** - bar length 0,93 lm - pack. 20 Pcs



Article	Width-thick.		
PLSAC 309FS	30 mm - 10/10		
PLSAC 359FS	35 mm - 10/10		*
PLSAC 409FS	40 mm - 12/10		*

**STAINLESS ST. 1.4016 punched with screws and screw anchors thermo packed** - bar length 1,03 lm - pack. 20 Pcs



Article	Width-thick.		
PLSAC 3010FS	30 mm - 10/10		

**STAINLESS ST. 1.4016 punched with screws and screw anchors thermo packed** - bar length 1,66 lm - pack. 20 Pcs



Article	Width-thick.		
PLSAC 3016FS	30 mm - 10/10		
PLSAC 3516FS	35 mm - 10/10		*

## COLOURS



On demand hand-brushed stainless steel (Prices to be agreed. Production delay 4/5 weeks)

\* = Production on demand with minimum quantity of 100 pcs. Production delay 4/5 weeks. Price to be agreed



**PROSOL 18-30-35-40** in brass are self-adhesive joint - covers in polished brass available in various widths. They are used to join floors of the same or differing material and thickness. The rounded shape also allows the profile to be used to edge shallow floors max. 5 mm thick. **PROSOL** is normally used to cover flaws and defects created during laying of ceramic/wood/parquet floors by covering the joint/threshold. **PROSOL** is recommended for all sorts of public environments: hotels, offices, shops and private dwellings; it guarantees an impeccable and attractive finish.

# PROSOL 18-30-35-40

POLISHED BRASS WITH SELF-ADHESIVE WITH PROTECTIVE FILM



**POLISHED BRASS with adhesive thermo packed**  
bar length 2,7 lm - pack. 40 Pcs - 108 lm (L 35/40mm - 54 lm)

Article	Width-thick.		
PLSOL 18A	18 mm - 10/10		
PLSOL 30A	30 mm - 10/10		
PLSOL 35A	35 mm - 10/10		
PLSOL 40A	40 mm - 10/10		

**POLISHED BRASS with adhesive thermo packed**  
bar length 0,83 lm - pack. 20 Pcs

Article	Width-thick.		
PLSOL 308AS	30 mm - 10/10		
PLSOL 358AS	35 mm - 10/10		

**POLISHED BRASS with adhesive thermo packed**  
bar length 0,83 lm - pack. 20 Pcs

Article	Width-thick.		
PLSOL 308A	30 mm - 10/10		

On demand 0,73 or 0,63 lm bar length (quantity and prices to be agreed. Production delay 4/5 weeks).

**POLISHED BRASS with adhesive thermo packed**  
bar length 0,90 lm - pack. 20 Pcs

Article	Width-thick.		
PLSOL 189A	10 mm - 10/10		

**POLISHED BRASS with adhesive thermo packed**  
bar length 0,93 lm - pack. 20 Pcs

Article	Width-thick.		
PLSOL 309A	30 mm - 10/10		
PLSOL 359A	35 mm - 10/10		
PLSOL 409A	40 mm - 10/10		

**POLISHED BRASS with adhesive thermo packed**  
bar length 1,03 lm - pack. 20 Pcs

Article	Width-thick.		
PLSOL 3010A	30 mm - 10/10		

**POLISHED BRASS with adhesive thermo packed**  
bar length 1,66 lm - pack. 20 Pcs

Article	Width-thick.		
PLSOL 3016A	30 mm - 10/10		

**POLISHED BRASS with adhesive thermo packed**  
bar length 0,93 lm - pack. 20 Pcs

Article	Width-thick.		
PLSOL 309AS	30 mm - 10/10		
PLSOL 359AS	35 mm - 10/10		
PLSOL 409AS	40 mm - 10/10		

**POLISHED BRASS with adhesive thermo packed**  
bar length 1,03 lm - pack. 20 Pcs

Article	Width-thick.		
PLSOL 3010AS	30 mm - 10/10		
PLSOL 3510AS	35 mm - 10/10		

**POLISHED BRASS with adhesive thermo packed**  
bar length 1,66 lm - pack. 20 Pcs

Article	Width-thick.		
PLSOL 3016AS	30 mm - 10/10		
PLSOL 3516AS	35 mm - 10/10		
PLSOL 4016AS	40 mm - 10/10		

## COLOURS



OL - Polished brass

PLSOL 18A/189A

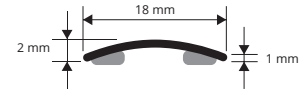

PLSOL 30A/308A/309A/3010A/3016A/308AS/309AS/3010AS/3016AS

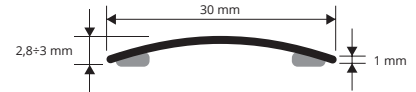

PLSOL 35A/359A/358AS/359AS/3510AS/3516AS

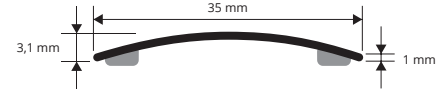

PLSOL 40S/409S/409SS/416SS

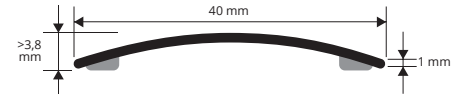

threshold - joint-cover profiles

## EXAMPLES AND INSTRUCTIONS FOR LAYING METHODS

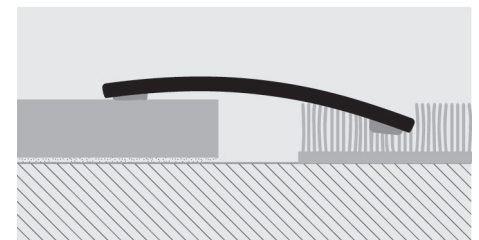
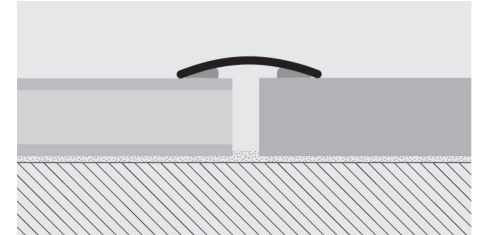

1. Choose the suitable profile and cut it to the necessary length.
2. Degrease, wash and clean the solid surface thoroughly.
3. Remove the protective paper from the adhesive.
4. Lay the profile by applying pressure evenly over the whole surface without using a hammer.

\* = Production on demand with minimum quantity of 100 pcs. Production delay 4/5 weeks. Price to be agreed



# PROSOL 30-35-40

PUNCHED POLISHED BRASS WITH PROTECTIVE FILM

**PROSOL 30-35-40** in brass are punched joint - covers in polished brass available in various widths. They are used to join floors of the same or differing material and thickness. The rounded shape also allows the profile to be used to edge shallow floors max. 5 mm thick. **PROSOL** is normally used to cover flaws and defects created during laying of ceramic/wood/parquet floors by covering the joint/threshold. **PROSOL** is recommended for all sorts of public environments: hotels, offices, shops and private dwellings; it guarantees an impeccable and attractive finish.

PLSOL 30F/308F/309F/3010F/3016F/308FS/309FS/3010FS/3016FS

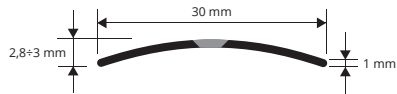

PLSOL 35F/359F/358F/359FS/3510FS/3516FS

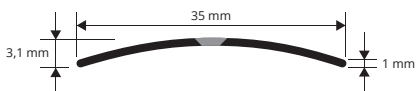

PLSOL 40F/409F/409FS/4016FS

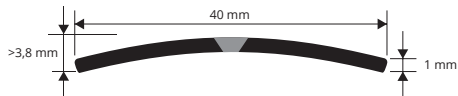

## EXAMPLES AND INSTRUCTIONS FOR LAYING METHODS

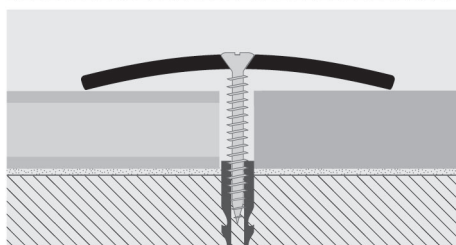
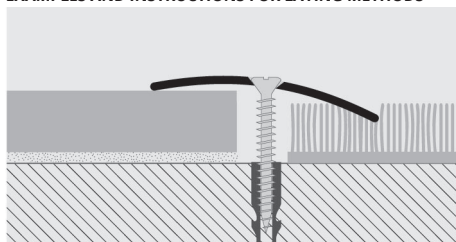

1. Choose the suitable profile and cut it to the necessary length.
2. Mark the position of the holes using the existing holes in the profile as reference.
3. Insert the screw anchors into the drilled holes.
4. Fix the profile using flathead screws suitable for the relative slots in the profile.

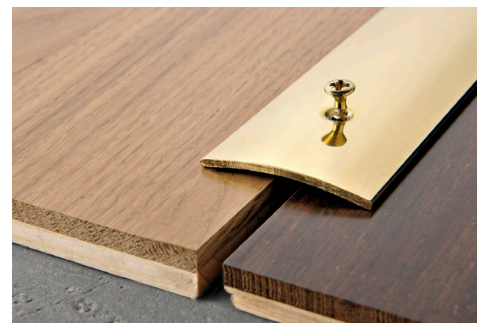

**POLISHED BRASS punched with protective film**  
bar length 2,7 lm - pack. 40 Pcs - 108 lm (L 35/40mm - 54 lm)

Article	Width-thick.
PLSOL 30F	30 mm - 10/10
PLSOL 35F	35 mm - 10/10
PLSOL 40F	40 mm - 10/10

**POLISHED BRASS punched thermo packed**  
bar length 0,83 lm - pack. 20 Pcs



Article	Width-thick.
PLSOL 308F	30 mm - 10/10

**POLISHED BRASS punched thermo packed**  
bar length 0,93 lm - pack. 20 Pcs



Article	Width-thick.
PLSOL 309F	30 mm - 10/10
PLSOL 359F	35 mm - 10/10
PLSOL 409F	40 mm - 10/10

**POLISHED BRASS punched thermo packed**  
bar length 1,03 lm - pack. 20 Pcs



Article	Width-thick.
PLSOL 3010F	30 mm - 10/10

**POLISHED BRASS punched thermo packed**  
bar length 1,66 lm - pack. 20 Pcs



Article	Width-thick.
PLSOL 3016F	30 mm - 10/10

**POLISHED BRASS punched with screws and screw anchors thermo packed** - bar length 0,83 lm - pack. 20 Pcs



Article	Width-thick.
PLSOL 308FS	30 mm - 10/10
PLSOL 358FS	35 mm - 10/10

On demand 0,73 or 0,63 lm bar length (quantity and prices to be agreed. Production delay 4/5 weeks).

**POLISHED BRASS punched with screws and screw anchors thermo packed** - bar length 0,93 lm - pack. 20 Pcs



Article	Width-thick.
PLSOL 309FS	30 mm - 10/10
PLSOL 359FS	35 mm - 10/10
PLSOL 409FS	40 mm - 10/10

**POLISHED BRASS punched with screws and screw anchors thermo packed** - bar length 1,03 lm - pack. 20 Pcs



Article	Width-thick.
PLSOL 3010FS	30 mm - 10/10
PLSOL 3510FS	35 mm - 10/10

**POLISHED BRASS punched with screws and screw anchors thermo packed** - bar length 1,66 lm - pack. 20 Pcs



Article	Width-thick.
PLSOL 3016FS	30 mm - 10/10
PLSOL 3516FS	35 mm - 10/10
PLSOL 4016FS	40 mm - 10/10

## COLOURS

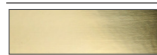

OL - Polished brass

\* = Production on demand with minimum quantity of 100 pcs. Production delay 4/5 weeks. Price to be agreed



**PROSOL 30-35-40** are self-adhesive or punched joint - covers in polished brass available in various widths. They are used to join floors of the same or differing material and thickness. The rounded shape also allows the profile to be used to edge shallow floors max. 5 mm thick. **PROSOL** is normally used to cover flaws and defects created during laying of ceramic/wood/parquet floors by covering the joint/threshold. **PROSOL** is recommended for all sorts of public environments: hotels, offices, shops and private dwellings; it guarantees an impeccable and attractive finish.

# PROSOL 30-35-40

ANODIZED GOLD AND SILVER  
ALUMINIUM WITH SELF-ADHESIVE AND PUNCHED

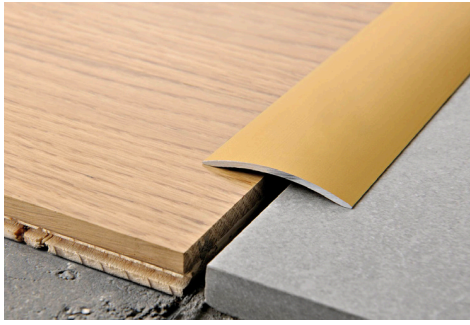

**ANODIZED ALUMINIUM with adhesive thermo packed**  
bar length 2,7 lm - pack. 40 Pcs - 108 lm

Article	Width-thick.		
PLS... 30A	30 mm - 1,3		
PLSAA 35A	35 mm - 1,5		
PLSAA 40A	40 mm - 2		

Available in the colours: AA - AO (AB, AT, CH and SB available on demand with a minimum quantity order of 100 pcs). The code of the selected colour must be added to the article code. E.g.: PLS... 30A (chosen finish anod. silver) PLSAA 30A.

**ANODIZED ALUMINIUM with adhesive thermo packed** - bar length 0,83 lm - pack. 20 Pcs



Article	Width-thick.		
PLSAA 308AS	30 mm - 10/10		

On demand 0,73 or 0,63 lm bar length (quantity and prices to be agreed. Production delay 4/5 weeks).

**ANODIZED ALUMINIUM with adhesive thermo packed** - bar length 0,93 lm - pack. 20 Pcs



Article	Width-thick.		
PLS... 309AS	30 mm - 10/10		

**ANODIZED ALUMINIUM with adhesive thermo packed** - bar length 1,03 lm - pack. 20 Pcs



Article	Width-thick.		
PLS... 3010AS	30 mm - 10/10		

**ANODIZED ALUMINIUM with adhesive thermo packed** - bar length 1,66 lm - pack. 20 Pcs



Article	Width-thick.		
PLSAA 3016AS	30 mm - 10/10		

**ANODIZED ALUMINIUM with adhesive thermo packed** - bar length 0,93 lm - pack. 20 Pcs



Article	Width-thick.		
PLS... 309A	30 mm - 10/10		

Available in the colours: AA - AO (AB, AT, CH and SB available on demand with a minimum quantity order of 100 pcs). The code of the selected colour must be added to the article code. E.g.: PLS... 309A (chosen finish anod. silver) PLSAA 309A.

## COLOURS

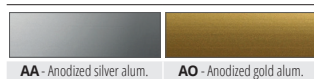

## ON DEMAND MINIMUM 100 PCS by color and height



(Prices to be agreed. Production delay 4/5 weeks)

PLS... 30A/309A/308AS/309AS/3010AS/3016AS

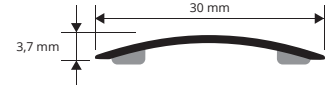

PLS... 35A

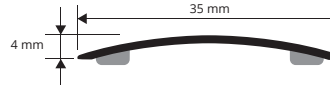

PLS... 40A

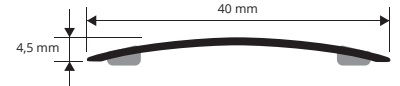

PLS... 30F/309F/308FS/309FS/3016FS

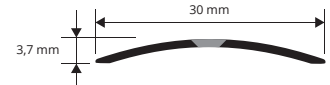

PLS... 35F

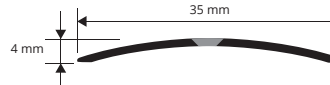

PLS... 40F

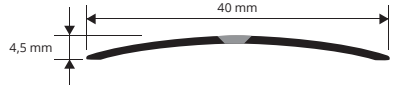

threshold - joint-cover profiles

## EXAMPLES AND INSTRUCTIONS FOR LAYING METHODS

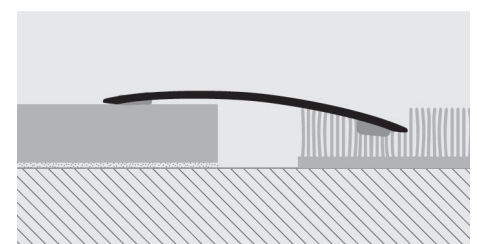
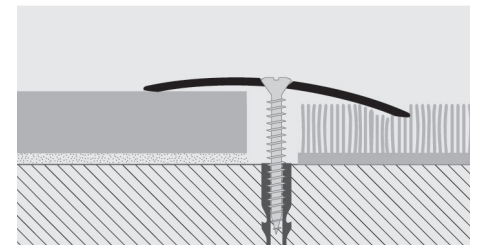
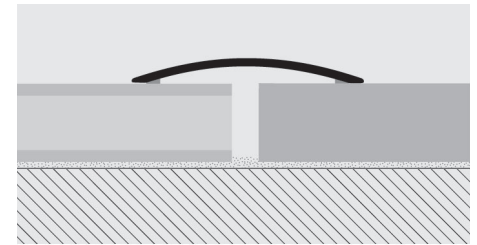

1. Choose the suitable profile and cut it to the necessary length.
- Adhesive version**
2. Degrease, wash and clean the solid surface thoroughly.
3. Remove the protective paper from the adhesive.
4. Lay the profile by applying pressure evenly over the whole surface without using a hammer.
- Punched version**
2. Mark the position of the holes using the existing holes in the profile as reference.
3. Insert the screw anchors into the drilled holes.
4. Fix the profile using flathead screws suitable for the relative slots in the profile.

\* = Production on demand with minimum quantity of 100 pcs. Production delay 4/5 weeks. Price to be agreed





**PROLEVALL 25-35-38-50** are joint - covers in anodized aluminium with gold, silver and bronze finish in various widths with a more or less knurled flat surface, available with self-adhesive backing or punched in various lengths. They are used to join floors of the same or differing material e.g. ceramic tiles, wood, marble, parquet or laminated, mainly to cover flaws created during laying or expansion joints. The chamfered edges ensure perfect adhesion to the floor, while the flat top allows perfect door closure. Recommended for dwellings and public environments with intense pedestrian traffic. Easy to lay; the high-strength elastomer adhesive ensures an excellent grip.

# PROLEVALL 25-35-38-50

ANODIZED GOLD AND SILVER  
ALUMINIUM WITH SELF-ADHESIVE AND PUNCHED



**ANODIZED ALUMINIUM with adhesive thermo packed**  
bar length 2,7 lm - pack. 40 Pcs - 108 lm

Article	Width mm		
PLV... 25A	25		
PLV... 35A	35		
PLV... 38A	38		
PLV... 50A	50		

Available in the colours: AA - AO (AB, AT, CH and SB available on demand with a minimum quantity order of 100 pcs). The code of the selected colour must be added to the article code. E.g.: PLV... 25A (chosen finish anod. silver) PLVAA 25A.

**ANODIZED ALUMINIUM with adhesive thermo packed** - bar length 0,93 lm - pack. 20 Pcs



Article	Width mm		
PLV... 259AS	25		
PLV... 359AS	35		
PLV... 389AS	38		
PLV... 509AS	50		*

Available in the colours: AA - AO (AB, AT, CH and SB available on demand with a minimum quantity order of 100 pcs). The code of the selected colour must be added to the article code. E.g.: PLV... 259AS (chosen finish anod. silver) PLVAA 259AS.

**ANODIZED ALUMINIUM with adhesive thermo packed** - bar length 1,03 lm - pack. 20 Pcs



Article	Width mm		
PLV... 3510AS	35		*

**ANODIZED ALUMINIUM with adhesive thermo packed** - bar length 1,66 lm - pack. 20 Pcs



Article	Width mm		
PLV... 3516AS	35		*

The code of the selected colour must be added to the article code. E.g.: PLV... 3510AS (chosen colour anodized gold alum.) PLVAA 3510AS.

## COLOURS

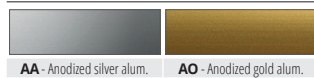

## ON DEMAND MINIMUM 100 PCS by color and height



(Prices to be agreed. Production delay 4/5 weeks)

**ANODIZED ALUMINIUM punched thermo packed**  
bar length 2,7 lm - pack. 40 Pcs - 108 lm

Article	Width mm		
PLV... 25F	25		
PLV... 35F	35		
PLV... 38F	38		
PLV... 50F	50		

Available in the colours: AA - AO (AB, AT, CH and SB available on demand with a minimum quantity order of 100 pcs). The code of the selected colour must be added to the article code. E.g.: PLV... 25F (chosen finish anod. silver) PLVAA 25F.

## OFF-CENTRE HOLES ON DEMAND

**ANODIZED ALUM. punched with screws and screw anchors thermo packed** - bar length 0,93 lm - pack. 20 Pcs



Article	Width mm		
PLV... 259FS	25		
PLV... 359FS	35		
PLV... 389FS	38		
PLV... 509FS	50		*

PLV... 259FS-359FS available in the colours: AA - AO (AB, AT, CH and SB available on demand with a minimum quantity order of 100 pcs). The code of the selected colour must be added to the article code. E.g.: PLV... 359FS (chosen finish anod. silver) PLVAA 359FS.

**ANODIZED ALUM. punched with screws and screw anchors thermo packed** - bar length 1,03 lm - pack. 20 Pcs



Article	Width mm		
PLV... 3510FS	35		*

**ANODIZED ALUM. punched with screws and screw anchors thermo packed** - bar length 1,66 lm - pack. 20 Pcs



Article	Width mm		
PLV... 3516FS	35		*

PLV... 25A  
PLV... 259A

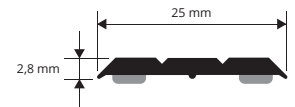

PLV... 35A  
PLV... 359A  
PLV... 3510A  
PLV... 3516A



PLV... 38A  
PLV... 389A

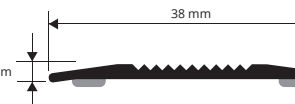

PLV... 50A  
PLV... 509A



PLV... 25F  
PLV... 259F

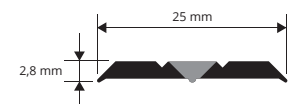

PLV... 35F  
PLV... 359F  
PLV... 3510F  
PLV... 3516F

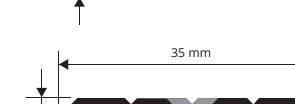

PLV... 38F  
PLV... 389F

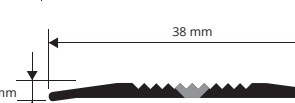

PLV... 50F  
PLV... 509F



## EXAMPLES AND INSTRUCTIONS FOR LAYING METHODS

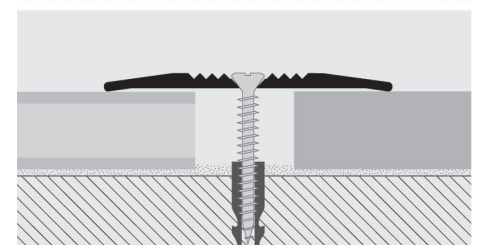
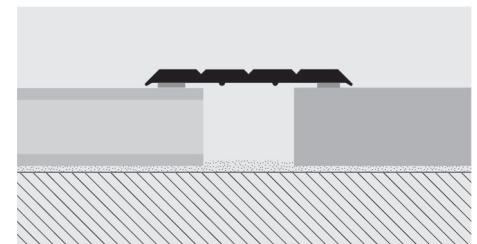
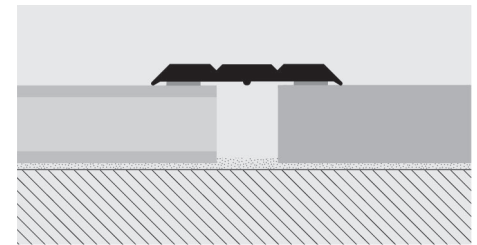

1. Choose the suitable profile and cut it to the necessary length.

### Adhesive version

2. Degrease, wash and clean the solid surface thoroughly. 3. Remove the protective paper from the adhesive. 4. Lay the profile by applying pressure evenly over the whole surface without using a hammer.

### Punched version

2. Mark the position of the holes using the existing holes in the profile as reference. 3. Insert the screw anchors into the drilled holes. 4. Fix the profile using flathead screws suitable for the relative slots in the profile.

\* = Production on demand with minimum quantity of 100 pcs. Production delay 4/5 weeks. Price to be agreed



# PROMOQUETTE

ANODIZED GOLD AND SILVER ALUMINIUM WITH OR WITHOUT SELF-ADHESIVE

**PROMOQUETTE** is an anodized aluminium rounded edging profile with tap-down edge, which is ideal for the clean-cut, elegant finishing of carpeted floors. The carpeting is inserted inside the curved/rounded section, which is then pressed down until the carpeting is secured, thereby also protecting the edge. **PROMOQUETTE** ensures a perfect finish, covering any flaws created during laying and protecting the edge. Easy to lay with the self-adhesive backing ensuring perfect adherence to the floor.

carpet gripper profiles

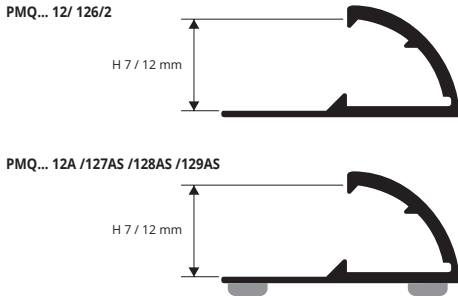

## EXAMPLES AND INSTRUCTIONS FOR LAYING METHODS

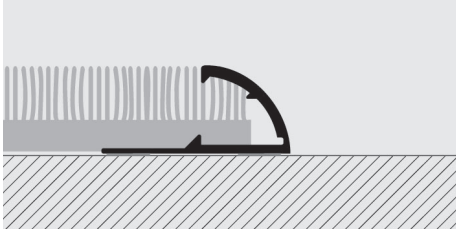

1. Cut the profile to the necessary length.
2. Fix the "PROMOQUETTE" to the floor using screws/nails or double-sided adhesive tape.
3. Insert the carpeting into the curved side with the necessary tension.
4. Apply pressure evenly over the edge of the profile until it closes over and secures the carpeting.

**ANODIZED GOLD and SILVER ALUMINIUM ADHESIVE thermo packed** - bar length 2,7 lm - pack. 40 Pcs - 108 lm

Article	H mm		
PMQ... 12A	7/12		
PMQ... 12	7/12		

"A" at the end of the product code = Item with adhesive  
Available in the colours: AA - AO. (AB available on demand with a minimum quantity order of 100 pcs). The code of the selected colour must be added to the article code. E.g.: PMQ... 12A (chosen colour Anodized gold alum.) PMQAO 12A.

**ANODIZED GOLD and SILVER ALUMINIUM thermo packed** - bar length 0,67 lm - pack. 2 Pcs

Article	H mm		
PMQ... 126/2	7/12		

**ANODIZED SILVER ALUMINIUM ADHESIVE thermo packed** - bar length 0,73 lm - pack. 20 Pcs

Article	H mm		
PMQAA 127AS	7/12		*

**ANODIZED GOLD, SILVER and BRONZE ALUM. ADHESIVE thermo packed** - bar length 0,83 lm - pack. 20 Pcs

Article	H mm		
PMQ... 128AS	7/12		*

**ANODIZED GOLD, SILVER and BRONZE ALUM. ADHESIVE thermo packed** - bar length 0,93 lm - pack. 20 Pcs

Article	H mm		
PMQ... 129AS	7/12		*

## COLOURS



**ON DEMAND MINIMUM 100 PCS** by color and height

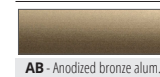

(Prices to be agreed. Production delay 4/5 weeks)

# PROMOQUETTE FIX

ANODIZED GOLD AND SILVER ALUMINIUM PUNCHED OR NOTCHED

**PROMOQUETTE FIX** is a profile in anodized aluminium made as a terminal profile to edge carpeted floors held under tension or simply laid with double-sided adhesive tape. Two versions are available: notched or with holes/notches for laying under tension and then permanently fixed with screws/nails; or the punched version to edge without holding under tension. **PROMOQUETTE FIX** ensures an impeccable finish to the edge of carpeting that is not always perfectly cut. It speeds up laying time and the result is attractive.

carpet gripper profiles

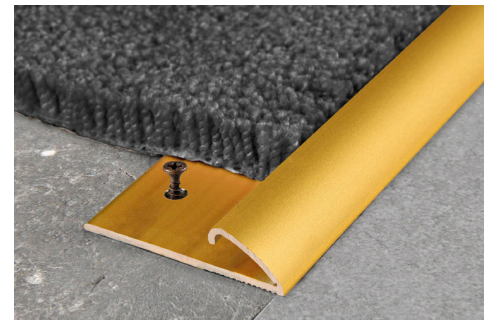
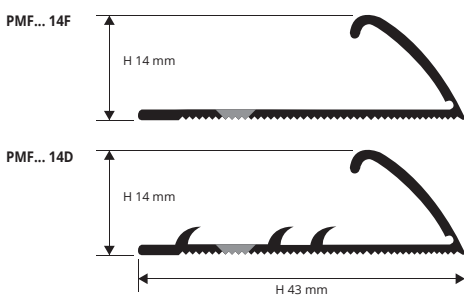

## EXAMPLES OF LAYING

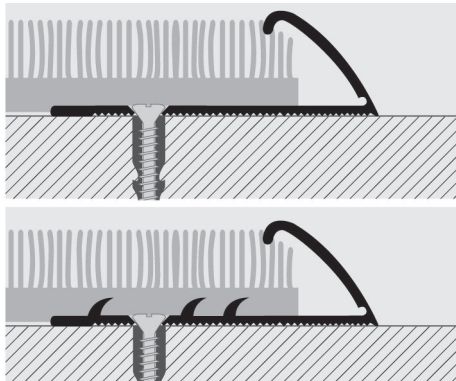

**ANODIZED GOLD and SILVER ALUMINIUM thermo packed** - bar length 2,7 lm - pack. 20 Pcs - 54 lm

Article	H mm		
PMF... 14F	14		
PMFAA 14D	14		*

"D" at the end of the product code = Item with notched  
"F" at the end of the product code = Punched Item

Available in the colours: AO - AA. (AB available on demand with a minimum quantity order of 100 pcs). The code of the selected colour must be added to the article code. E.g.: PMF... 14F (chosen colour anodized gold alum.) PMFAO 14F.

## COLOURS

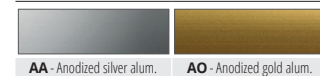

**ON DEMAND MINIMUM 100 PCS** by color and height

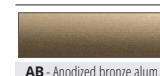

(Prices to be agreed. Production delay 4/5 weeks)

## INSTRUCTIONS FOR LAYING

1. Cut the profile to the necessary length.
2. Fix the "PROMOQUETTE FIX" to the floor using screws/nails.
3. Insert the carpeting into the curved side with the necessary tension.
4. Apply pressure evenly over the edge of the profile until it closes over and secures the carpeting.

\* = Production on demand with minimum quantity of 100 pcs. Production delay 4/5 weeks. Price to be agreed



**PROMOQUETTE GIN** is a profile in anodized aluminium with tap-down edge for edging or joining floors in carpeting, PVC, linoleum, ceramic tiles/wood, etc. Two versions are available: punched for laying under tension and then permanently fixed with screws/nails or the adhesive version for laying with glue and which can be taken up if required. **PROMOQUETTE GIN** guarantees an impeccable finish and offers the dual function of both joining and of covering any flawed edges of the floors. It speeds up laying time and the result is attractive.

## PROMOQUETTE GIN

ANODIZED GOLD, SILVER AND BRONZE ALUMINIUM WITH SELF-ADHESIVE AND PUNCHED



**ANODIZED GOLD, SILVER AND BRONZE ALUMINIUM ADHESIVE thermo packed** - bar length 2,7 lm - pack. 20 Pcs - 54 lm

Article	H mm
PMGAA 813A	8/13
PMGAO 813A	8/13
PMGAB 813A	8/13
PMGAT 813A	8/13
PMGCH 813A	8/13
PMGSB 813A	8/13

Available in the colours: AO - AA - AB (AT, CH and SB available on demand with a minimum quantity order of 100 pcs). The code of the selected colour must be added to the article code. E.g.: PMG... 813F (chosen colour anodized gold alum.) PMGAO 813F.



**ANODIZED GOLD, SILVER AND BRONZE ALUMINIUM PUNCHED thermo packed** - bar length 2,7 lm - pack. 20 Pcs - 54 lm

Article	H mm
PMGAA 813F	8/13
PMGAO 813F	8/13
PMGAB 813F	8/13
PMGAT 813F	8/13
PMGCH 813F	8/13
PMGSB 813F	8/13

### COLOURS

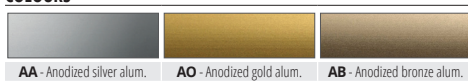

ON DEMAND MINIMUM 100 PCS by color and height



(Prices to be agreed. Production delay 4/5 weeks)

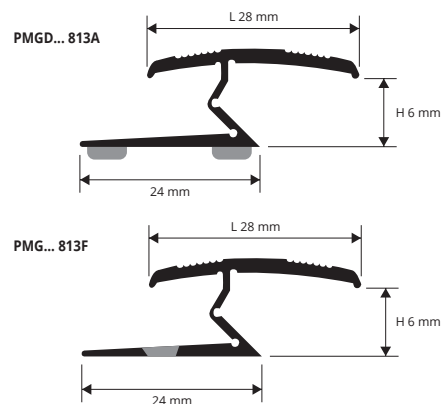

carpet gripper profiles

### EXAMPLES AND INSTRUCTIONS FOR LAYING METHODS

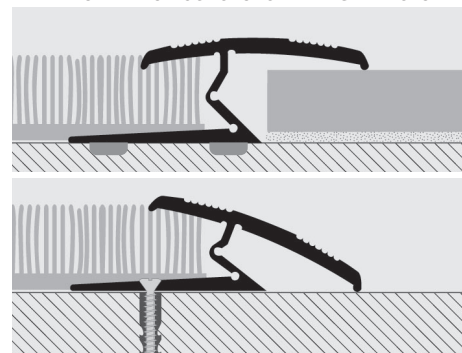

1. Cut the profile to the necessary length. 2. Fix the "PROMOQUETTE GIN" to the floor using screws/nails or two-sided adhesive tape. 3. Lay the required floor, inserting the carpeting, PVC, linoleum, ceramic tile or wood under the upper curved part. 4. Apply pressure evenly on the edges of the profile until they close and secure the flooring on both sides.

**PROMOQUETTE CLIP** is an aluminum profile, which allows to combine two carpet in practical and fast way. The profile is composed by a base and a TOP serrated, thanks to its particular section, allows to cover and fix the edges of the carpet with the connection of the top to the base. **PROMOQUETTE CLIP** in anodized aluminum is suitable for closed environment is required where a good resistance to mechanical and chemical stresses.

## PROMOQUETTE CLIP

ANODIZED SILVER ALUMINIUM TOP AND NOTCHED BASE



### COLOURS



**ANODIZED SILVER ALUMINIUM thermo packed**  
bar length 2,7 lm - pack. 20 Pcs - 54 lm

Article	H mm
PMCAA 525D	5

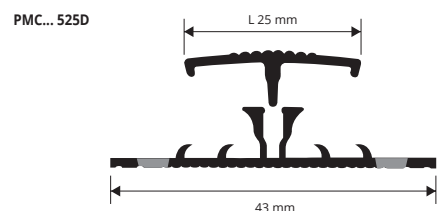

carpet gripper profiles

### EXAMPLES AND INSTRUCTIONS FOR LAYING METHODS

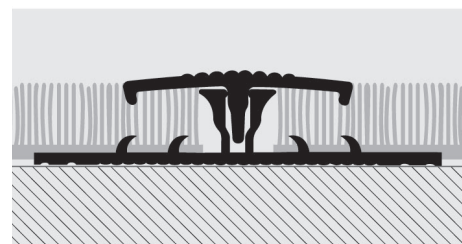

1. Cut the profile to the necessary length. 2. Fix the punched/notched base to the floor using screws/nails or two-sided adhesive tape. 3. Lay the carpeting by gluing or holding under tension. 4. With the help of a wooden tapping block and a hammer, apply pressure evenly over the whole of the top profile until it clicks into the base, thereby securing the carpeting on both sides.

\* = Production on demand with minimum quantity of 100 pcs. Production delay 4/5 weeks. Price to be agreed

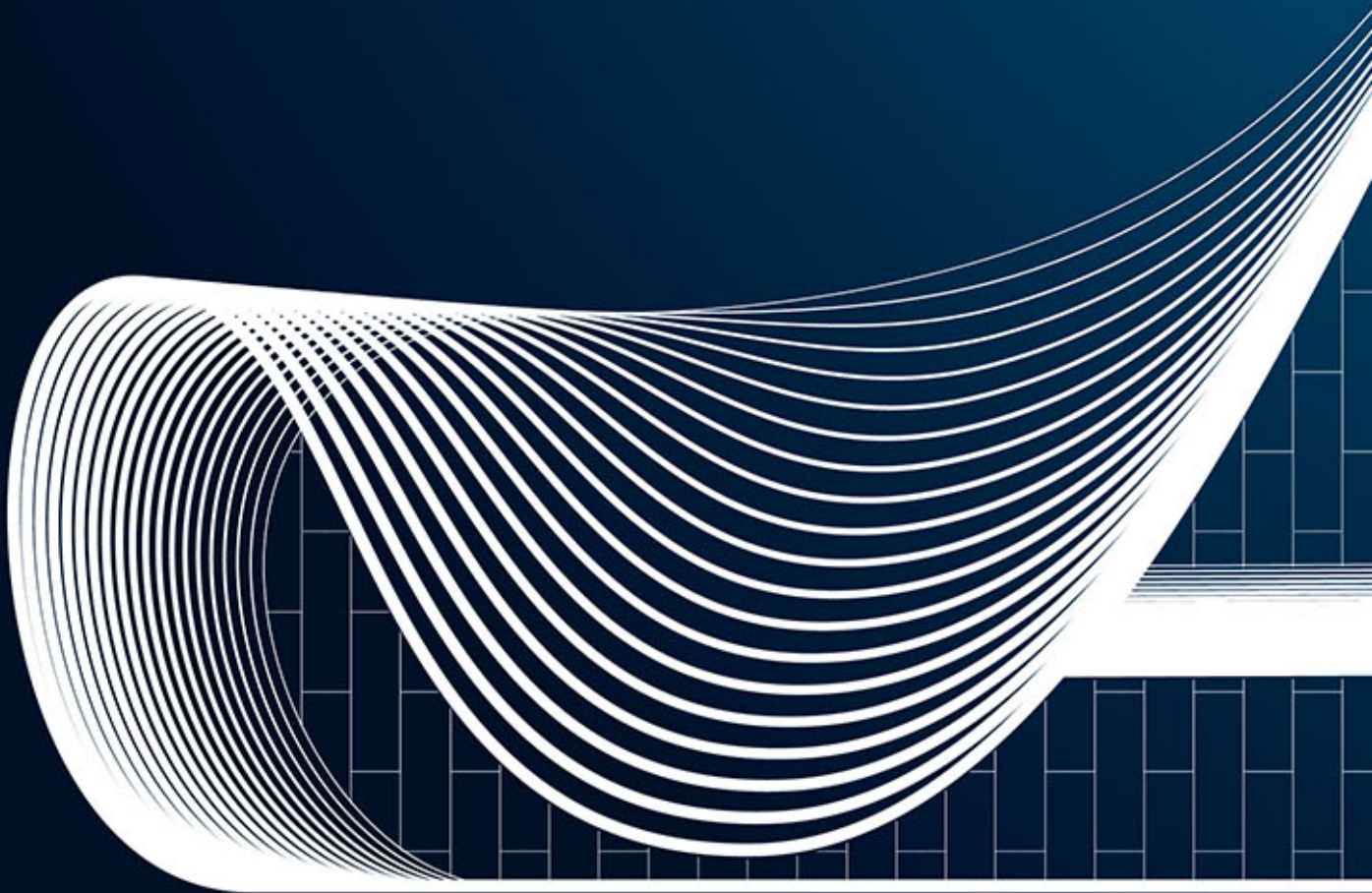

An interpretation of:  
**Heydar Aliyev Cultural Center, Zaha Hadid, BAKU (Azerbaijan), 2012**

CURVE AND BENDABLE PROFILES

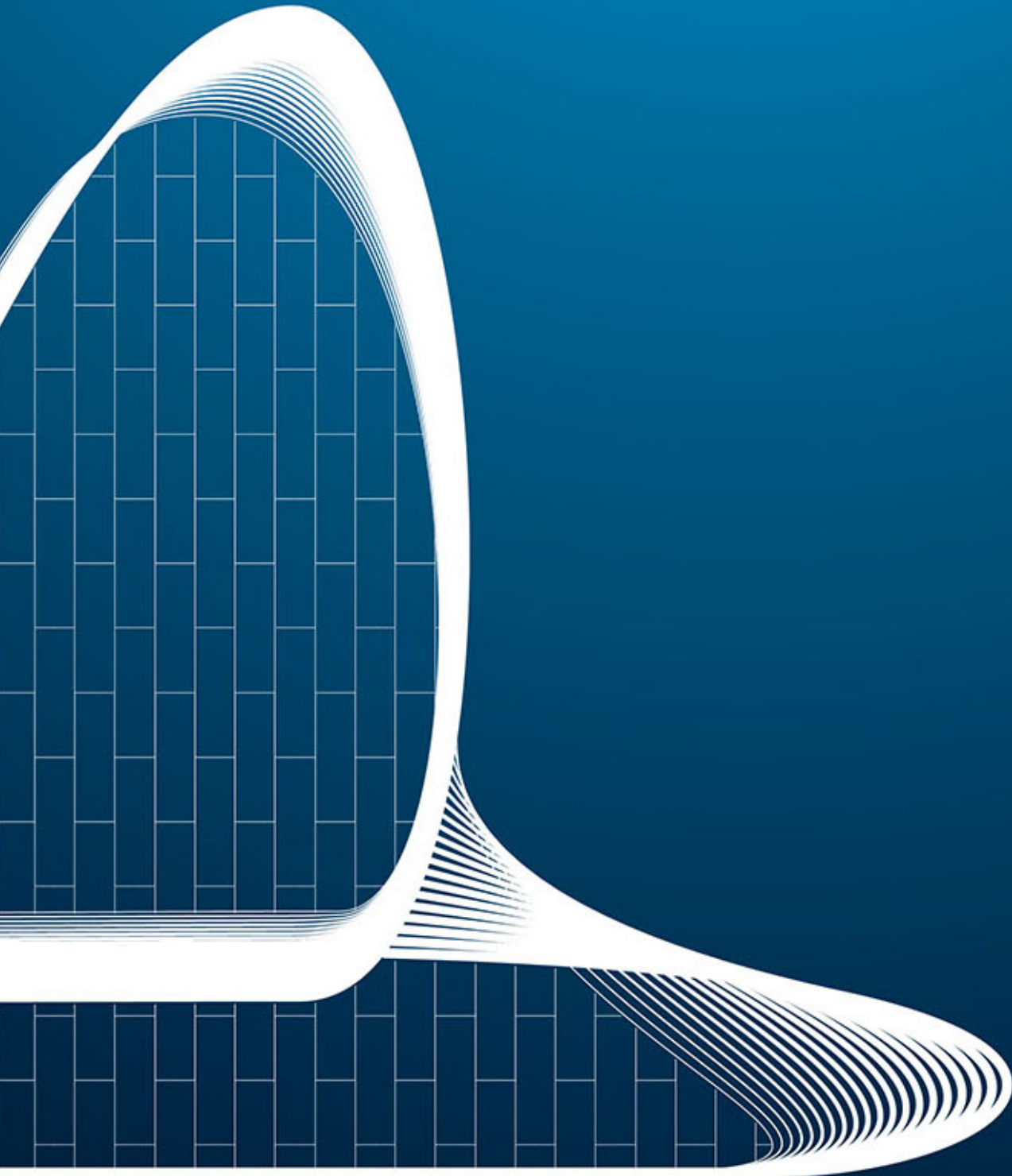



# PRO CURVE LINE

PRO CURVE LINE are a range of profiles that may be curved/shaped, with a special system of perforations allowing them to be bent so that particular geometric shapes may be easily obtained in situ. This allows decorative patterns to be created at will according to technical and aesthetic requirements. The profiles in the PRO CURVE LINE may be used as transition or edging profiles or to create joining and expansion joints on any type of ceramic, parquet, wood, laminate/melamine coated wood, marble, carpeted, Palladian, Venetian floor, etc. The profiles are made in AISI 304/1.4301-V2A stainless steel, aluminium and brass and may be easily shaped by using the PROCURVE MACHINE to bend the profiles mechanically.



## PROTERMINAL CURVE

STAINLESS STEEL AISI 304/1.4301-V2A  
CURVABLE

PROTERMINAL CURVE are a range of edging and joining profiles that may be curved/shaped, with a special system of perforations allowing them to be bent so that particular geometric shapes may be easily obtained in situ. This allows decorative patterns to be created at will according to technical and aesthetic requirements and with a separation of 3 mm. The product is made in stainless steel AISI 304/1.4301-V2A in various heights (6, 8, 10, 12,5, 15 and 20 mm) in 2.7 m bars.

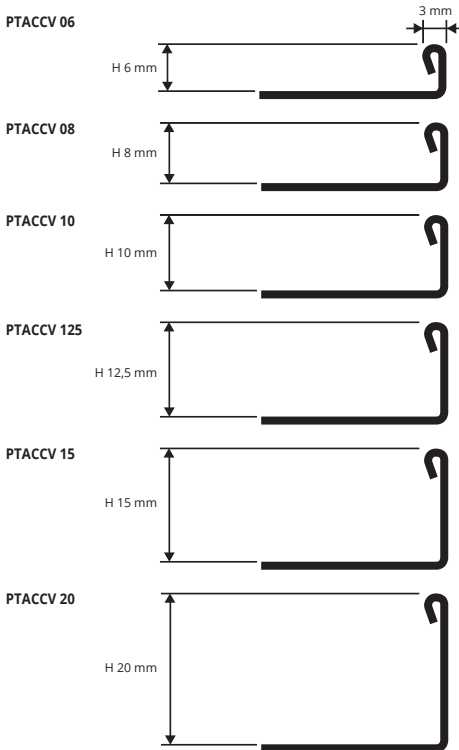

POLISHED STAINLESS STEEL AISI 304/1.4301-V2A with protective film  
bar length 2,7 lm - pack 20 Pcs - 54 lm - 10/10 mm

Article	H mm		
PTACCV 06	6		
PTACCV 08	8		
PTACCV 10	10		
PTACCV 125	12,5		
PTACCV 15	15		
PTACCV 20	20		

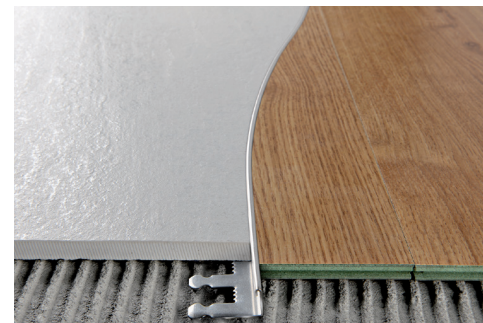

### COLOURS



### EXAMPLES OF LAYING

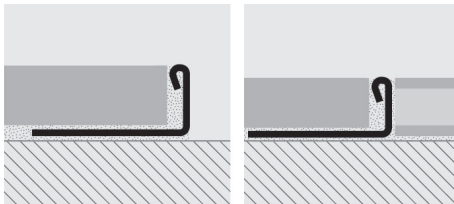

### LAYING INSTRUCTIONS

1. Choose the "PROTERMINAL CURVE" with the required height and material. 2. Cut the profile to the necessary length, calculating the total length. 3. Bend the profile mechanically with the PROCURVE MACHINE. 4. If necessary fix with screws and screw anchors or simply insert the punched base under the floor laid with the same adhesive. If it is used as a joining profile, bring each floor to the edge of the profile.

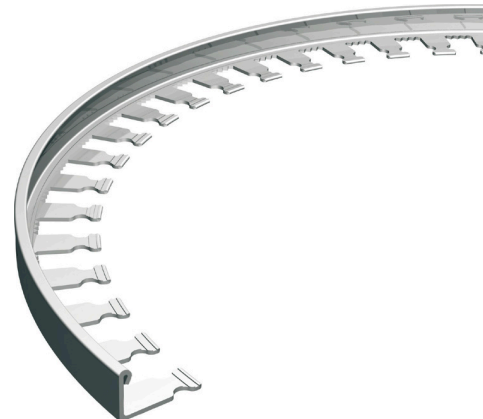

SUITABLE FOR USE IN CONTACT WITH FOODSTUFFS



**PROTERMINAL CURVE** are a range of edging and joining profiles that may be curved/shaped. They feature a special system of perforations allowing them to be bent easily so that particular geometric shapes may be easily obtained in situ. This allows decorative patterns to be created at will according to technical and aesthetic requirements and with a separation of 3 mm of sandable profile. The product is made in natural brass in 2.7 m bars and heights of 6, 8, 10, 12.5, 15 and 20 mm.

# PROTERMINAL CURVE

NATURAL BRASS CURVABLE

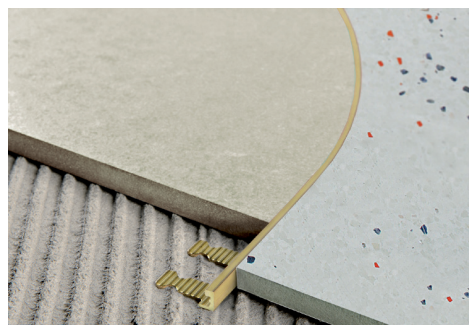
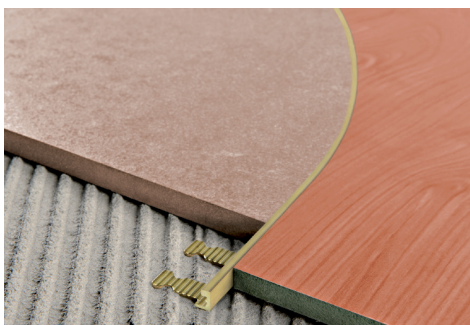

**NATURAL BRASS CURVABLE thermo packed 10pcs**  
bar length 2,7 lm - pack. 40 Pcs - 108 lm (H:15; 20 mm - 54 lm)

Article	H mm
PTONCV 06	6
PTONCV 08	8
PTONCV 10	10
PTONCV 125	12,5
PTONCV 15	15
PTONCV 20	20

#### COLOURS



#### EXAMPLES AND INSTRUCTIONS FOR LAYING METHODS

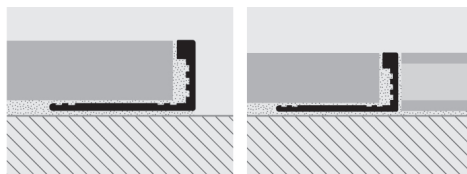

1. Choose the "PROTERMINAL CURVE" in the required height and material. 2. Cut the profile to the necessary length, calculating the total length. 3. Bend the profile mechanically with the PROCURVE MACHINE. 4. If necessary fix with screws and screw anchors or simply insert the punched base under the floor laid with the same adhesive. Any oxidation marks may be easily removed with specific chemical products (Sidol-Smac, etc.). If it is used as a joining profile, bring each floor to the edge of the profile.

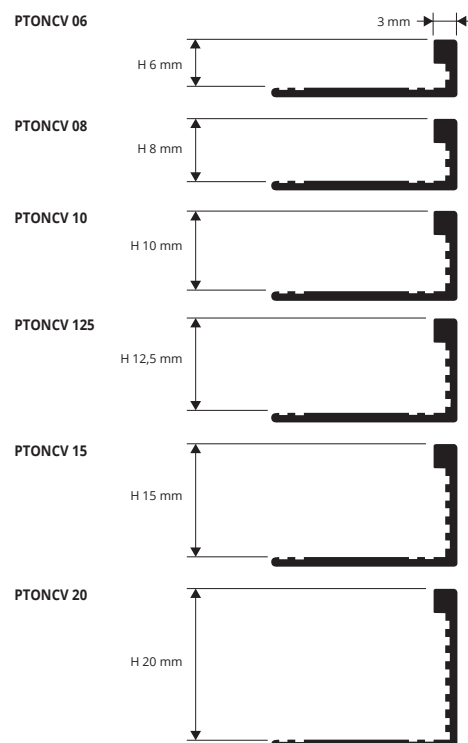

**PROTERMINAL CURVE** are a range of edging and joining profiles that may be curved/shaped. They feature a special system of perforations allowing them to be bent easily so that particular geometric shapes may be easily obtained in situ. This allows decorative patterns to be created at will according to technical and aesthetic requirements and with a separation of 3 mm of sandable profile. The product is made in natural aluminium in 2.7 m bars and heights of 6, 8, 10, 12.5, 15 and 20 mm.

# PROTERMINAL CURVE

NATURAL ALUMINIUM CURVABLE

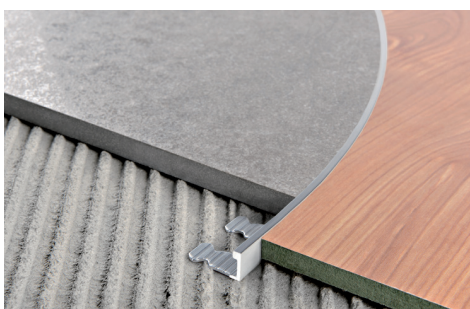

**NATURAL ALUMINIUM CURVABLE thermo packed 10 Pcs**  
bar length 2,7 lm - pack. 40 Pcs - 108 lm

Article	H mm
PTANCV 06	6
PTANCV 08	8
PTANCV 10	10
PTANCV 125	12,5
PTANCV 15	15
PTANCV 20	20

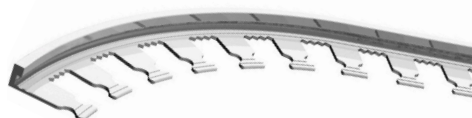

#### EXAMPLES OF LAYING (for laying instructions, see above)

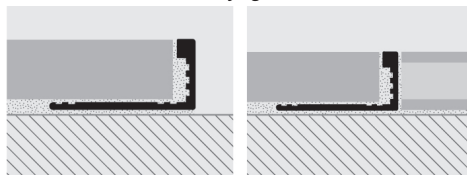

#### COLOURS

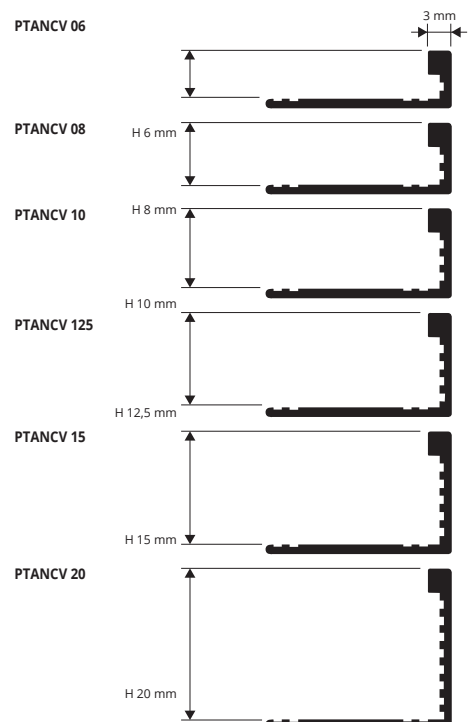

\* = Production on demand with minimum quantity of 100 pcs. Production delay 4/5 weeks. Price to be agreed



**PROELEGANT CURVE** are a range of edging and joining profiles that may be curved/shaped. They feature a special system of perforations allowing them to be bent easily so that particular geometric shapes may be easily obtained in situ. This allows decorative patterns to be created at will according to technical and aesthetic requirements and with a separation of 6 mm of sandable profile. The product is made in natural brass in 2.7 m bars and heights of 8-10-12.5 and 14 mm.

## PROELEGANT CURVE

NATURAL BRASS CURVABLE

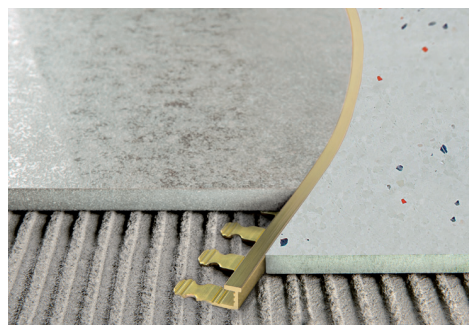
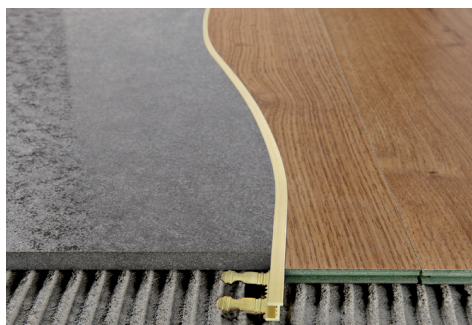

**NATURAL BRASS CURVABLE thermo packed 5 Pcs**  
bar length 2,7 lm - pack. 20 Pcs - 54 lm

Article	H mm		
PELONCV 08	8		
PELONCV 10	10		
PELONCV 125	12,5		
PELONCV 14	14		

### COLOURS

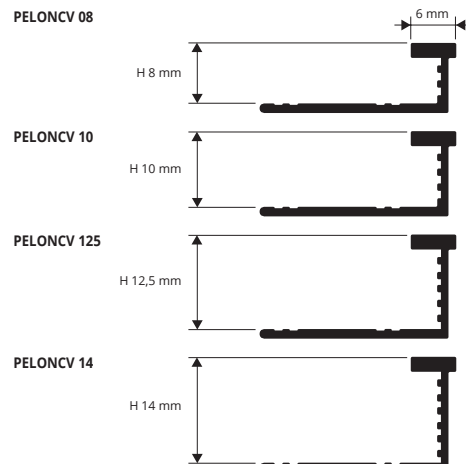

### EXAMPLES AND INSTRUCTIONS FOR LAYING METHODS

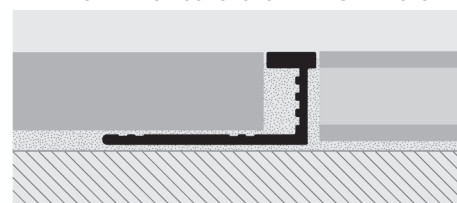

1. Choose the "PROELEGANT CURVE" in the required height and material. 2. Cut the profile to the necessary length, calculating the total length. 3. Bend the profile mechanically with the PROCURVE MACHINE. 4. If necessary fix with screws and screw anchors or simply insert the punched base under the floor laid with the same adhesive. Any oxidation marks may be easily removed with specific chemical products (Sidol-Smac, etc.).

**PROELEGANT CURVE** are a range of edging and joining profiles that may be curved/shaped. They feature a special system of perforations allowing them to be bent easily so that particular geometric shapes may be easily obtained in situ. This allows decorative patterns to be created at will according to technical and aesthetic requirements and with a separation of 6 mm of sandable profile. The product is made in silver anodized aluminium in 2.7 m bars and heights of 8-10-12.5 mm.

## PROELEGANT CURVE

ANODIZED SILVER ALUMINIUM CURVABLE

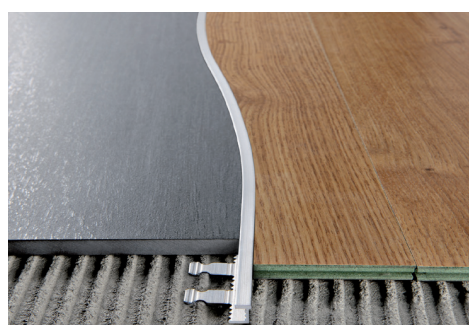

**ANODIZED SILVER ALUMINIUM CURVABLE thermo packed**  
bar length 2,7 lm - pack. 20 Pcs - 54 lm

Article	H mm		
PELAACV 08	8		
PELAACV 10	10		
PELAACV 125	12,5		

### COLOURS

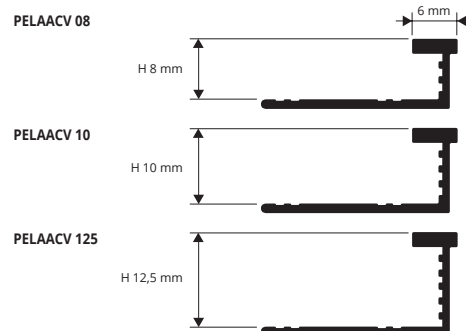

### EXAMPLES AND INSTRUCTIONS FOR LAYING METHODS

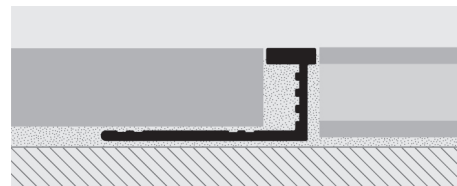

1. Choose the "PROELEGANT CURVE" in the required height and material. 2. Cut the profile to the necessary length, calculating the total length. 3. Bend the profile mechanically with the PROCURVE MACHINE. 4. If necessary fix with screws and screw anchors or simply insert the punched base under the floor laid with the same adhesive. Any oxidation marks may be easily removed with specific chemical products (Sidol-Smac, etc.).

\* = Production on demand with minimum quantity of 100 pcs. Production delay 4/5 weeks. Price to be agreed



# PROFINAL CURVE

NATURAL BRASS  
CURVABLE

**PROFINAL CURVE** are a range of edging and joining profiles that may be curved/shaped. They feature a special system of perforations allowing them to be bent easily so that particular geometric shapes may be easily obtained in situ. This allows decorative patterns to be created at will according to technical and aesthetic requirements and with a separation of 8 mm of sandable profile. The product is made in natural brass in 2.7 m bars and heights of 8, 10 and 12.5 mm.

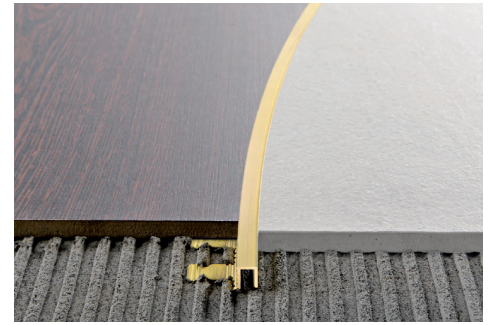
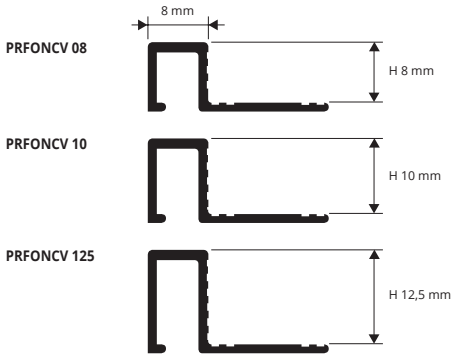

**NATURAL BRASS CURVABLE** thermo packed 5 Pcs  
bar length 2,7 lm - pack. 20 Pcs - 54 lm

Article	H mm		
PRFONCV 08	8		
PRFONCV 10	10		
PRFONCV 125	12,5		

**COLOURS**

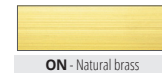

## EXAMPLES AND INSTRUCTIONS FOR LAYING METHODS

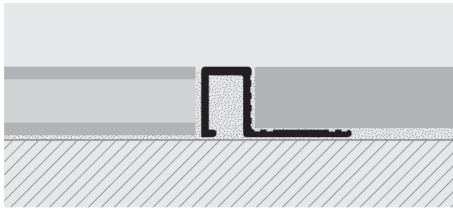

1. Choose the "PROFINAL CURVE" in the required height and material. 2. Cut the profile to the necessary length, calculating the total length. 3. Bend the profile mechanically with the PROCURVE MACHINE. 4. If necessary fix with screws and screw anchors or simply insert the punched base under the floor laid with the same adhesive. Any oxidation marks may be easily removed with specific chemical products (Sidel-Smac, etc.). If it is used as a joining profile, bring each floor to the edge of the profile.

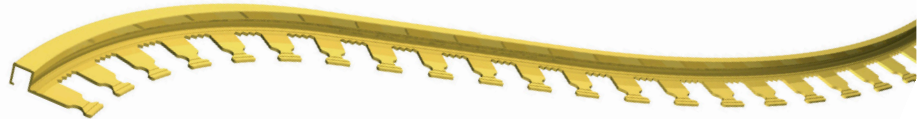

# PROFINAL CURVE

ANODIZED SILVER ALUMINIUM  
CURVABLE

**PROFINAL CURVE** are a range of edging and joining profiles that may be curved/shaped. They feature a special system of perforations allowing them to be bent easily so that particular geometric shapes may be easily obtained in situ. This allows decorative patterns to be created at will according to technical and aesthetic requirements and with a separation of 8 mm of sandable profile. The product is made in silver anodized aluminium in 2.7 m bars and heights of 8, 10 and 12.5 mm.

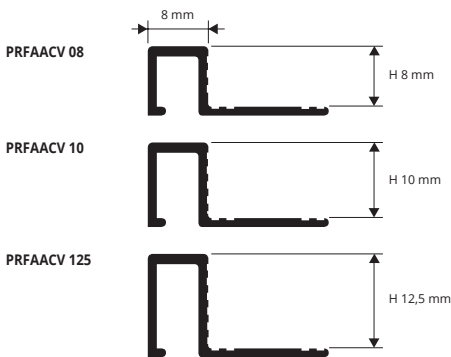

**ANODIZED SILVER ALUMINIUM CURVABLE**  
thermo packed - bar length 2,7 lm - pack. 20 Pcs - 54 lm

Article	H mm		
PRFAACV 08	8		
PRFAACV 10	10		
PRFAACV 125	12,5		

**COLOURS**



## EXAMPLES AND INSTRUCTIONS FOR LAYING METHODS

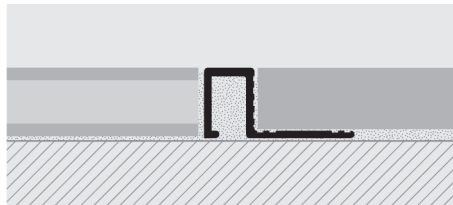

1. Choose the "PROFINAL CURVE" in the required height and material. 2. Cut the profile to the necessary length, calculating the total length. 3. Bend the profile mechanically with the PROCURVE MACHINE. 4. If necessary fix with screws and screw anchors or simply insert the punched base under the floor laid with the same adhesive. Any oxidation marks may be easily removed with specific chemical products (Sidel-Smac, etc.). If it is used as a joining profile, bring each floor to the edge of the profile.



\* = Production on demand with minimum quantity of 100 pcs. Production delay 4/5 weeks. Price to be agreed



**PROJOLLY CURVE** is a range of terminal transition profiles that may be curved/shaped, with a special system of perforations allowing it to be bent so that particular geometric shapes may be easily obtained in situ. This allows decorative patterns to be created at will according to technical and aesthetic requirements. It is made in natural brass, height H 8 - H 10mm, length 2.7 lm.

# PROJOLLY CURVE

NATURAL BRASS CURVABLE

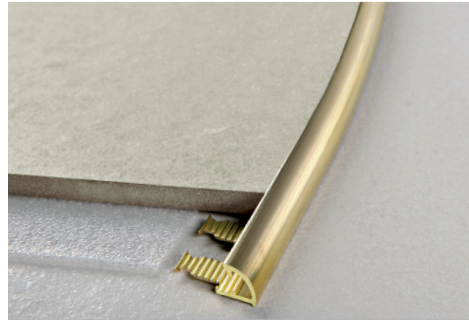

**NATURAL BRASS CURVABLE** thermo packed 5 Pcs  
bar length 2,7 lm - pack: 20 Pcs - 54 lm

Article	H mm		
PJONCV 08	8		
PJONCV 10	10		

### COLOURS



PJONCV 08



PJONCV 10



### EXAMPLES AND INSTRUCTIONS FOR LAYING METHODS

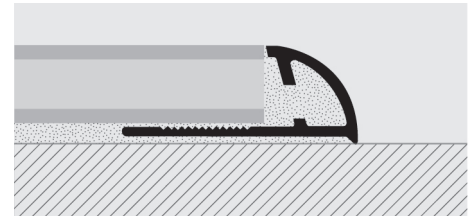

1. Choose the "PROJOLLY CURVE" in the required height and material.
2. Cut the profile to the necessary length, calculating the total length.
3. Bend the profile mechanically with the PROCURVE MACHINE.
4. If necessary fix with screws and screw anchors or simply insert the punched base under the floor laid with the same adhesive.

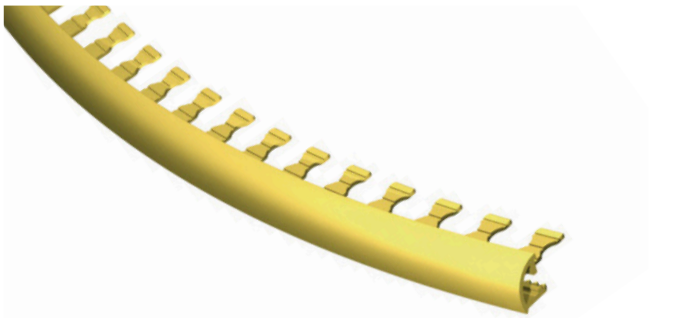

**PROJOLLY CURVE** is a range of terminal transition profiles that may be curved/shaped, with a special system of perforations allowing it to be bent so that particular geometric shapes may be easily obtained in situ. This allows decorative patterns to be created at will according to technical and aesthetic requirements. It is made in anodized aluminium, height H 8 -H 10mm, length 2.7 lm.

# PROJOLLY CURVE

ANODIZED SILVER ALUMINIUM CURVABLE



**ANODIZED SILVER ALUMINIUM CURVABLE** thermo packed  
bar length 2,7 lm - pack: 20 Pcs - 54 lm

Article	H mm		
PJAACV 08	8		
PJAACV 10	10		

### COLOURS

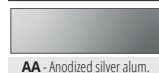

PJAACV 08



PJAACV 10



### EXAMPLES AND INSTRUCTIONS FOR LAYING METHODS

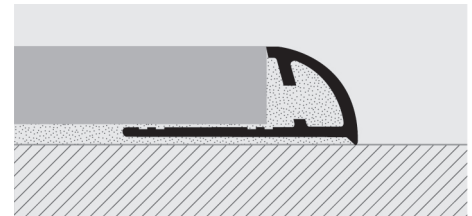

1. Choose the "PROJOLLY CURVE" in the required height and material.
2. Cut the profile to the necessary length, calculating the total length.
3. Bend the profile mechanically with the PROCURVE MACHINE.
4. If necessary fix with screws and screw anchors or simply insert the punched base under the floor laid with the same adhesive.

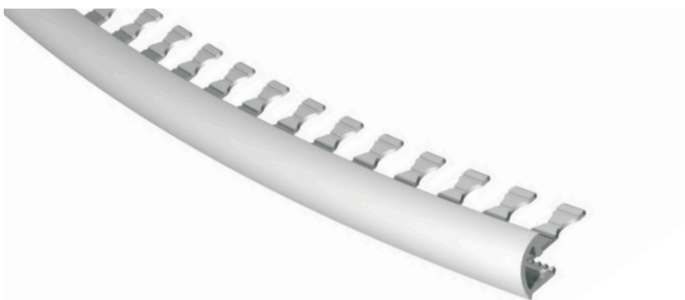

\* = Production on demand with minimum quantity of 100 pcs. Production delay 4/5 weeks. Price to be agreed



# TERMINAL CURVE

ANODIZED SILVER ALUMINIUM AND 10 WOOD FINISHES - CURVABLE

**TERMINAL CURVE** is a range of edging and joining profiles that may be curved/shaped, with a special system of perforations allowing it to be bent so that particular geometric shapes may be easily obtained in situ. This allows decorative patterns to be created at will according to technical and aesthetic requirements. Recommended for edging and/or joining floating floors in wood & melamine-laminated wood. It is made in anodized aluminium and in 10 wood effect finishes; it comes in various heights, length 2.7m.

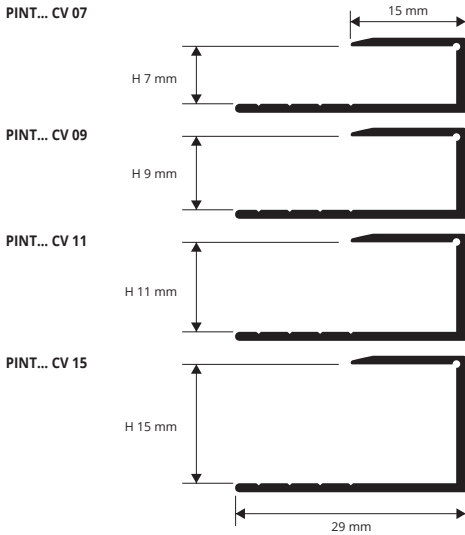

**ANODIZED SILVER ALUMINIUM CURVABLE thermo packed**  
bar length 2,7 lm - pack. 20 Pcs - 54 lm

Article	H mm
PINTAACV 07	7
PINTAACV 09	9
PINTAACV 11	11
PINTAACV 15	15



**ALUMINIUM 10 WOOD FINISHES thermo packed**  
bar length 2,7 lm - pack. 20 Pcs - 54 lm

Article	H mm
PINT... CV 09	9
PINT... CV 15	15

Available in the wood finishes: 04W-05W-07W-08W-09W-10W-11W-28W-29W-30W.  
The code of the selected colour must be added to the article code.  
E.g.: PINT... CV 09 (chosen finish Dark beech) PINT04W CV 09.

## EXAMPLES AND INSTRUCTIONS FOR LAYING METHODS

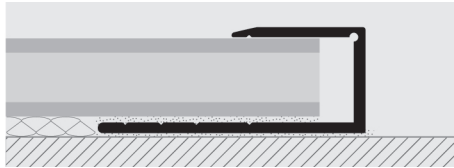

1. Choose the "TERMINAL CURVE" in the required height and material. 2. Cut the profile to the necessary length, calculating the total length. 3. Bend the profile mechanically with the PROCURVE MACHINE. 4. If necessary fix with screws and screw anchors or simply insert the punched base under the floor laid with the same adhesive.

## COLOURS



## ON DEMAND MINIMUM QUANTITY 100 PCS

--

# PROCOVER PROCOVER WOOD

ANODIZED ALUMINIUM AND WOOD FINISHES - CURVABLE

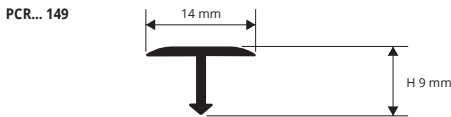
**PROCOVER** is a joint-cover profile in anodized aluminium and aluminium covered with a very strong film available in wood finishes. It is applied at the end of laying two adjoining floors with the same height, having left a 6 - 24 mm gap between the two floors set in a thin bed of adhesive. It protects the outside edges of the floor/covering. It is easy to lay and attractive. The design of the profile with lower vertical arrowhead part allows excellent anchorage with the silicone/adhesive.



## EXAMPLES AND INSTRUCTIONS FOR LAYING METHODS

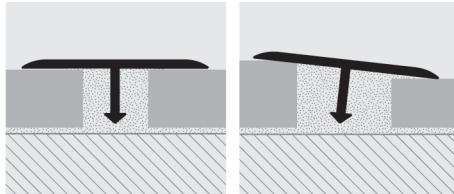

1. Choose the "PROCOVER" with the width suitable for the gap between the two floors to be joined, taking into consideration 2/3 mm side lap. 2. Fill the gap with single-pack silicone or with the adhesive used for laying the floor. 3. Bury the profile into the adhesive, making sure that both side laps of the profile rest on the coverings to be joined.



**ANODIZED SILVER ALUMINIUM CURVABLE thermo packed**  
bar length 2,7 lm - pack. 40 Pcs - 108 lm

Article	H mm
PCRAA 149	14 x 9
PCRDB 149	14 x 9



**ALUMINIUM WOOD FINISHES thermo packed**  
bar length 2,7 lm - pack. 40 Pcs - 108 lm

Article	L x H mm
PCRA... 149	14 x 9

Available in the wood finishes: 05W-11W-28W-29W-30W.  
The code of the selected colour must be added to the article code.  
E.g.: PCRA... 149 (chosen finish Dark beech) PCRA 04W 149.

## COLOURS

\* = Production on demand with minimum quantity of 100 pcs. Production delay 4/5 weeks. Price to be agreed

**PROSLIDER CURVE** is a range of transition profiles that may be curved/shaped, with a special system of perforations allowing it to be bent so that particular geometric shapes may be easily obtained in situ. This allows decorative patterns to be created at will according to technical and aesthetic requirements. Recommended for joining floating floors in wood, melamine laminated wood and ceramics. It is made in natural brass in various heights, length 2.7 lm.

# PROSLIDER CURVE

NATURAL BRASS CURVABLE

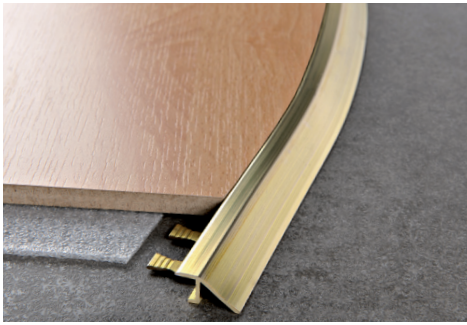

**NATURAL BRASS CURVABLE thermo packed**  
bar length 2,7 lm - pack. 15 Pcs - 40,5 lm

Article	H mm		
PDONCV 08	8		
PDONCV 10	10		

#### COLOURS



#### LAYING INSTRUCTIONS

1. Choose the "PROSLIDER CURVE" in the required height and material.
2. Cut the profile to the necessary length, calculating the total length.
3. Bend the profile mechanically with the PROCURVE MACHINE.
4. If necessary fix with screws and screw anchors, if used for floating floors in melamine/laminated wood, or simply insert the punched base under the floor laid with the same adhesive.

PDONCV 08



PDONCV 10



#### EXAMPLES OF LAYING

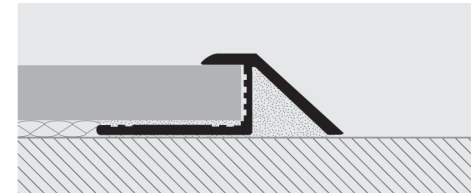

**PROSLIDER CURVE** is a range of transition profiles that may be curved/shaped, with a special system of perforations allowing it to be bent so that particular geometric shapes may be easily obtained in situ. This allows decorative patterns to be created at will according to technical and aesthetic requirements. Recommended for joining floating floors in wood, melamine laminated wood and ceramics. It is made in anodized aluminium in various heights, length 2.7 lm.

# PROSLIDER CURVE

ANODIZED SILVER ALUMINIUM CURVABLE



**ANODIZED SILVER ALUMINIUM CURVABLE thermo packed**  
bar length 2,7 lm - pack. 20 Pcs - 54 lm

Article	H mm		
PDAACV 08	8		
PDAACV 10	10		

#### COLOURS

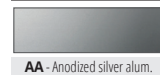

PDAACV 08



PDAACV 10



**PROCURVE MACHINE** is a manual profile bending machine for profiles of the CURVE SERIES. complete with wheels for all profiles

# PROCURVE MACHINE

Article	
PCM 08	PROCURVE MACHINE



Page	Items / series available for	MINIMUM INSIDE RADIUS	MINIMUM OUTSIDE RADIUS
100	PTACCV	30 cm	30 cm
101	PTONCV	30 cm	30 cm
101	PTANCV	30 cm	30 cm
103	PELONCV	150 cm	300 cm
103	PELAACV	200 cm	300 cm
104	PRFONCV	200 cm	
104	PRFAACV	200 cm	
105	PJONCV	200 cm	300 cm
105	PJAACV	200 cm	300 cm
106	PINTAACV	300 cm	
106	PCRAA 149	80 cm	80 cm
106	PCRA... 149	100 cm	100 cm
107	PDONCV	300 cm	
107	PDAACV	300 cm	

\* = Production on demand with minimum quantity of 100 pcs. Production delay 4/5 weeks. Price to be agreed



An interpretation of:  
**Elbphilharmonie, Herzog & De Meuron, HAMBURG (Germany), 2017**

STAIR NOSINGS PROFILES

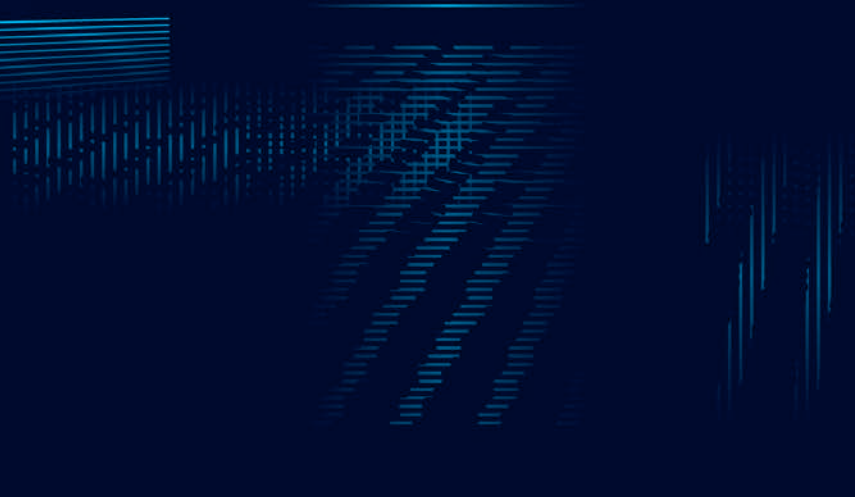
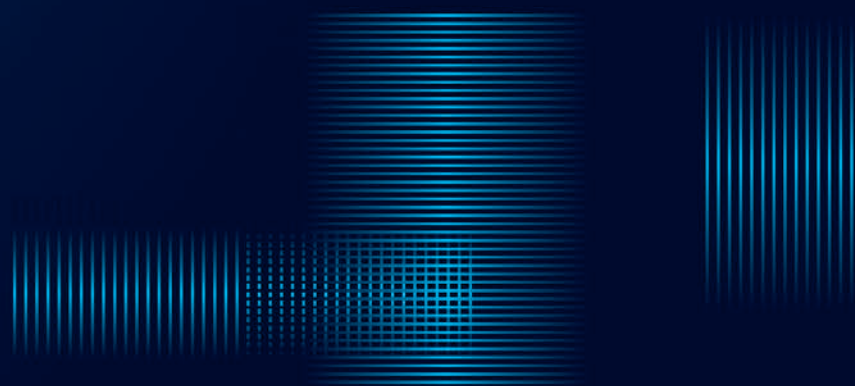
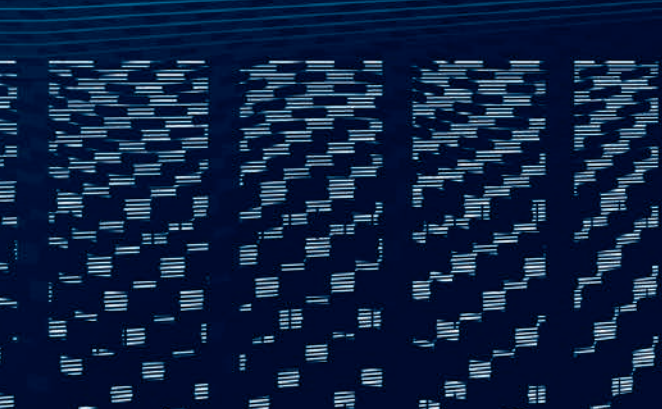
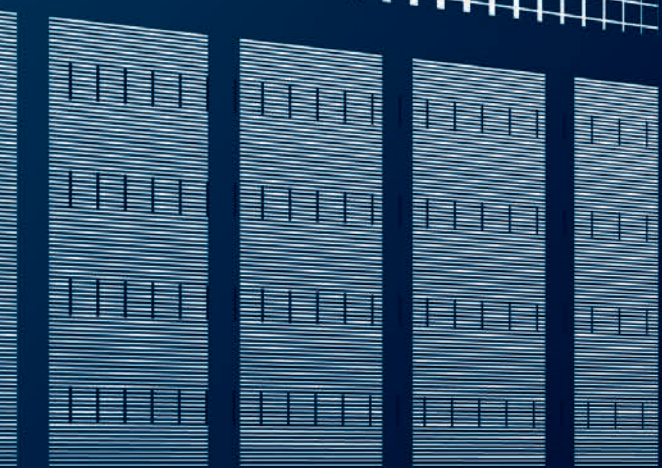
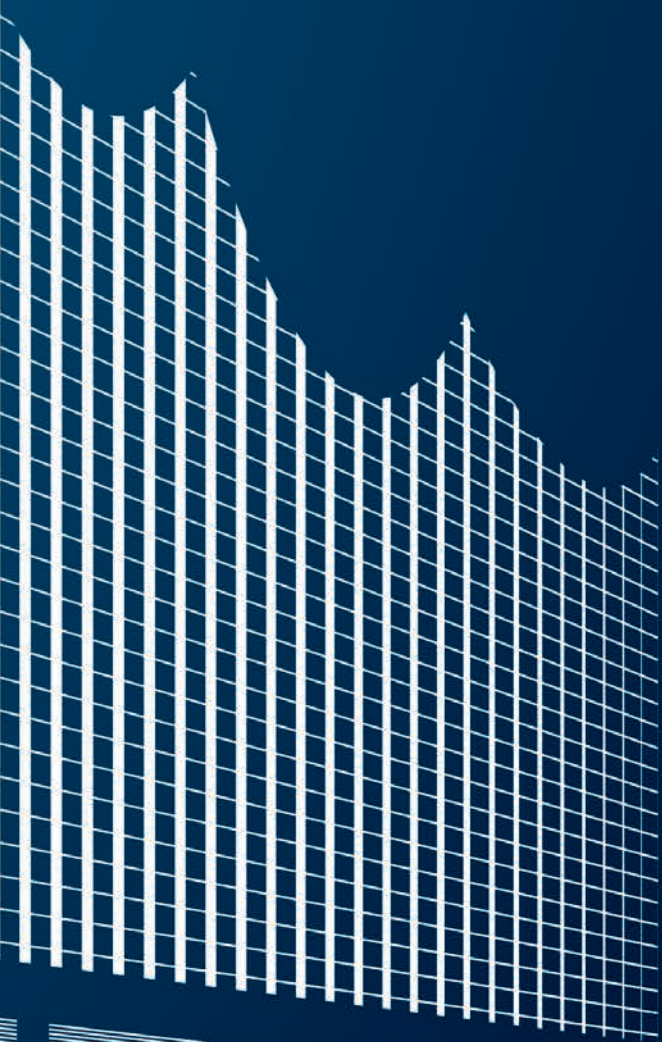

# PROSTAR ACC

BRUSHED STAINLESS STEEL AISI 304/1.4301-V2A

**PROSTAR ACC** is steps protecting technical profile, designed and conceived to make the step scales made of ceramic, porcelain stoneware and others nonskid and non-slip ones ; it's to be applied before the step laying process. Manufactured in aisi 304/1.4301-V2A glazed stainless steel, with the superior side level crimped in order to increase its adhesion. It replaces special ceramic elements in refined, resistant and economic way. It is compulsory in public places for the accident prevention. It is recommended for elegant, refined industrial, commercial and private environments: available in H 4,5-6-8-10-12,5-15 mm versions. Combining with the entire series of steel profiles recommended.

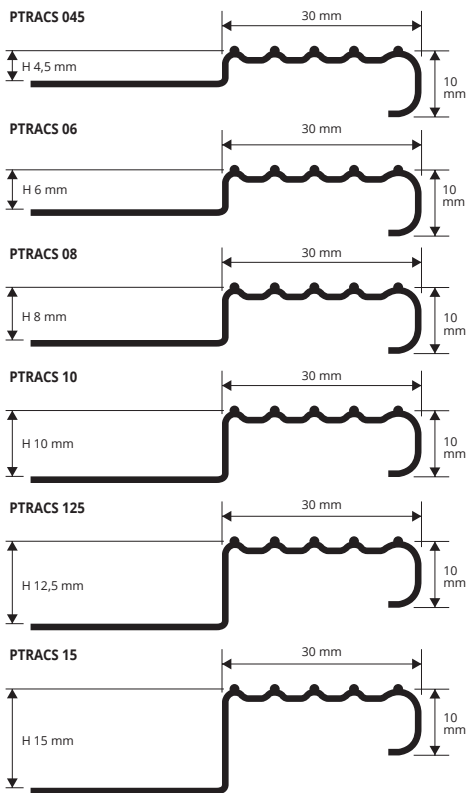

### EXAMPLES OF LAYING

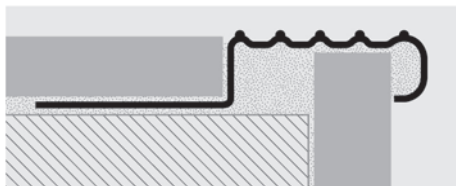

BRUSHED STAINLESS ST. AISI 304/1.4301-V2A with protective film  
bar length 2,7 lm - pack. 15 Pcs - 40,5 lm - 10/10 mm

Article	H mm
PTRACS 045	4,5
PTRACS 06	6
PTRACS 08	8
PTRACS 10	10
PTRACS 125	12,5
PTRACS 15	15

Available in Brushed STAINLESS STEEL AISI 316L/1.440-V4A (minimum quantity order 100 pcs - price to be agreed. Production delay 4/5 weeks).

### LAYING INSTRUCTIONS

1. Choose the PROSTAR ACC of the desired height and material on the basis of the tile (steps) thickness.
2. Fix the first rising part laying it down at its appropriate and definitive level.
3. Fill completely the empty spaces under the profile with the tile adhesive.
4. Spread out the adhesive on the tread, lay down the profile with its cut base immersed completely in adhesive and align it so that the profile covers the riser tile edge.
5. Lay down the tread tiles and align them with the superior grazing part of the profile by drawing its back close and filling the inner space with the adhesive.

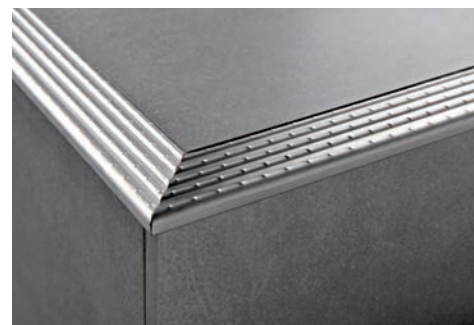

END CAP IN VARNISHED PLASTIC BRUSHED STAINLESS STEEL EFFECT  
pack. 2 Pcs (1 right and 1 left)

Article	H mm
TPTRACS/1	4,5 ÷ 15

Articles not for sale singly

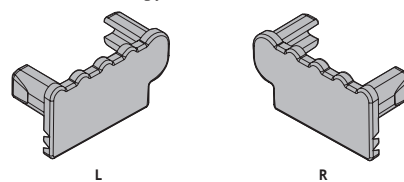

### COLOURS



SUITABLE FOR USE IN CONTACT WITH FOODSTUFFS

# PROSTYLE 2610

BRUSHED STAINLESS STEEL AISI 304/1.4301-V2A  
SELF ADHESIVE OR PUNCHED

**PROSTYLE 2610** is steps protecting technical profile, designed and conceived to keep the step scales made of ceramic, porcelain stoneware, wood, marble and others nonskid and non-slip ones ; it's to be applied after the step laying process or in the already present rooms. Manufactured in aisi 304/1.4301-V2A glazed stainless steel, with the superior side level crimped in order to increase its adhesion. It replaces special ceramic elements in refined, resistant and economic way. It's ideal for the edges protection and screening as well as of the corner between the rising and the tread which is the point of the greatest strain. It is compulsory in public places for the accident prevention. It is recommended for elegant, refined industrial, commercial and private environments. Available in drilled version or in with adhesive one.

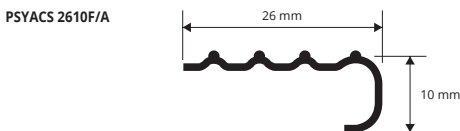

### EXAMPLES AND INSTRUCTIONS FOR LAYING METHODS

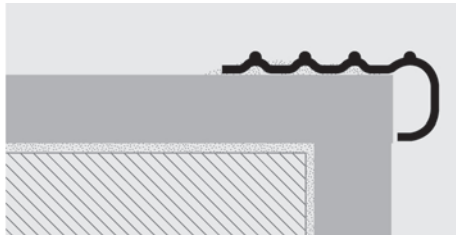

#### Adhesive version

1. Choose the suitable profile and cut it to the necessary length.
2. Degrease, wash and clean the solid surface thoroughly.
3. Remove the protective paper from the adhesive.
4. Lay the profile by applying pressure evenly over the whole surface without using a hammer.

#### Punched version

1. Choose the suitable profile and cut it to the necessary length.
2. Mark the position of the holes using the existing holes in the profile as reference.
3. Insert the screw anchors into the drilled holes.
4. Fix the profile using flathead screws suitable for the relative slots in the profile.

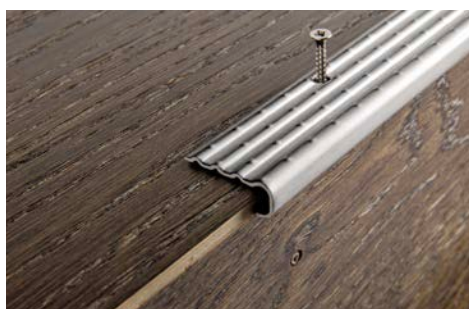

BRUSHED STAINLESS STEEL AISI 304/1.4301-V2A PUNCHED with  
protective film - bar length 2,7 lm - pack. 20 Pcs - 54 lm - 10/10mm

Article	H mm
PSYACS 2610F	10

Available in Brushed STAINLESS STEEL AISI 316L/1.440-V4A (minimum quantity order 100 pcs - price to be agreed. Production delay 4/5 weeks).



BRUSHED STAINLESS STEEL AISI 304/1.4301-V2A WITH ADHESIVE with  
protective film - bar length 2,7 lm - pack. 20 Pcs - 54 lm - 10/10mm

Article	H mm
PSYACS 2610A	10

### COLOURS

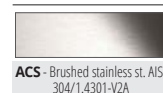

SUITABLE FOR USE IN CONTACT WITH FOODSTUFFS

\* = Production on demand with minimum quantity of 100 pcs. Production delay 4/5 weeks. Price to be agreed

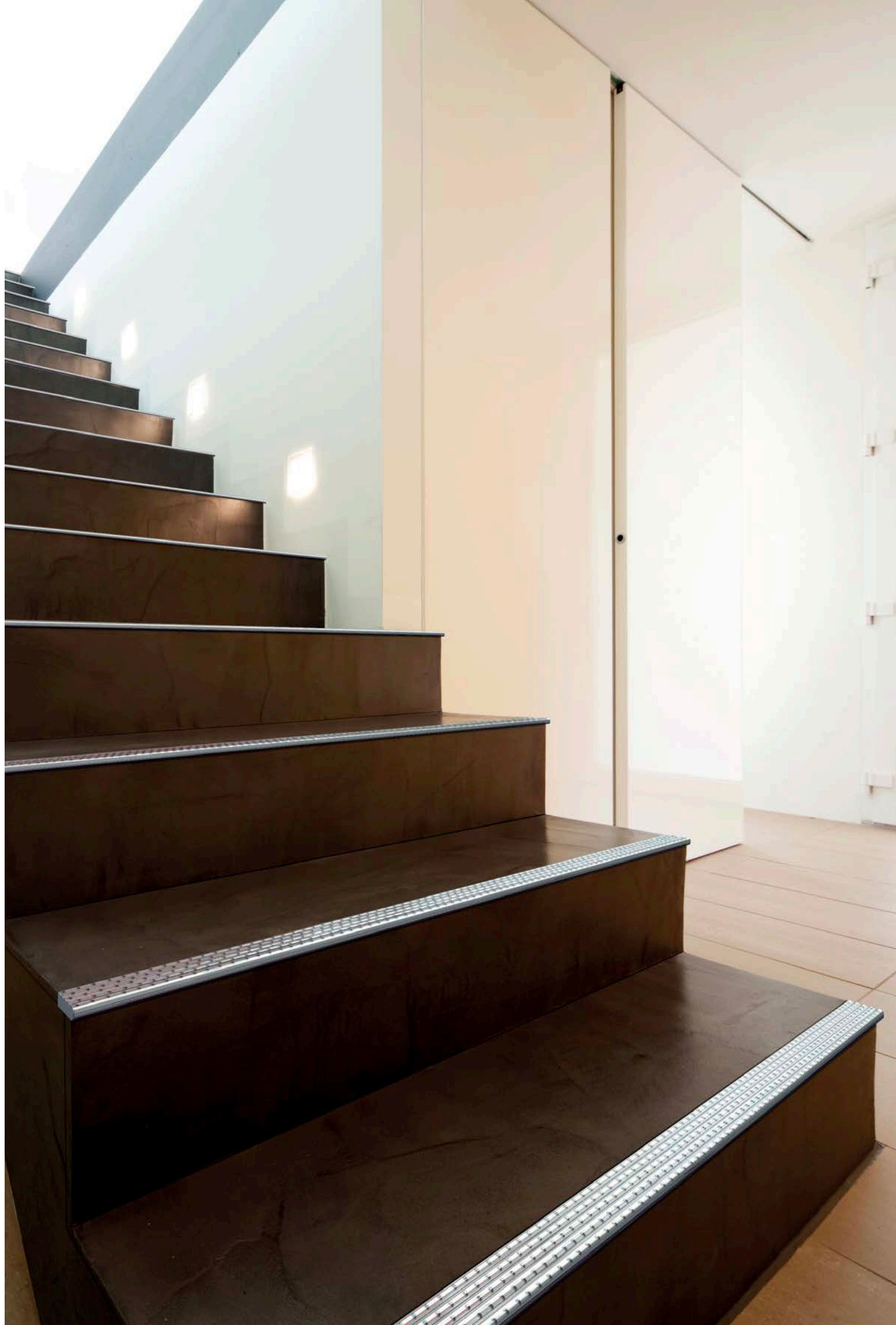





**PROSTAIR GRIP ACC** is an AISI 304/1.4301-V2A brushed stainless steel profile, consisting of a punched flange, ensuring perfect anchorage to the substrate, a 36,5 and 56,5mm horizontal visually exposed surface with the carborundum stripe insert and a 20mm vertical visually exposed flat surface. The profile is available in the heights 4,5/6/8/10/12,5/15/20 mm and is equipped with end caps made of varnished plastic in brushed steel-effect finish. The design of this profile together with the completing elements make it an elegant and appreciated solution also for modern stairs.

# PROSTAIR GRIP ACC

BRUSHED STAINLESS STEEL AISI 304/1.4301-V2A

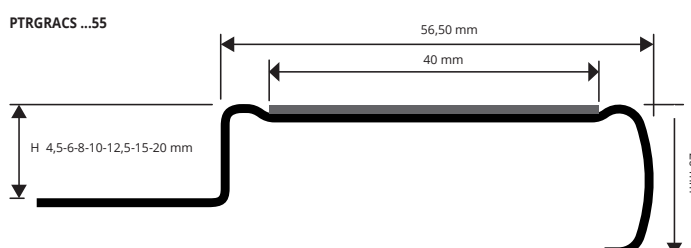
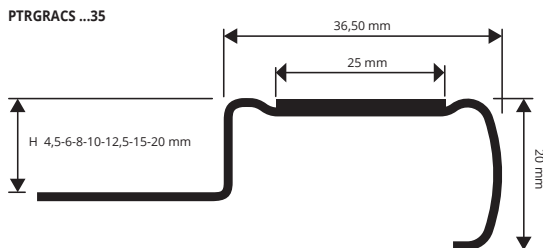

**BRUSHED STAINLESS STEEL AISI 304/1.4301-V2A**  
with protective film - bar length 2,7 lm - width 36,50 mm

Article	H mm	Pcs/Pack
PTRGRACS 04535	4,5	20
PTRGRACS 0635	6	20
PTRGRACS 0835	8	20
PTRGRACS 1035	10	10
PTRGRACS 12535	12,5	10
PTRGRACS 1535	15	7
PTRGRACS 2035	20	7

**BRUSHED STAINLESS STEEL AISI 304/1.4301-V2A**  
with protective film - bar length 2,7 lm - width 56,50 mm

Article	H mm	Pcs/Pack
PTRGRACS 04555	4,5	20
PTRGRACS 0655	6	20
PTRGRACS 0855	8	20
PTRGRACS 1055	10	10
PTRGRACS 12555	12,5	10
PTRGRACS 1555	15	7
PTRGRACS 2055	20	7

THE ADHESIVE CARBORUNDUM STRIP (PROGRIP) IS NOT INCLUDED WITH THE PROFILE.

FOR PTRGRACS ...35 ORDER PGR... 25 (SPECIFY THE CHOSEN COLOUR).

FOR PTRGRACS ...55 ORDER PGR... 40 (SPECIFY THE CHOSEN COLOUR).

### COLOURS



ACS - Brushed stainless st. AISI 304/1.4301-V2A

### END CAPS - R/L - pack. 2 Pcs (1 R and 1 L)

Article	H mm	L mm
TPTRGRACS 55/1	4,5+20	56,5
TPTRGRACS 35/1	4,5+20	36,5

Articles not for sale singly

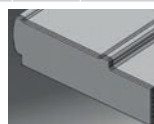

SUITABLE FOR USE IN CONTACT WITH FOODSTUFFS

### EXAMPLES AND INSTRUCTIONS FOR LAYING METHODS

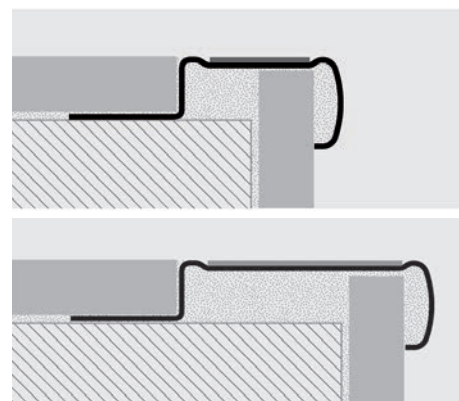

1. Choose the PROSTAIR GRIP ACC in the required height, according to the thickness of the floor covering and the desired profile width;
2. Lay the floor covering on the stair riser and apply the adhesive on the of stair tread, where the profile will be installed;
3. Fill the empty spaces under the profile with the adhesive for tiles. Lay the profile on the step tread, making sure that it is aligned with the stair riser;
4. Lay the floor covering on the stair tread and align;
5. Plaster the joints between the profile and the tiles.

**PROGRIP** is a carborundum adhesive stripe, consisting of an elastic film coated with high wear resistant abrasive grains. It is usually employed in public as well as in domestic environments to make stair steps non-slip. The stripe is available in different colors and widths to meet any technical and aesthetic requirement. If **PROGRIP** is applied directly on the step covering, it is advisable to apply two stripes on each step, rounding their ends.

# PROGRIP

ADHESIVE CARBORUNDUM - 7 COLOURS

### COLOURS

Article	Width mm	
N - Black	B - White	T - Transparent
G - Gray	Y - Yellow	M - Brown
GN - Yellow/Black	The PGR (transparent) are not suitable for outside use.	

ADHESIVE NON-SLIP STRIP for STEPS - rolls length 18,2 lm

Article	Width mm
PGRGN 20	20
PGRGN 25	25
PGRGN 50	50

ADHESIVE NON-SLIP STRIP for STEPS - rolls length 18,2 lm

Article	Width mm
PGRN 25	25
PGRB 25	25
PGRT 25	25
PGRG 25	25
PGRY 25	25
PGRM 25	25
PGRN 40	40
PGRB 40	40
PGRT 40	40
PGRG 40	40
PGRY 40	40
PGRM 40	40



\* = Production on demand with minimum quantity of 10 rolls. Production delay 4/5 weeks. Price to be agreed

News 2021

# PROSTYLE GRIP ACC

BRUSHED STAINLESS STEEL  
AISI 304/1.4301-V2A

**PROSTYLE GRIP ACC** is a non-slip profile in AISI 304/1.4301-V2A brushed stainless steel, consisting of a 40 or 60 mm horizontal top with a groove for the insertion of a non-slip carborundum stripe and a 20mm vertical flat side. The profile can be fixed with adhesive film or with screws. The particular design of this profile makes it an elegant and appreciated solution also for modern stairs.

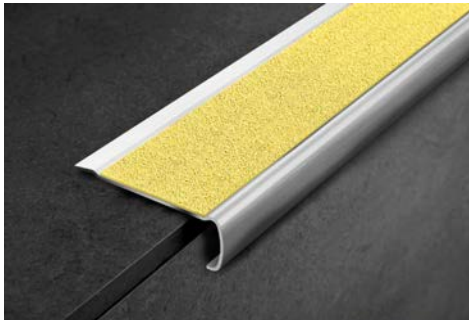

PSYGRACS 6020

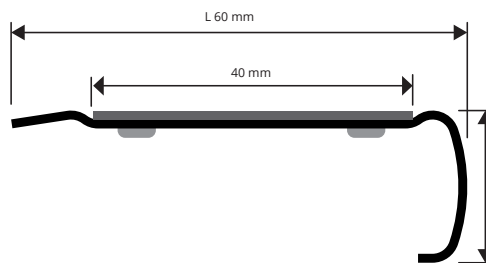

PSYGRACS 4020

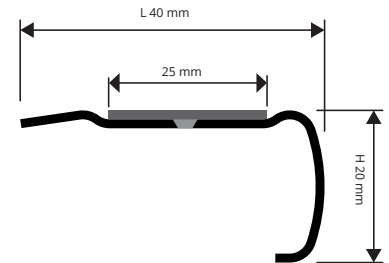

BRUSHED STAINLESS STEEL AISI 304/1.4301-V2A with protective film  
bar length 2,7 lm - pack. 20 Pcs - 54 lm

Article	L mm		
PSYGRACS 6020A	60		*
PSYGRACS 6020F	60		*

BRUSHED STAINLESS STEEL AISI 304/1.4301-V2A with protective film  
bar length 2,7 lm - pack. 20 Pcs - 54 lm

Article	L mm		
PSYGRACS 4020A	40		
PSYGRACS 4020F	40		

The adhesive carborundum strip (PROGRIP) is not included with the profile.  
For PSYGRACS 6020A/F order PGR... 40 (Specify the chosen colour).  
For PSYGRACS 4020A/F order PGR... 25 (Specify the chosen colour).

## COLOURS



## END CAPS STAINLESS STEEL - R/L - pack. 2 Pcs - (1 R and 1 L)

Article	L mm		
TPSYGRACS 6020/1	60		
TPSYGRACS 4020/1	40		

Articles not for sale singly

## SUITABLE FOR USE IN CONTACT WITH FOODSTUFFS

\* = Production on demand with minimum quantity of 100 pcs. Production delay 4/5 weeks. Price to be agreed

# PROGRIP

ADHESIVE CARBORUNDUM - 7 COLOURS

**PROGRIP** is a carborundum adhesive stripe, consisting of an elastic film coated with high wear resistant abrasive grains. It is usually employed in public as well as in domestic environments to make stair steps non-slip. The stripe is available in different colors and widths to meet any technical and aesthetic requirement. If **PROGRIP** is applied directly on the step covering, it is advisable to apply two stripes on each step, rounding their ends.



## ADHESIVE CARBORUNDUM NON-SLIP STRIP for STEPS

rolls length 18,2 lm

Article	Width mm		
PGRN 25	25		
PGRB 25	25		
PGRT 25	25		
PGRG 25	25		
PGRY 25	25		
PGRM 25	25		
PGRN 40	40		
PGRB 40	40		
PGRT 40	40		
PGRG 40	40		
PGRY 40	40		
PGRM 40	40		

## COLOURS

N - Black	B - White	T - Transparent
G - Gray	Y - Yellow	M - Brown
GN - Yellow/Black	The PGRT (transparent) are not suitable for outside use.	

## ADHESIVE NON-SLIP STRIP for STEPS - rolls length 18,2 lm

Article	Width mm		
PGRGN 20	20		
PGRGN 25	25		
PGRGN 50	50		

\* = Production on demand with minimum quantity of 10 rolls. Production delay 4/5 weeks. Price to be agreed

News 2021



**PROSTAIR 50** is a technical square used to make the step nonskid and non-slip, protects the ceramic stairs steps preventing from accidents. It is made up of a rigid aluminium base equipped with a particular tooting on the vertical stem which strengthens the anchorage of the adhesive/tile to the square. The aluminium base varies according to the thickness of the tile used in the step, and to a lined insert in vinyl rubber available in several colors. The insert is already applied to the aluminium base. It is compulsory in public places in compliance with EEC norms and prevents from accidents.

# PROSTAIR 50

NATURAL ALUMINIUM  
+ VINYL RESIN / RUBBER INSERT



NATURAL ALUMINIUM + VINYL RESIN / RUBBER INSERT  
bar length 2,7 lm - pack. 20 Pcs - 54 lm

Article	H mm
PTR50 08...	8
PTR50 10...	10
PTR50 125...	12,5
PTR50 15...	15

Available in the colours: G - N - B - A.  
The code of the selected colour must be added to the article code.  
E.g.: PTR50 08... (chosen colour grey) PTR50 08G.

## COLOURS

G - Gray (E83)	N - Black (E85)	B - Beige (E84)
A - Ivory (E81)		

END CAP IN PVC - pack. 2 Pcs (1 R and 1 L)

Article	H mm
TPTR50 .../1	8-10-12,5-15

Available in the colours: G - N - B - A.  
The code of the selected colour must be added to the article code.  
E.g.: TPTR50 ... (chosen colour grey) TPTR50 G.

Articles not for sale singly

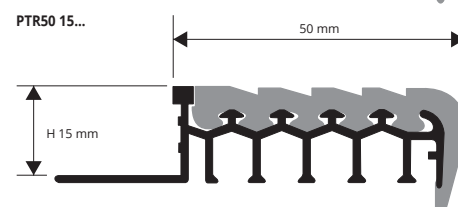
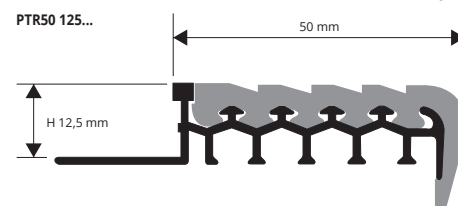
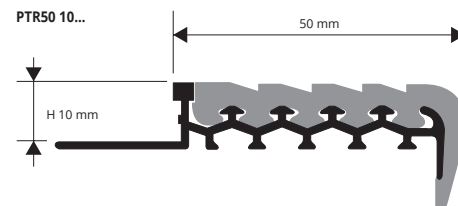
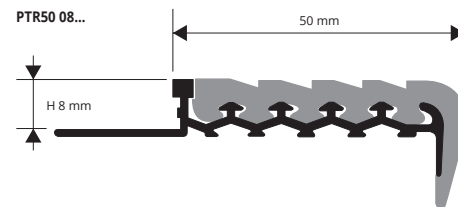
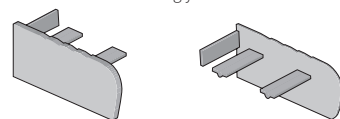

## EXAMPLES AND INSTRUCTIONS FOR LAYING METHODS

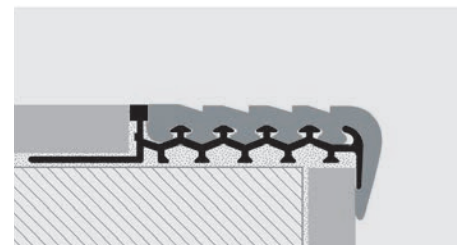

1. Choose a PROSTAIR 50 height and color corresponding to the thickness of the tile. 2. Fix the riser laying it at the appropriate and definitive height. 3. Fill the empty spaces under the square completely with adhesive. 4. Rest the adhesive on the tread, lay the square with the base cut in the adhesive and line it up so that the square covers the tile edge of the riser. 5. Lay the tiles of the tread lining them up with upper part of the square so that it meets with the edge.

# INTERCHANGEABLE INSERT for Prostairs 50

VINYL RESIN / RUBBER

INTERCHANGEABLE VINYL RESIN / RUBBER INSERT

bar length 2,7 lm - pack. 20 Pcs - 54 lm

Article	H mm
PTG50...	8-10-12,5-15

Universal insert suitable for four profile heights.  
Available in the colours: G - N - B - A.  
The code of the selected colour must be added to the article code.  
E.g.: PTG50... (chosen colour grey) PTG50 G.

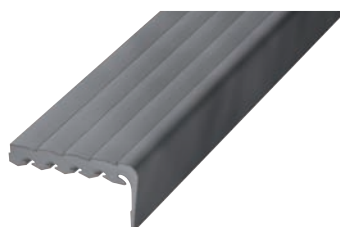

# PROSTAIR

NATURAL ALUMINIUM  
+ VINYL RESIN / RUBBER INSERT

**PROSTAIR** is a step nosing profile used to improve slip and slide resistance on the step, to protect ceramic steps and to prevent accidents. It consists of a rigid aluminium base and a changeable vinyl rubber insert available in various colours and widths. Compulsory in public environments to comply with EEC accident-prevention standards.

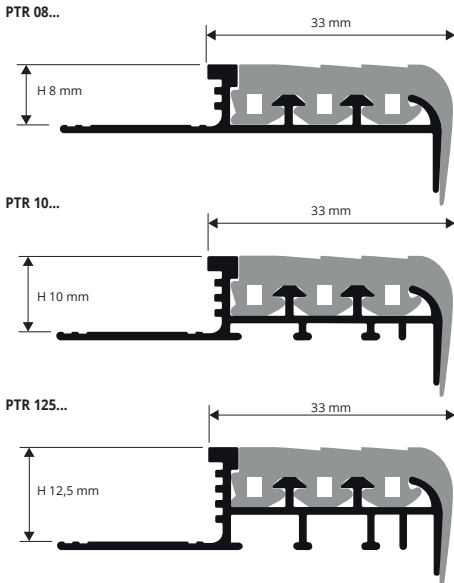

### EXAMPLES AND INSTRUCTIONS FOR LAYING METHODS

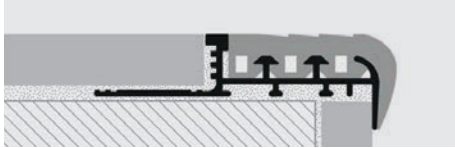

1. Choose the PROSTEP/PROSTAIR in the required width and colour according to the thickness of the tile. 2. First fix the riser part, placing it at the correct and final height. 3. Fill the empty spaces under the profile with the tile adhesive. 4. Apply the adhesive to the tread, lay the profile with the punched base fully sunk into the adhesive and align the profile so that its lip covers the edge of the riser tile. 5. Lay the tread tiles, aligning them so that they are flush with the upper and rear part of the profile.



### INTERCHANGEABLE VINYL RESIN / RUBBER INSERT

bar length 2,7 lm - pack. 20 Pcs - 54 lm

Article		
PTGRA		
PTGRB		
PTGRN		
PTGRG		



### COLOURS

G - Gray (E83)	N - Black (E85)	B - Beige (E84)
A - Ivory (E81)		

### NATURAL ALUMINIUM + VINYL RESIN / RUBBER INSERT

bar length 2,7 lm - pack. 10 Pcs - 27 lm

Article	H mm	
PTR 08...	8	
PTR 10...	10	
PTR 125...	12,5	

Available in the colours: G - N - B - A. The code of the selected colour must be added to the article code. E.g.: PTR 08... (chosen colour grey) PTR 08G.

### END CAP IN PVC - pack. 2 Pcs (1 R and 1 L)

Article	H mm	
TPT 08.../1	8	
TPT 10.../1	10	
TPT 125.../1	12,5	

Available in the colours: G - N - B - A. The code of the selected colour must be added to the article code. E.g.: TPT 08... (chosen colour grey) TPT 08G. Articles not for sale singly

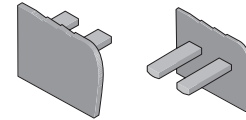

# PROSTEP

RIGID VINYL RESIN  
+ VINYL RESIN / RUBBER INSERT

**PROSTEP** is a step nosing profile used to improve slip and slide resistance on the step, to protect ceramic steps and to prevent accidents. It consists of a rigid base in high-strength vinyl resin and a changeable vinyl rubber insert available in various colours and widths. Compulsory in public environments to comply with EEC accident-prevention standards.

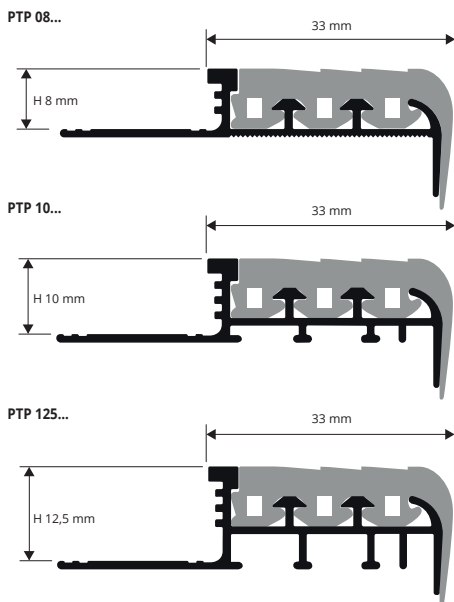

For instructions see the product above



### INTERCHANGEABLE VINYL RESIN / RUBBER INSERT

bar length 2,7 lm - pack. 20 Pcs - 54 lm

Article		
PTGRA		
PTGRB		
PTGRN		
PTGRG		

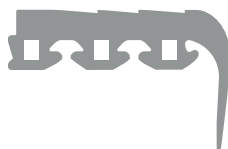

### COLOURS

G - Gray (E83)	N - Black (E85)	B - Beige (E84)	A - Ivory (E81)

### IMPACT PROOF VINYL RESIN + VINYL RESIN / RUBBER INSERT

bar length 2,7 lm - pack. 10 Pcs - 27 lm (PTP 08... - 54 lm)

Article	H mm	
PTP 08...	8	
PTP 10...	10	
PTP 125...	12,5	

Available in the colours: G - N - B - A. The code of the selected colour must be added to the article code. E.g.: PTP 08... (chosen colour grey) PTP 08G.

### END CAP IN PVC - pack. 2 Pcs (1 R and 1 L)

Article	H mm	
TPT 08.../1	8	
TPT 10.../1	10	
TPT 125.../1	12,5	

Available in the colours: G - N - B - A. The code of the selected colour must be added to the article code. E.g.: TPT 08... (chosen colour grey) TPT 08G. Articles not for sale singly

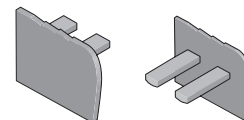



**PROBRASSTEP** is a very elegant step nosing profile used to improve slip and slide resistance on the step. Made in natural and polished brass or natural and anodized silver aluminium, the upper part is knurled to increase adherence. Compulsory in public buildings to comply with accident-prevention regulations. Recommended for elegant, refined surroundings and for steps in wood, tiles, melamine-coated/laminated wood, marble or natural stones. Width: 8, 10, 12.5 mm.

# PROBRASSTEP

KNURLED NATURAL AND POLISHED BRASS  
NATURAL AND ANODIZED SILVER ALUMINIUM

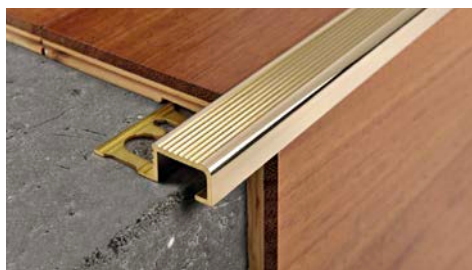

**NATURAL BRASS thermo packed 5 Pcs**  
bar length 2,7 lm - pack. 20 Pcs - 54 lm

Article	H mm		
PBPON 10	10		*
PBPON 125	12,5		

**POLISHED BRASS thermo packed**  
bar length 2,7 lm - pack. 20 Pcs - 54 lm

Article	H mm		
PBPOL 10	10		*
PBPOL 125	12,5		*

**NATURAL ALUMINIUM thermo packed 5 Pcs**  
bar length 2,7 lm - pack. 20 Pcs - 54 lm

Article	H mm		
PBPAN 08	8		
PBPAN 10	10		
PBPAN 125	12,5		

**ANODIZED SILVER ALUMINIUM thermo packed**  
bar length 2,7 lm - pack. 20 Pcs - 54 lm

Article	H mm		
PBPAA 08	8		
PBPAA 10	10		
PBPAA 125	12,5		

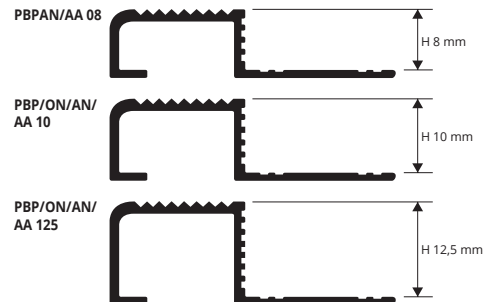

### EXAMPLES AND INSTRUCTIONS FOR LAYING METHODS

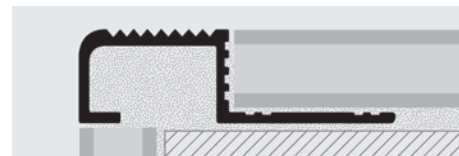

1. Choose the PROBRASSTEP in the required width and colour according to the thickness of the tile (stairs).
  2. First fix the riser part, placing it at the correct and final height.
  3. Fill the empty spaces under the tread, lay the profile with the punched base fully sunk into the adhesive and align the profile so that its lip covers the edge of the riser tile.
  4. Apply the adhesive to the tread, lay the profile with the punched base fully sunk into the adhesive and align the profile so that its lip covers the edge of the riser tile.
  5. Lay the tread tiles, aligning them so that they are flush with the upper and rear part of the profile and filling the internal part with adhesive.
- Oxidation marks in the polished/natural brass range may be easily removed with specific chemical products (Sidol-Smac).

### COLOURS



**PROSTAIR BOTTON / STRIP** are a tactile anti-slip botton/strip made in stainless steel AISI 316/1.4401-V4A. **PROSTAIR BOTTON / STRIP** has the function to realize the signaling lanes to the floor, and warning stairs, able to guide the blind and visually impaired. It is available with a length of 28.5 cm, a width of 3.5 cm and a thickness of 5mm and is provided with 3 stems, 2 cm high, for its fastening.

# PROSTAIR BOTTON / STRIP

POLISHED, BRUSHED STAINLESS STEEL AISI 316/1.4404-V4A



**PROSTAIR BOTTON**  
**POLISHED STAINLESS STEEL AISI 316/1.4404-V4A - pack. 20 Pcs**

Article	Ø mm		
PTRB 3520/20	35		

**PROSTAIR BOTTON STRIP**  
**BRUSHED STAINLESS STEEL AISI 316/1.4404-V4A - pack. 10 Pcs**

Article	L x H mm		
PTRB 28035/10	280 X 35		

### INSTRUCTIONS FOR LAYING METHODS

1. Put PROSTAIR BOTTON TEMPLATE on the desired zone.
2. Score on the support the position of the necessary holes.
3. Remove the template and drill the substrate with a tip 4 mm for a depth of approximately 2.5 cm.
4. Open the holes already made with a 8mm drill bit.
5. Remove dust residues.
6. Fill the hole with PROBAND FIX.
7. Put in the hole PROSTAIR BOTTON.

### INSTRUCTIONS FOR LAYING METHODS

1. Put PROSTAIR BOTTON STRIP on the desired zone.
2. Scoring on the support in correspondence of the stems the points at which pierce.
3. Drill the substrate with a tip 4 mm for a depth of approximately 2.5 cm.
4. Open the holes already made with a 8mm drill bit.
5. Remove dust residues.
6. Fill the hole with PROBAND FIX.
7. Put in the hole PROSTAIR BOTTON STRIP.

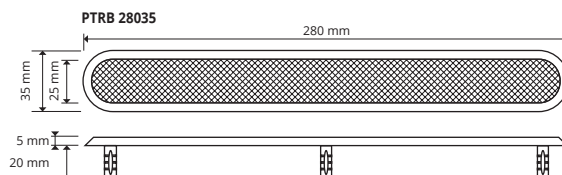
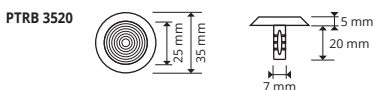

# PROSTAIR BOTTON TEMPLATE for PROSTAIR BOTTON

ZINC-PLATED STEEL

**PROSTAIR BOTTON TEMPLATE** is a mold, made in zinc-plated steel, which allows to score the points where to drilling for the mounting of PROSTAIR BOTTON. **PROSTAIR BOTTON TEMPLATE** has A Size of 30 x 44.5 cm and is Equipped with 48 holes of a diameter 4 mm. Provided with circular joints which can be connected to other molds.

**ZINC-PLATED STEEL**  
pack. 4 Pcs

Article	L x H mm		
PTRTEM/4	445 x 300		

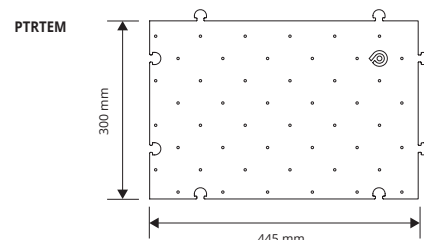

\* = Production on demand with minimum quantity of 100 pcs. Production delay 4/5 weeks. Price to be agreed

# PROTERMSTEP ACC

POLISHED, BRUSHED STAINLESS  
STEEL AISI 304/1.4301-V2A

**PROTERMSTEP ACC** is the new step cover profile made of stainless steel. Designed to protect the edge of the step and to hide the joint between the tread and the step rise. The special notched shape in the upright stem provides it with excellent anchorage between floor/glue/profile. Reversible profile.

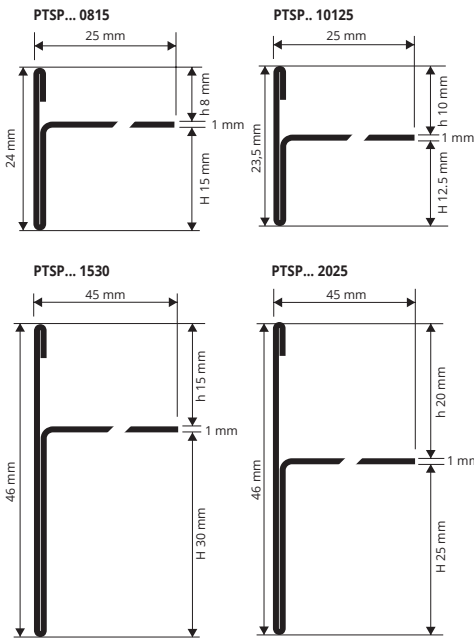

EXAMPLES OF LAYING for instructions see the product below



**POLISHED STAINLESS STEEL AISI 304/1.4301-V2A with protective film**  
bar length 2,7 lm - pack. 15 Pcs - 40,5 lm

Article	h / H mm
PTSPAC 0815	08 / 15
PTSPAC 10125	10 / 12,5
PTSPAC 1530	15 / 30
PTSPAC 2025	20 / 25

**EXTERNAL CORNERS - pack. 10 Pcs**

Article	h / H mm
REPTSAC 0815/10	08 / 15
REPTSAC 10125/10	10 / 12,5
REPTSAC 1530/10	15 / 30
REPTSAC 2025/10	20 / 25

**JUNCTION H 10 - 12,5 - 15 - 20 mm - pack. 10 Pcs**

Article	h / H mm
GIPTSAC 0815/10	08 / 15
GIPTSAC 10125/10	10 / 12,5
GIPTSAC 1530/10	15 / 30
GIPTSAC 2025/10	20 / 25



**BRUSHED STAINLESS ST. AISI 304/1.4301-V2A**  
bar length 2,7 lm - pack. 15 Pcs - 40,5 lm

Article	h / H mm
PTSPACS 0815	08 / 15
PTSPACS 10125	10 / 12,5
PTSPACS 1530	15 / 30
PTSPACS 2025	20 / 25

**COLOURS**

AC - Polished stainless st. AISI 304/1.4301-V2A	ON DEMAND	ACS - Brushed stainless st. AISI 304/1.4301-V2A

**JOINT**  
GIPTSAC ..

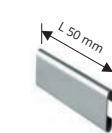

**EXTERNAL CORNER (WELDED)**  
REPTSAC ..

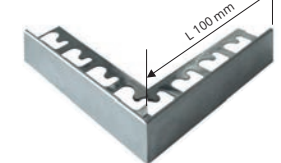

SUITABLE FOR USE IN CONTACT WITH FOODSTUFFS

# PROTERMSTEP ALL

NATURAL AND ANODIZED SILVER  
ALUMINIUM

**PROTERMSTEP ALL** is the new step cover profile made of natural and anodized aluminium. Designed to protect the edge of the step and to hide the joint between the tread and the step rise. The special notched shape in the upright stem provides it with excellent anchorage between floor/glue/profile.

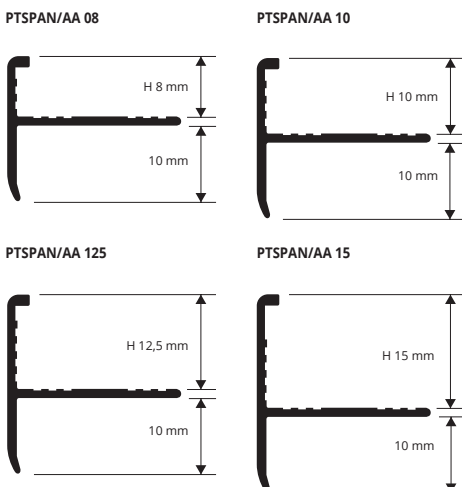

EXAMPLES AND INSTRUCTIONS FOR LAYING METHODS



**NATURAL ALUMINIUM**  
bar length 2,7 lm - pack. 20 Pcs - 54 lm

Article	H mm
PTSPAN 08	8
PTSPAN 10	10
PTSPAN 125	12,5
PTSPAN 15	15

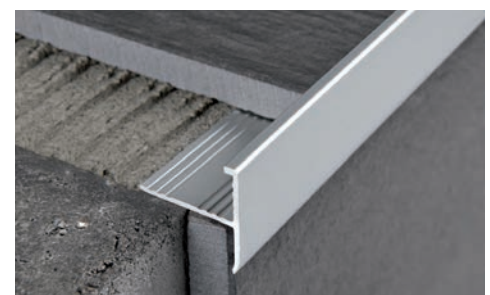

**ANODIZED SILVER ALUMINIUM thermo packed**  
bar length 2,7 lm - pack. 20 Pcs - 54 lm

Article	H mm
PTSPAA 08	8
PTSPAA 10	10
PTSPAA 125	12,5
PTSPAA 15	15

**COLOURS**

AN - Natural aluminium	AA - Anodized silver aluminium

1. Choose the PROTERMSTEP in the required width and colour according to the thickness of the tile (stairs).
2. First fix the riser part, placing it at the correct and final height.
3. Fill the empty spaces under the profile with the tile adhesive.
4. Apply the adhesive to the tread, lay the profile with the punched base fully sunk into the adhesive and align the profile so that its lip covers the edge of the riser tile.
5. Lay the tread tiles, aligning them so that they are flush with the upper and rear part of the profile and filling the internal part with adhesive.

\* = Production on demand with minimum quantity of 100 pcs. Production delay 4/5 weeks. Price to be agreed



**PROSIDE WALK** is a perimeter profile in varnished aluminium, available in grey and anthracite colour. It is designed to protect the edges of the tiles and the screed on pavements. The profile is equipped with a punched flange that ensures its fixing to the support. The flange is also provided with small holes that allow the momentary fixing of the profile with nails. To reach a right connection between profile and the waterproofing system it's needed to use **PROBAND 150** with **PROBAND KOLL/AB**. The product is also available on request in **BENDABLE VERSION** and with a **SPECIAL SEASIDE PRE-TREATMENT** which increases its resistance to corrosion when installed at sea front environments.

# PROSIDE WALK

VARNISHED / COATED ALUMINIUM



## VARNISHED EMBOSSED ALUMINIUM

bar length 2,7 lm - pack. 20 Pcs - 54 lm

Article	h mm	H mm	L
PSDWK 10AL...	10	45	80
PSDWK 125AL...	12,5	45	80
PSDWK 15AL...	15	45	80
PSDWK 20AL...	20	45	80

## EMBOSSED COLOURS

A - Anthracite grey (no RAL)	GF - Gray (7038)	TF - Dark brown (8019)

## EMBOSSED COLOURS ON DEMAND

BF - White (9010)	C - Corten	EF - Beige (1019)

## EXTERNAL CORNERS - pack. 10 Pcs

Article	h mm	H mm	L
AEPSDWK 10AL.../10	10	45	80
AEPSDWK 125AL.../10	12,5	45	80
AEPSDWK 15AL.../10	15	45	80
AEPSDWK 20AL.../10	20	45	80

## JOINTS - pack. 10 Pcs

Article
GINSDWK 10AL.../10
GINSDWK 125AL.../10
GINSDWK 15AL.../10
GINSDWK 20AL.../10

AEPSDWK external corner (welded)

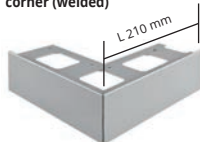

GINSDWK joint



## PSDWK 10AL / 125AL / 15AL

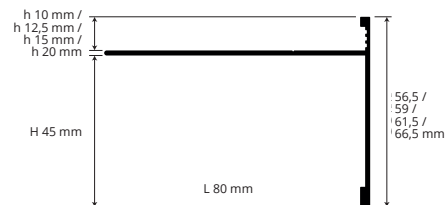

## EXAMPLES AND INSTRUCTIONS FOR LAYING METHODS



1. Choose PROSIDE WALK according to the tile thickness and desired colour.
  2. Waterproof with PROBAND 150 and PROBAND KOLL the front of the screed.
  3. Fix the external corners with nails.
  4. Cut PROSIDE WALK to the desired length and fix it with nails; connect it with the corners using the junction element.
  5. Lay the tiles, leaving about 5 mm between tiles and profile.
  6. Seal the space between tiles and profile with **PROBAND FIX (PRBFX)**.
- PROFILE BENDING: 1)** Cut the anchoring flange into sections and engrave the metal close to the vertical side **2)** bend the profile with the help of a template;

## HOW TO REQUEST SEASIDE TREATMENT

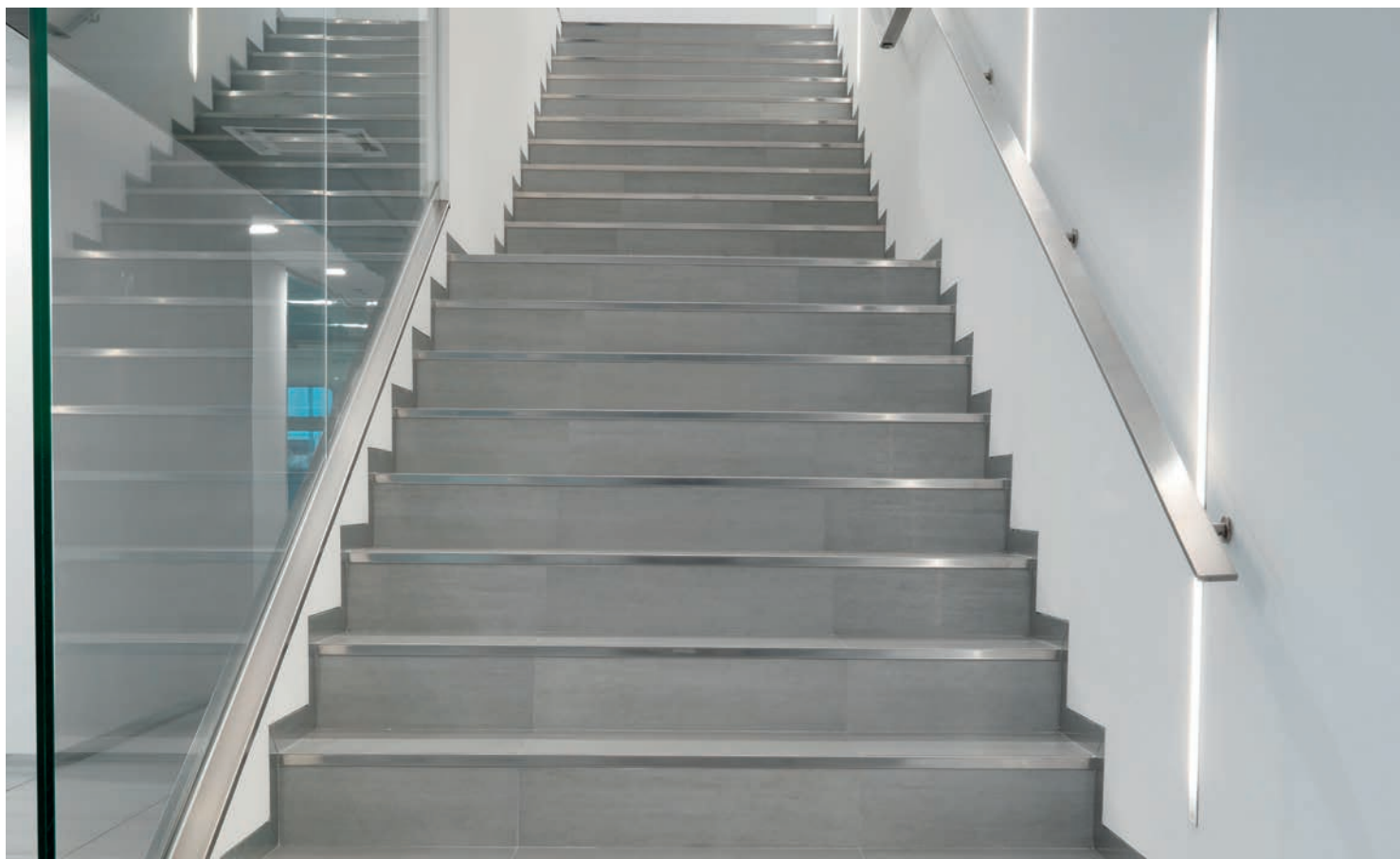

\* = Production on demand with minimum quantity of 100 pcs. Production delay 4/5 weeks. Price to be agreed

# PROSTAIR LED

ANODIZED SILVER ALUMINIUM  
- FLAT - LED

**PROSTAIR LED** is an aluminium profile available in the silver anodized finishes, that can be fixed with adhesive or dowels to the step tread. It has a grooved non-slip 52,5mm wide horizontal surface and an integrated LED lighting system, placed on its 43,5mm high vertical side. The integrated LED system generates cold or warm light and is protected by a matt or transparent polycarbonate plate, provided with a special fixing system, that allows it to be removed any time maintenance on the lighting system should be required. Its design and to the range of finishes available, together with its easy installation make **PROSTAIR LED** an appreciated solution both in public and in residential spaces.

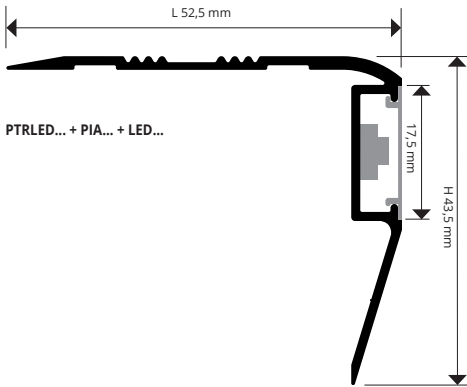

## EXAMPLES AND INSTRUCTIONS FOR LAYING METHODS



1. Choose PROSTAIR LED depending on the desired finish, light effect and polycarbonate plate; 2. If you are using the version with adhesive, clean first the surface where the profile will be installed. Once the surface has dried, remove the protective film and install the profile, applying adequate pressure on it; 3. If you are using the punched version, place the profile on the step tread and mark the position of the profile holes on the step tread; 4. Drill the step tread and fasten the profile using plugs; 5. Connect the LED to the low tension power supply and install the polycarbonate plate.

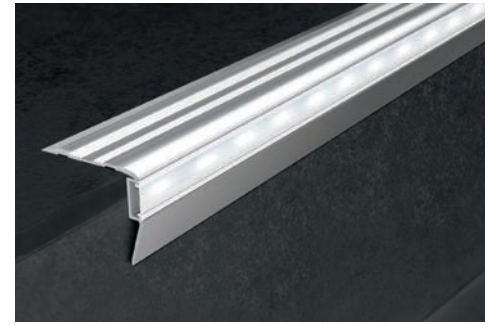

**ANODIZED SILVER ALUMINIUM**  
bar length 2,7 lm - pack. 20 Pcs - 54 lm  
ADAPTOR LED, LED & FLAT NOT INCLUDED

Article	H x L mm
PTRLEDAA 5040	43,5 X 52,5
PTRLEDAA 5040A	43,5 X 52,5
PTRLEDAA 5040F	43,5 X 52,5

"A" at the end of the product code = Item with adhesive  
"F" at the end of the product code = Punched Item

**ADHESIVE FLEXIBLE LED COIL**  
length 5 lm - pack. 1 ROLL

Article
LEDN
LEDF
LEDC

"N" at the end of the product code = neutral light  
"F" at the end of the product code = cold light  
"C" at the end of the product code = hot light

## COLOURS

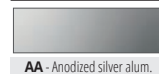

AA - Anodized silver alum.

**POLYCARBONATE FLAT** bar length 2,7 lm - pack. 20 Pcs - 54 lm  
(AL = transparent / AO = matt)

Article
PIAL 17
PIAO 17

**ENDCAPS- R / L** - pack. 6 Pcs (3 R and 3 L)

Article	H x L mm
TPTRLEDAA 5040/3	43,5 X 52,5



**LED ADAPTOR AC/DC 75W - 12V (15 lm)**

Article
ALL 7512

**LED ADAPTOR AC/DC 25W - 12V (5 lm)**

Article
ALL 2512

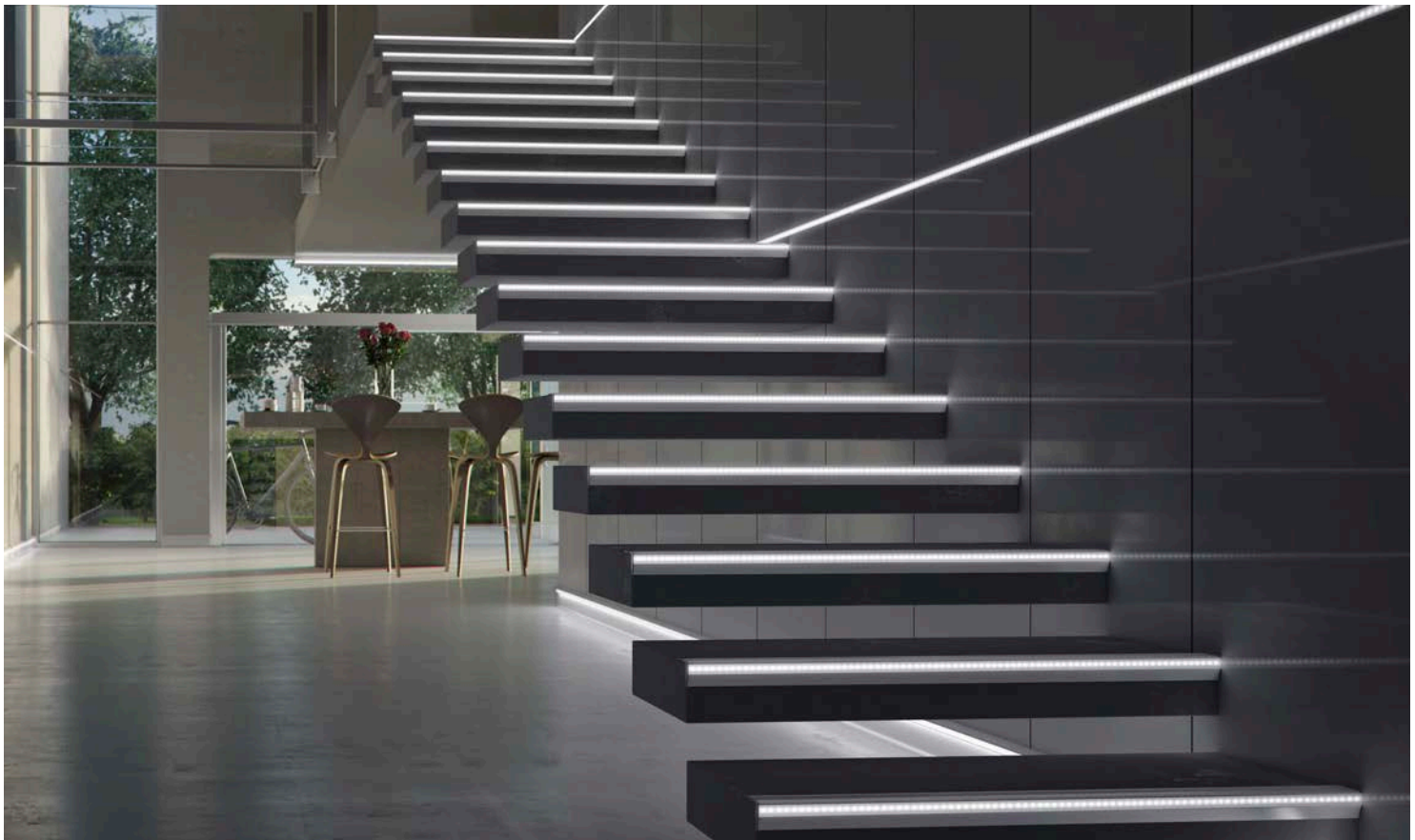





# PROSTYLE

ROUNDED STEP NOSING  
STAINLESS STEEL AISI 304/1.4301-V2A

**PROSTYLE** is a technical/decorative profile in stainless steel AISI 304/1.4301-V2A for ceramic tile/wood steps. Its particular rounded shape has been conceived to create the "torus" of the step, which is normally created with special pieces. Elegant profile for all public/private environments. In order to perfect placing and to look after details, external angles and closing caps are available.

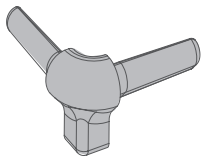
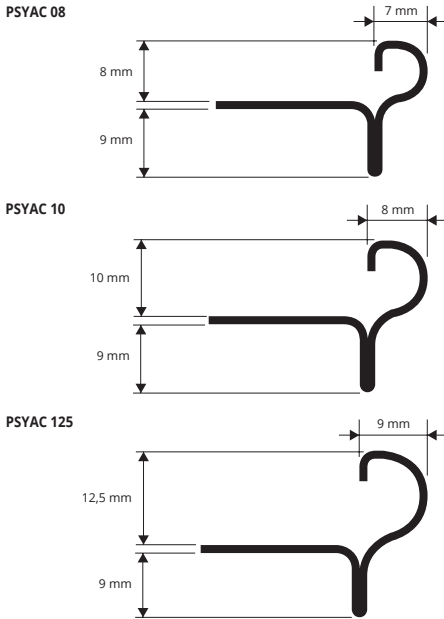

RPSYAC 08/10/125



TPSYAC 08/10/125



**POLISHED STAINLESS ST. AISI 304/1.4301-V2A with protective film**  
bar length 2,7 lm - pack. 20 Pcs - 54 lm - 10/10mm

Article	H mm
PSYAC 08	8
PSYAC 10	10
PSYAC 125	12,5

### COLOURS



AC - Polished stainless st.  
AISI 304/1.4301-V2A

SUITABLE FOR USE IN CONTACT WITH FOODSTUFFS

**VARNISHED PLASTIC STEEL EFFECT JOINT - pack. 20 Pcs**

Article
RPSYAC 08/20
RPSYAC 10/20
RPSYAC 125/20



### EXAMPLES AND INSTRUCTIONS FOR LAYING METHODS



1. Choose the PROSTYLE with suitable height for the thickness of the floor (stairs). 2. Apply the adhesive onto the area of application of the profile. 3. Lay and align the profile, cut to the necessary length, pressing the perforated flange into the adhesive. 4. Lay the tiles, aligning them so that the top edge of the profile is "flush" with the tile. 5. Fill the profile/tile area of contact with adhesive to prevent the accumulation of water in any voids.

**STAINLESS ST. END CAPS H 8 - 10 - 12,5 mm - pack. 20 Pcs**

Article
TPSYAC 08/20
TPSYAC 10/20
TPSYAC 125/20

# PROSTYLE

KNURLED, ROUNDED STEP NOSING  
NATURAL, POLISHED AND CHROMED BRASS

**PROSTYLE** is a technical/decorative profile in natural brass, as well as with polished or chromed finish, for ceramic tile/wood steps. Its particular rounded shape has been conceived to create the "torus" of the step, which is normally created with special pieces. It is knurled on the top to make the profile non-slip. Elegant profile for all public/private environments. Shrink-wrapped profile with bar code.

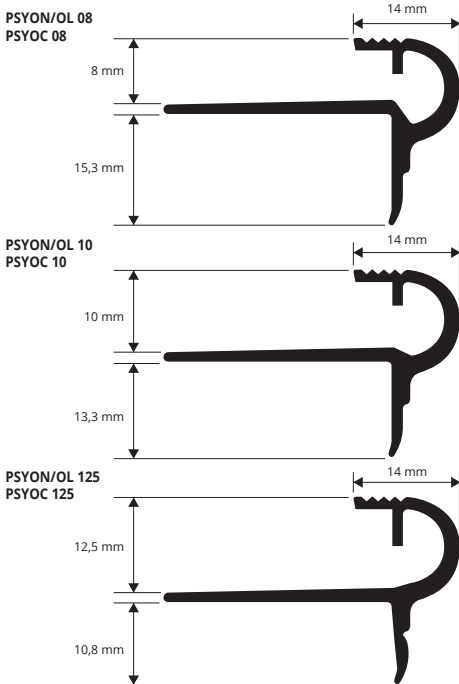

**CHROMED BRASS thermo packed**  
bar length 2,7 lm - pack. 10 Pcs - 27 lm

Article	H mm
PSYOC 08	8
PSYOC 10	10
PSYOC 125	12,5

**NATURAL BRASS thermo packed**  
bar length 2,7 lm - pack. 10 Pcs - 27 lm

Article	H mm
PSYON 08	8
PSYON 10	10
PSYON 125	12,5

**VARNISHED PLASTIC JOINT - pack. 20 Pcs**

Article
RPSYOC 08-10-125/20
RPSYOL 08-10-125/20
RPSYON 08-10-125/20



**POLISHED BRASS thermo packed**  
bar length 2,7 lm - pack. 10 Pcs - 27 lm

Article	H mm
PSYOL 08	8
PSYOL 10	10
PSYOL 125	12,5

**BRASS CAPS H 8 - 10 - 12,5 mm - pack. 20 Pcs**

Article
TPSYOC 08-10-125/20
TPSYOL 08-10-125/20
TPSYON 08-10-125/20

### COLOURS



OC - Chromed brass OL - Polished brass ON - Natural brass



**PROSTYLE** is a technical/decorative profile for ceramic tile/wood steps made in gold-silver anodized aluminium. Its particular rounded shape has been conceived to create the "torus" of the step, which is normally created with special pieces. It is knurled on the top to make the profile non-slip. Elegant profile for all public/private environments. Shrink-wrapped profile with bar code.

# PROSTYLE

KNURLED, ROUNDED STEP NOSING  
GOLD AND SILVER ANODIZED ALUMINIUM

## EXAMPLES AND INSTRUCTIONS FOR LAYING METHODS



1. Choose the PROSTYLE in the required width and colour according to the thickness of the tile.
2. First fix the riser part, placing it at the correct and final height.
3. Fill the empty spaces under the profile with the tile adhesive.
4. Apply the adhesive to the tread, lay the profile with the punched base fully sunk into the adhesive and align the profile so that its vertical part covers the edge of the riser tile.
5. Lay the tread tiles, aligning them so that they are flush with the upper and rear part of the profile and filling the internal part with adhesive. Oxidation marks in the polished/natural brass range may be easily removed with specific chemical products (Sidol-Smac).

## COLOURS

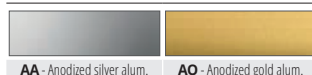

## VARNISHED PLASTIC JOINT - pack. 20 Pcs

Article	
RPSYAO 08/20	*
RPSY... 08-10-125/20	

Universal, suitable for three profile heights

Available: AA - AO.

The code of the selected colour must be added to the article code.

E.g.: RPSY... 08 (chosen colour polished brass) RPSYOL 08



**ANODIZED SILVER ALUMINIUM thermo packed**  
bar length 2,7 lm - pack. 20 Pcs - 54 lm

Article	H mm
PSYAA 08	8
PSYAA 10	10
PSYAA 125	12,5

**ANODIZED GOLD ALUMINIUM thermo packed**  
bar length 2,7 lm - pack. 20 Pcs - 54 lm

Article	H mm
PSYAO 08	8
PSYAO 10	10
PSYAO 125	12,5

## ALUMINIUM CAPS H 8 - 10 - 12,5 mm - pack. 20 Pcs

Article	
TPSYAO 08/20	*
TPSY... 08/20	
TPSY... 10/20	
TPSY... 125/20	

Available: AA - AO.

The code of the selected colour must be added to the article code.

E.g.: TPSY... 08 (chosen colour polished brass) TPSYOL 08.

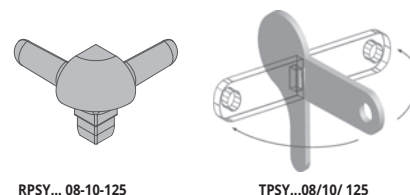
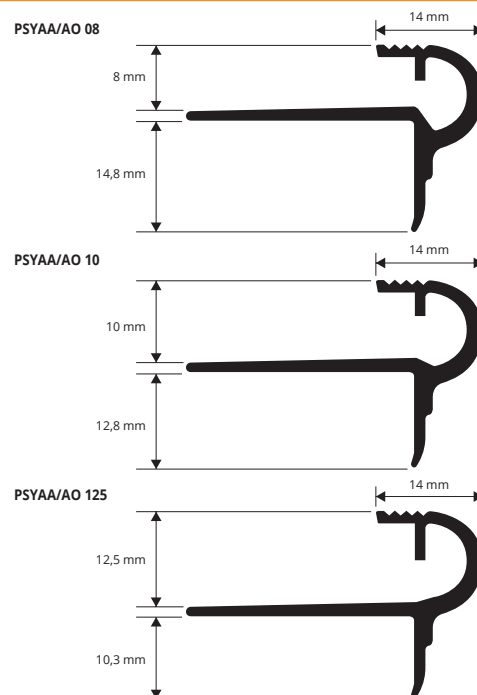

**PROSTEP INS** is a non-slip profile in aluminium that allows to connect the rise and the tread in case of stairs covered with wooden or laminate flooring. The profile has to be laid together with rise and tread. It is equipped with a punched flange that guarantees its fixing. **PROSTEP INS** in anodized aluminium is suitable for any stair covered with wooden flooring.

# PROSTEP INS

ANODIZED SILVER ALUMINIUM

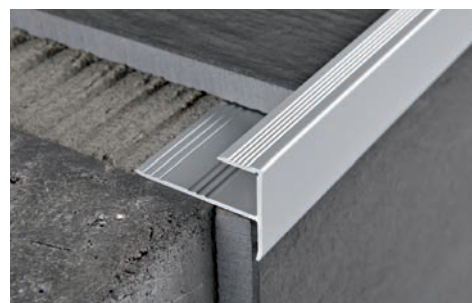

**ANODIZED SILVER ALUMINIUM**  
bar length 2,7 lm - pack. 40 Pcs - 108 lm

Article	H mm
PTSAA 105	10,5
PTSAA 16	16

## COLOURS



## EXAMPLES AND INSTRUCTIONS FOR LAYING METHODS

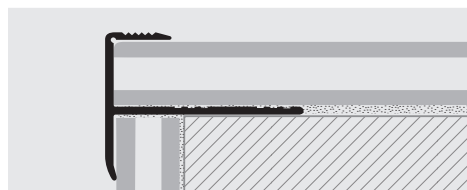

1. Choose "PROSTEP INS" according to the thickness of the tile.
2. Cut "PROSTEP INS" to the desired length.
3. Lay the wood or laminate on the step rise and apply adhesive on the area of the step tread, where the profile will be laid.
4. Lay the profile on the step tread, aligning it with the edge of the rise covering.
5. Lay the wood or laminate on the tread of the step taking care to insert it into the cavity.

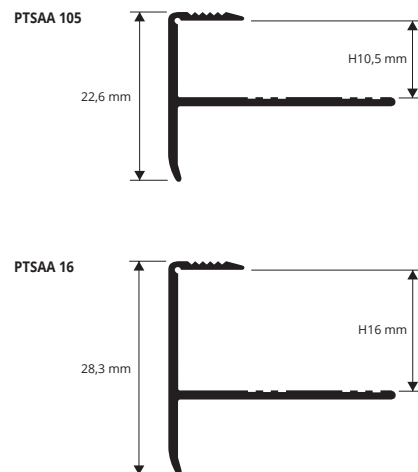

stair nosing profiles

\* = Production on demand with minimum quantity of 100 pcs. Production delay 4/5 weeks. Price to be agreed

# PROSTAIR WOOD

NATURAL OAK  
+ ALUMINIUM BASE

**PROSTAIR WOOD** is a step nosing profile in real oak with aluminium base. Its rounded "torus/convex" shape makes a perfect and elegant nosing for stairs and steps in ceramic-tile-terracotta-wood for indoor and outdoor environments. Attractive. **PROSTAIR WOOD** may be treated and painted subsequently at the time of laying, according to the finishes chosen for the staircase.

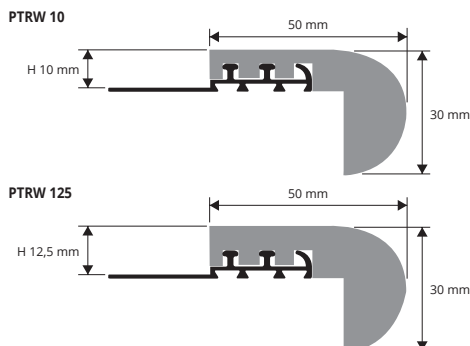

## EXAMPLES AND INSTRUCTIONS FOR LAYING METHODS

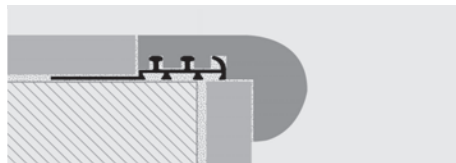

1. Choose the PROSTAIR WOOD with suitable height for the thickness of the covering of the step or staircase. 2. Apply the adhesive onto the area of application of the profile. 3. Lay and align the profile, cut to the necessary length, pressing the perforated flange into the adhesive. 4. Lay the step covering, aligning it so that the top edge of the profile is flush with the covering. 5. Fill the profile/covering area of contact with adhesive to prevent any infiltration.



NATURAL OAK + ALUMINIUM BASE  
bar length 2,7 lm - pack. 10 Pcs - 27 lm

Article	H mm		
PTRW 10	10		
PTRW 125	12,5		

H 15 mm on demand

## COLOURS



NATURAL OAK + ALUMINIUM BASE  
bar length 1,20 lm - pack. 10 Pcs - 12 lm

Article	H mm		
PTRW 1020	10		*
PTRW 12520	12,5		*

NATURAL OAK + ALUMINIUM BASE  
bar length 1,80 lm - pack. 10 Pcs - 18 lm

Article	H mm		
PTRW 1080	10		*
PTRW 12580	12,5		*

**ITEMS SUPPLIED ALREADY ASSEMBLED**  
Treat the wood appropriately with paint or oil.

# PROSTAIR WOOD Z

KNURLED NATURAL OAK  
+ ALUMINIUM BASE

**PROSTAIR WOOD Z** is a step nosing profile in real oak with aluminium base. The rounded shape of the "knurled convex" torus with non-slip surface makes a perfect and elegant nosing for stairs and steps in ceramic-tile-terracotta-wood for indoor and outdoor environments. Attractive. **PROSTAIR WOOD Z** may be treated and painted subsequently at the time of laying, according to the finishes chosen for the staircase.

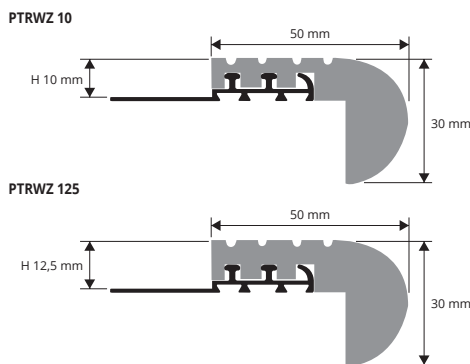

## EXAMPLES AND INSTRUCTIONS FOR LAYING METHODS

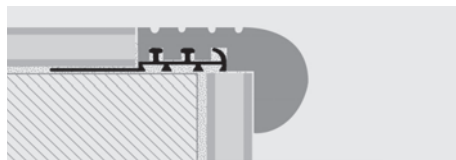

1. Choose the PROSTAIR WOOD Z with suitable height for the thickness of the covering of the step or staircase. 2. Apply the adhesive onto the area of application of the profile. 3. Lay and align the profile, cut to the necessary length, pressing the perforated flange into the adhesive. 4. Lay the step covering, aligning it so that the top edge of the profile is flush with the covering. 5. Fill the profile/covering area of contact with adhesive to prevent any infiltration.



NATURAL OAK + ALUMINIUM BASE  
bar length 2,7 lm - pack. 10 Pcs - 27 lm

Article	H mm		
PTRWZ 10	10		
PTRWZ 125	12,5		

H 15 mm on demand

## COLOURS



NATURAL OAK + ALUMINIUM BASE  
bar length 1,20 lm - pack. 10 Pcs - 12 lm

Article	H mm		
PTRWZ 1020	10		*
PTRWZ 12520	12,5		*

NATURAL OAK + ALUMINIUM BASE  
bar length 1,80 lm - pack. 10 Pcs - 18 lm

Article	H mm		
PTRWZ 1080	10		*
PTRWZ 12580	12,5		*

**ITEMS SUPPLIED ALREADY ASSEMBLED**  
Treat the wood appropriately with paint or oil.

\* = Production on demand with minimum quantity of 100 pcs. Production delay 4/5 weeks. Price to be agreed

**PROSTEP WOOD** is a step nosing profile in real oak with aluminium base. Its 90° shape makes a perfect and elegant nosing for modern stairs and steps in ceramic-tile-terracotta-wood for indoor and outdoor environments. Attractive.

**PROSTEP WOOD** may be treated and painted subsequently at the time of laying, according to the finishes chosen for the staircase.

## PROSTEP WOOD

NATURAL OAK  
+ ALUMINIUM BASE

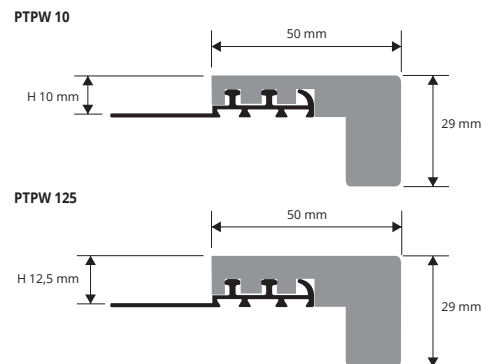

**NATURAL OAK + ALUMINIUM BASE**  
bar length 2,7 lm - pack. 10 Pcs - 27 lm

Article	H mm		
PTPW 10	10		
PTPW 125	12,5		

**NATURAL OAK + ALUMINIUM BASE**  
bar length 1,20 lm - pack. 10 Pcs - 12 lm

Article	H mm		
PTPW 1020	10	*	
PTPW 12520	12,5	*	

**NATURAL OAK + ALUMINIUM BASE**  
bar length 1,80 lm - pack. 10 Pcs - 18 lm

Article	H mm		
PTPW 1080	10		
PTPW 12580	12,5		

### COLOURS



### EXAMPLES AND INSTRUCTIONS FOR LAYING METHODS

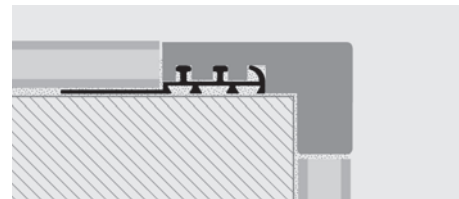

1. Choose the PROSTEP WOOD with suitable height for the thickness of the covering of the step or staircase.
2. Apply the adhesive onto the area of application of the profile.
3. Lay and align the profile, cut to the necessary length, pressing the perforated flange into the adhesive.
4. Lay the step covering, aligning it so that the top edge of the profile is "flush" with the covering.
5. Fill the profile/covering area of contact with adhesive to prevent any infiltration.

### ITEMS SUPPLIED ALREADY ASSEMBLED

Treat the wood appropriately with paint or oil.

**PROSTYLE WOOD** is a step nosing profile in real oak with aluminium base. Its rounded "torus/fret" shape makes a perfect and elegant nosing for stairs and steps in ceramic-tile-terracotta-wood for indoor and outdoor environments. Attractive.

**PROSTYLE WOOD** may be treated and painted subsequently at the time of laying, according to the finishes chosen for the staircase.

## PROSTYLE WOOD

NATURAL OAK  
+ ALUMINIUM BASE

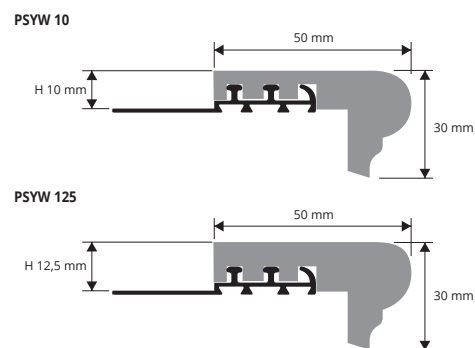

**NATURAL OAK + ALUMINIUM BASE**  
bar length 2,7 lm - pack. 10 Pcs - 27 lm

Article	H mm		
PSYW 10	10		
PSYW 125	12,5		

**NATURAL OAK + ALUMINIUM BASE**  
bar length 1,20 lm - pack. 10 Pcs - 12 lm

Article	H mm		
PSYW 1020	10	*	
PSYW 12520	12,5	*	

**NATURAL OAK + ALUMINIUM BASE**  
bar length 1,80 lm - pack. 10 Pcs - 18 lm

Article	H mm		
PSYW 1080	10	*	
PSYW 12580	12,5	*	

### COLOURS

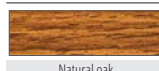

### EXAMPLES AND INSTRUCTIONS FOR LAYING METHODS

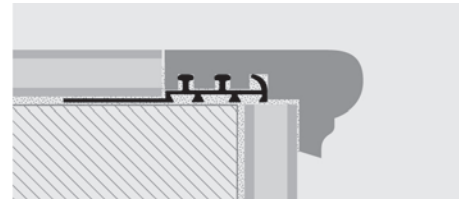

1. Choose the PROSTYLE WOOD with suitable height for the thickness of the covering of the step or staircase.
2. Apply the adhesive onto the area of application of the profile.
3. Lay and align the profile, cut to the necessary length, pressing the perforated flange into the adhesive.
4. Lay the step covering, aligning it so that the top edge of the profile is "flush" with the covering.
5. Fill the profile/covering area of contact with adhesive to prevent any infiltration.

### ITEMS SUPPLIED ALREADY ASSEMBLED

Treat the wood appropriately with paint or oil.

\* = Production on demand with minimum quantity of 100 pcs. Production delay 4/5 weeks. Price to be agreed





**TUBE** and **ACCESSORIES** for runners and stair-carpet guides, available in the finishes in polished painted brass, polished gold aluminium and polished chrome aluminium.

# TUBES and ACCESSORIES

GOLD AND CHROME POLISHED ALUMINIUM  
POLISHED VARNISHED BRASS

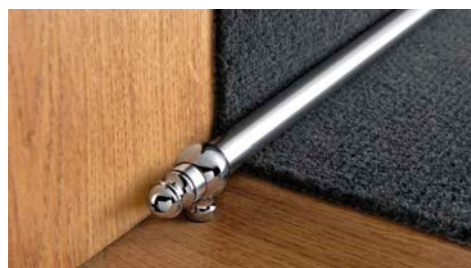

**BLISTER KIT - 2 TUBES AND 4 TUBE PLUGS - POLISHED BRASS COATED**  **SELF-PACK**  
length tube **0,8 lm** - pack. **60 Pcs**

Article	Ø mm		
TCTOL 118S	11		
TCTOL 138S	13		

**BLISTER KIT - 2 TUBES AND 4 TUBE PLUGS - POLISHED BRASS COATED**  **SELF-PACK**  
length tube **0,9 lm** - pack. **60 Pcs**

Article	Ø mm		
TCTOL 119S	11		
TCTOL 139S	13		

**BLISTER KIT - 2 TUBES AND 4 TUBE PLUGS - POLISHED BRASS COATED**  **SELF-PACK**  
length tube **1 lm** - pack. **60 Pcs**

Article	Ø mm		
TCTOL 1110S	11		
TCTOL 1310S	13		

**BLISTER KIT - 2 TUBES and 4 TUBE PLUGS - POLISHED ALUM.**  **SELF-PACK**  
length tube **0,8 lm** - pack. **60 Pcs**

Article	Ø mm		
TCTBO 128S	12		
TCTBC 128S	12		

**BLISTER KIT - 2 TUBES and 4 TUBE PLUGS - POLISHED ALUM.**  **SELF-PACK**  
length tube **0,9 lm** - pack. **60 Pcs**

Article	Ø mm		
TCTBO 129S	12		
TCTBC 129S	12		

**BLISTER KIT - 2 TUBES and 4 TUBE PLUGS - POLISHED ALUM.**  **SELF-PACK**  
length tube **1 lm** - pack. **60 Pcs**

Article	Ø mm		
TCTBO 1210S	12		
TCTBC 1210S	12		

TCTOL 11/13S

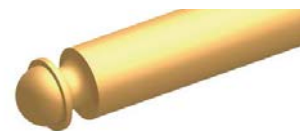

TCTBO 12S

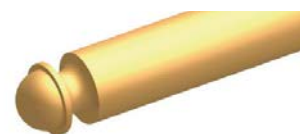

TCTBC 12S



Varnished polished brass is not suitable for places subject to heavy foot-traffic and / or abrasion.

COLOURS



tube and accessories for stairs

## TUBE for runners and stair-carpet guides

GOLD AND CHROME POLISHED ALUMINIUM, POLISHED VARNISHED BRASS

**POLISHED BRASS COATED**  
bar length **2 lm** - pack. **40 Pcs - 80 lm**

Article	Ø mm		
TGSOL 112	11		
TGSOL 132	13		

For different size bars, contact the sales office.

**POLISHED ALUMINIUM**  
bar length **2 lm** - pack. **40 Pcs - 80 lm**

Article	Ø mm		
TGSBO 122	12		
TGSBC 122	12		

TGSOL 11/13



TGSBO 12



TGSBC 12



## TUBE PLUGS/END CAPS for tube

POLISHED BRASS AND CHROMED BRASS

**POLISHED BRASS AND CHROMED BRASS - pack. 60 Pcs**

Article	Ø mm		
TETOL 11	11		
TETOC 12	12		
TETOL 12	12		
TETOL 13	13		

TETOL 11  
TETOL 12  
TETOL 13



TETOC 12



## SUPPORT / EYELET for tube with screw

POLISHED BRASS AND CHROMED BRASS

**POLISHED BRASS AND CHROMED BRASS - pack. 20 Pcs**

Article	Ø mm		
SOOL 12	12		
SOOC 12	12		
SOOL 14	14		

SOOL 12  
SOOL 14



SOOC 12



## HINGE SUPPORT for tube

POLISHED BRASS

**POLISHED BRASS - pack. 20 Pcs**

Article	Ø mm		
SCOL 11	11		
SCOL 13	13		

Articles without bar code.  
For bar code add the letter "C" after the article code. E.g.: SCOL 11C

SCOL 11  
SCOL 13



\* = Production on demand with minimum quantity of 200 pcs. Production delay 4/5 weeks. Price to be agreed



# PROWALK ACC

POLISHED STAINLESS STEEL AISI 304/1.4301-V2A  
PUNCHED OR SELF ADHESIVE

**PROWALK ACC** is steps protecting steel profile for existing scales. Its superior side level is crimped in order to increase its adhesion. Available in version or with holes either with adhesive. Available sizes: 30 x 10, 30 x 20, and 30 x 30 mm. All profiles are protected with protective film. It's ideal for the edges protection and screening as well as of the corner between the rising and the tread which is the point of the greatest strain.

stair nosing for existing steps

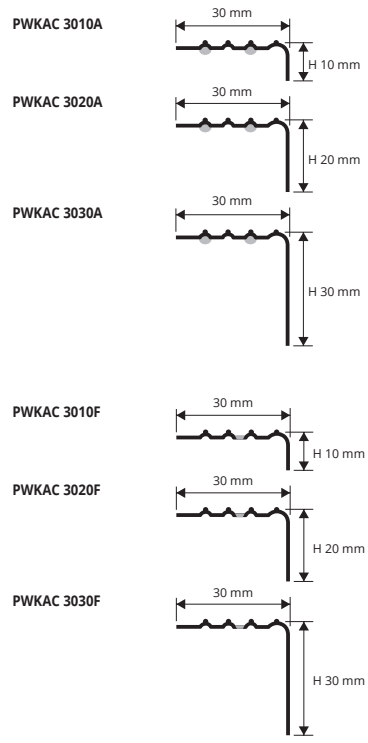

POLISHED STAINLESS STEEL AISI 304/1.4301-V2A with adhesive thermo packed - bar length 2,7 lm - pack. 20 Pcs - 54 lm - 10/10mm

Article	L x H mm		
PWKAC 3010A	30 X 10		
PWKAC 3020A	30 X 20		
PWKAC 3030A	30 X 30		

POLISHED STAINLESS STEEL AISI 304/1.4301-V2A punched - with protective film - bar length 2,7 lm - pack. 20 Pcs - 54 lm - 10/10mm

Article	L x H mm		
PWKAC 3010F	30 X 10		
PWKAC 3020F	30 X 20		
PWKAC 3030F	30 X 30		

### INSTRUCTIONS FOR LAYING METHODS

- Adhesive version**
1. Choose the suitable profile and cut it to the necessary length.
  2. Degrease, wash and clean the solid surface thoroughly.
  3. Remove the protective paper from the adhesive.
  4. Lay the profile by applying pressure evenly over the whole surface without using a hammer.
- Punched version**
1. Choose the suitable profile and cut it to the necessary length.
  2. Mark the position of the holes using the existing holes in the profile as reference.
  3. Insert the screw anchors into the drilled holes.
  4. Fix the profile using flathead screws suitable for the relative slots in the profile.

### COLOURS



**ON DEMAND HAND-BRUSHED STAINLESS STEEL**  
(Price to be agreed.  
Production delay 4/5 weeks)

SUITABLE FOR USE IN CONTACT WITH FOODSTUFFS

# PROEND

GOLD, SILVER AND BRONZE ANOD. ALUMINIUM WITH/ WITHOUT ADHESIVE AND PUNCHED

**PROEND** is a step nosing profile in anodized aluminium with silver-gold-bronze finish, available with self-adhesive backing or punched. Ideal for protecting existing steps and with knurled flat surface, it guarantees excellent safety features to prevent accidents in public and private environments. **PROEND** ensures a perfect finish, covering laying defects and protecting the edge. Easy to lay with the self-adhesive backing ensuring perfect adherence to the step or using screws and screw anchors in the punched version.

stair nosing for existing steps

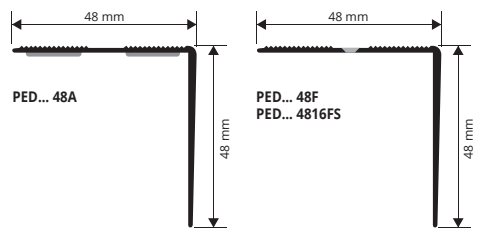

### EXAMPLES AND INSTRUCTIONS FOR LAYING METHODS

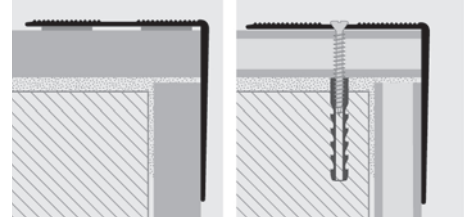

- Adhesive version**
1. Choose the suitable profile and cut it to the necessary length.
  2. Degrease, wash and clean the solid surface thoroughly.
  3. Remove the protective paper from the adhesive.
  4. Lay the profile by applying pressure evenly over the whole surface without using a hammer.
- Punched version**
1. Choose the suitable profile and cut it to the necessary length.
  2. Mark the position of the holes using the existing holes in the profile as reference.
  3. Insert the screw anchors into the drilled holes.
  4. Fix the profile using flathead screws suitable for the relative slots in the profile.

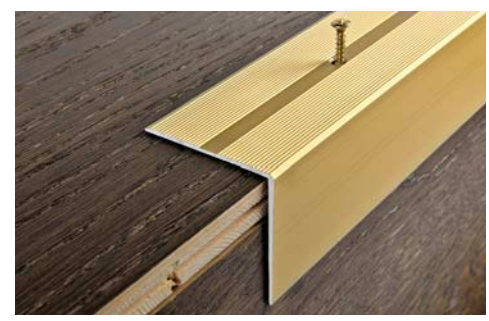

ANOD. ALUMINIUM with and without adhesive thermo packed bar length 2,7 lm - pack. 10 Pcs - 27 lm

Article	H x L mm		
PED... 48A	48 X 48		
PED... 48	48 X 48		

"A" at the end of the product code = Item with adhesive

ANODIZED ALUMINIUM punched thermo packed bar length 2,7 lm - pack. 10 Pcs - 27 lm

Article	H x L mm		
PED... 48F	48 X 48		

On demand bar length 3 lm with minimum quantity of 200 pcs. Production delay 4/5 weeks. Price to be agreed.

### COLOURS

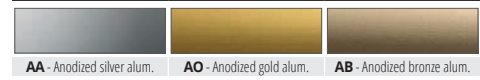

ANOD. ALU. punched with screws and screw anchors thermo packed - bar length 1,65 lm - pack. 20 Pcs SELF PACK

Article	H x L mm		
PED... 4816FS	48 X 48		

Available in the colours: AA - AO - AB. The code of the selected colour must be added to the article code. E.g.: PED... 48A (chosen colour anodized gold) PEDAO 48A.





# PROWALK

**PROWALK** is a step nosing profile in polished brass and anodized aluminium for existing steps. The upper part is knurled to increase slip and slide resistance and is applied after laying. Available with holes or with adhesive. Available in the widths 22 x 22 and 30 x 30 mm. All the profiles are shrink-wrapped. Ideal for protecting and shielding the edges and corner between riser and tread, which are the areas subjected to most stress.

POLISHED BRASS and ANODIZED ALUMINIUM  
ADHESIVE and PUNCHED



**KNURLED POLISHED BRASS with adhesive thermo packed**  
bar length 2,7 lm - pack. 15 Pcs - 40,5 lm

Article	H x L mm		
PWKOL 22A	22 X 22		
PWKOL 30A	30 X 30		

**KNURLED POLISHED BRASS punched thermo packed**  
bar length 2,7 lm - pack. 15 Pcs - 40,5 lm

Article	H x L mm		
PWKOL 22F	22 X 22		
PWKOL 30F	30 X 30		

**KNURLED POLISHED BRASS without holes thermo packed**  
bar length 2,7 lm - pack. 15 Pcs - 40,5 lm

Article	H x L mm		
PWKOL 22	22 X 22		
PWKOL 30	30 X 30		

**KNURLED POLISHED BRASS with adhesive thermo packed** - bar length 0,90 lm - pack. 20 Pcs



Article	H x L mm		
PWKOL 229AS	22 X 22		
PWKOL 309AS	30 X 30		*

**KNURLED POLI. BRASS punched with screws and screw anchors thermo packed** - bar length 0,90 lm - pack. 20 Pcs



Article	H x L mm		
PWKOL 309FS	30 X 30		*

## COLOURS

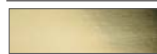

OL - Polished brass

**KNURLED ANODIZED ALUMINIUM with adhesive thermo packed**  
bar length 2,7 lm - pack. 20 Pcs - 54 lm

Article	H x L mm		
PWK... 22A	22 X 22		
PWK... 30A	30 X 30		

**KNURLED ANODIZED ALUMINIUM punched thermo packed**  
bar length 2,7 lm - pack. 20 Pcs - 54 lm

Article	H x L mm		
PWK... 22F	22 X 22		
PWK... 30F	30 X 30		

**KNURLED ANODIZED ALUM. WITHOUT HOLES thermo packed**  
bar length 2,7 lm - pack. 20 Pcs - 54 lm

Article	H x L mm		
PWK... 22	22 X 22		
PWK... 30	30 X 30		

**KNURLED ANODIZED ALUMINIUM with adhesive thermo packed** - bar length 0,90 lm - pack. 20 Pcs



Article	H x L mm		
PWK... 229AS	22 X 22		
PWK... 309AS	30 X 30		*

**KNURLED ANOD. ALU. punched with screws and screw anchors thermo packed** - bar length 0,90 lm - pack. 20 Pcs



Article	H x L mm		
PWK... 229FS	22 X 22		
PWK... 309FS	30 X 30		*

Available in the colours: AO - AA - AB (AT, CH and SB available on demand with a minimum quantity order of 100 pcs). The code of the selected colour must be added to the article code. E.g.: PWK... 22A (chosen colour anodized gold) PWKAO 22A.

## COLOURS

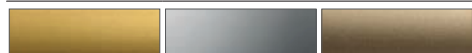

AO - Anodized gold alum. AA - Anodized silver alum. AB - Anodized bronze alum.

**ON DEMAND MINIMUM QUANTITY 100 PCS** for color and height



AT - Anodized titanium alum. CH - Anod. champagne alum. SB - Anodized sand aluminium

PWK... 22A  
PWK... 229AS

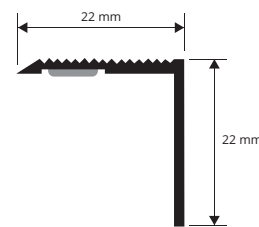

PWK... 30A  
PWK... 309AS

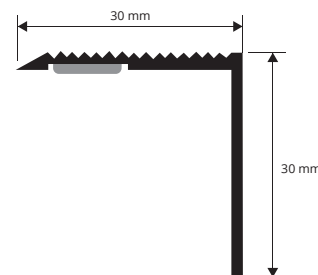

PWK... 22F  
PWK... 229FS

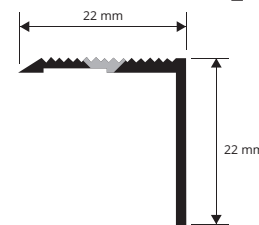

PWK... 30F  
PWK... 309FS

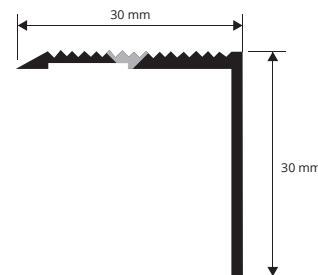

stair nosing for existing steps

## EXAMPLES AND INSTRUCTIONS FOR LAYING METHODS

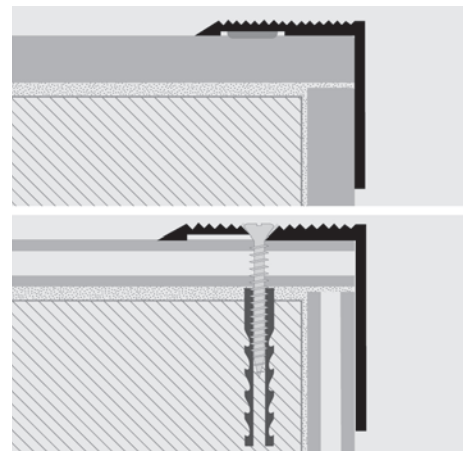

### Adhesive version

1. Choose the suitable profile and cut it to the necessary length.
2. Degrease, wash and clean the solid surface thoroughly.
3. Remove the protective paper from the adhesive.
4. Lay the profile by applying pressure evenly over the whole surface without using a hammer.

### Punched version

1. Choose the suitable profile and cut it to the necessary length.
2. Mark the position of the holes using the existing holes in the profile as reference.
3. Insert the screw anchors into the drilled holes.
4. Fix the profile using flathead screws suitable for the relative slots in the profile.

\* = Production on demand with minimum quantity of 100 pcs. Production delay 4/5 weeks. Price to be agreed

# PROWALK 2510 PROWALK 2520

ALUMINIUM 30 WOOD FINISHES AND 6 ANODIZED FINISHES PUNCHED OR SELF ADHESIVE

**PROWALK 2510 e 2520** are new stair-nosing profiles for existing stairways. Designed to protect and restore stair steps made of wood, laminate, ceramic, etc. Made with anodized aluminium with silver, gold and bronze finish and available in self-adhesive or perforated versions. Sizes available: 2.7 m lengths and 0.9 m & 1.35 m Self-Pack.

stair nosing for existing steps

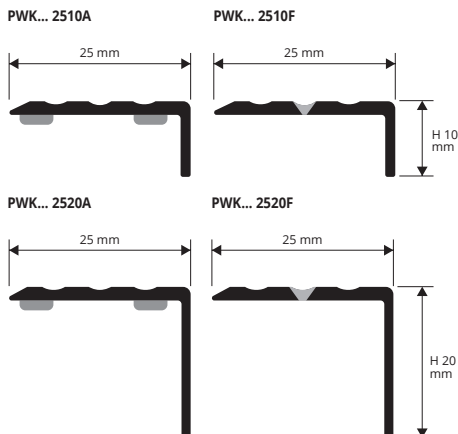

### EXAMPLES AND INSTRUCTIONS FOR LAYING METHODS

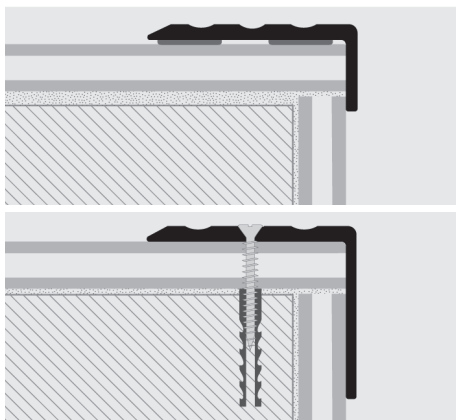

#### Adhesive version

1. Choose the suitable profile and cut it to the necessary length.
2. Degrease, wash and clean the solid surface thoroughly.
3. Remove the protective paper from the adhesive.
4. Lay the profile by applying pressure evenly over the whole surface without using a hammer.

#### Punched version

1. Choose the suitable profile and cut it to the necessary length.
2. Mark the position of the holes using the existing holes in the profile as reference.
3. Insert the screw anchors into the drilled holes.
4. Fix the profile using flathead screws suitable for the relative slots in the profile.



**ANODIZED ALUMINIUM with adhesive thermo packed**  
bar length 2,7 lm - pack. 40 Pcs - 108 lm

Article	L x H mm		
PWK... 2510A	25 X 10		
PWK... 2520A	25 X 20		

**ANODIZED ALUMINIUM with adhesive thermo packed** - bar length 0,90 lm - pack. 20 Pcs



Article	L x H mm		
PWK... 25109AS	25 X 10		



**ANODIZED ALUMINIUM punched thermo packed**  
bar length 2,7 lm - pack. 40 Pcs - 108 lm

Article	L x H mm		
PWK... 2510F	25 X 10		
PWK... 2520F	25 X 20		

**ANODIZED ALUM. punched, screws and screw anchors thermo packed** - bar length 0,90 lm - pack. 20 Pcs



Article	L x H mm		
PWK... 25109FS	25 X 10		

**ANODIZED ALUM. punched, screws and screw anchors thermo packed** - bar length 1,35 lm - pack. 20 Pcs



Article	L x H mm		
PWK... 251013FS	25 X 10		

Available in the finishes: AO - AA - AB (AT, CH e SB on demand with a minimum order of 100 pcs). The code of the selected finish must be added to the article code. E.g.: PWK... 2510A (chosen finish anodized silver) PWKAA 2510A.

**ALUMINIUM WOODEN FINISHES with adhesive thermo packed**  
bar length 2,7 lm - pack. 40 Pcs - 108 lm

Article	L x H mm		
PWK... 2510A	25 X 10		
PWK... 2520A	25 X 20		

Available on demand in the colours: 04W - 05W - 07W - 09W - 13W - 18W - 21W - 25W - 29W - 30W - 31W - 32W - 33W - 34W - 35W - 36W - 37W - 38W - 39W - 41W - 42W - 44W - 45W - 46W - 48W - 49W - 53W - 54W - 55W - 65W - 73W - 75W with a minimum quantity order of 100 pcs. The code of the selected colour must be added to the article code. E.g.: PWK... 2510A (chosen finish dark beech) PWK04 2510A.

### COLOURS

ANODIZED		
AO - Anodized gold alum.	AA - Anodized silver alum.	AB - Anodized bronze alum.

**ON DEMAND MINIMUM QUANTITY 100 PCS** for color and height

(For a precise assessment of colours request the wooden finishes sample range)

ANODIZED									
AT - Anodized titanium alum.	CH - Anod. champagne alum.	SB - Anodized sand aluminium							
04W - Dark beech	05W - Light oak (strip)	07W - Light cherry (strip)	09W - Red walnut (merbau-apple-walnut)	13W - Indonesian teak	18W - Light zerbano	21W - Oak powder	25W - Bleached fir	29W - White oak	
30W - Grey oak	31W - Victoria oak	32W - Pink oak	33W - Sawed oak	34W - Havana oak	35W - Edinburgh oak	36W - American oak	37W - Carvi oak	38W - Queens oak	
39W - Grey elm	41W - Ice oak	42W - Grace oak	44W - Honey oak	45W - Marocco oak	46W - Black decapae'	48W - Cork oak	49W - Sand oak	53W	
54W	55W	65W - Tripoli	73W - Bangkok	75W - Liotard					

On demand it is possible to produce samples of wood finishes. Contact the office for negotiation, small amounts, timing and costs.

\* = Production on demand with minimum quantity of 100 pcs. Production delay 4/5 weeks. Price to be agreed



**PROEND INS 75** is a step nosing profile in anodized aluminium with interchangeable rubber insert: the upper part is knurled to increase slip and slide resistance and is applied after laying. Available anodized with gold, bronze or silver finish and with adhesive or punched.

**PROEND INS 75** ensures a perfect finish, covering laying defects and protecting the edge. Easy to lay with the self-adhesive backing ensuring perfect adherence to the step or with screws and screw anchors in the punched version.

## PROEND INS 75

GOLD, SILVER AND BRONZE ANOD. ALUMINIUM  
ADHESIVE AND PUNCHED

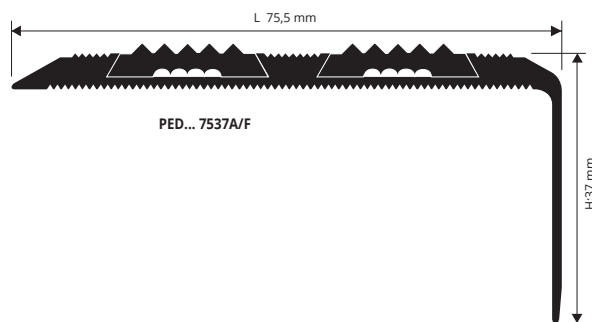

stair nosing for existing steps

**ANODIZED ALUMINIUM with DOUBLE INSERT thermo packed - with adhesive**

bar length 2,7 lm - pack. 10 Pcs - 27 lm

Article	H x L mm
PED... 7537A	37 X 75,5

**ANODIZED ALUMINIUM with DOUBLE INSERT thermo packed - punched**

bar length 2,7 lm - pack. 10 Pcs - 27 lm

Article	H x L mm
PED... 7537F	37 X 75,5

On demand bar length 3 lm with minimum quantity of 200 pcs. Production delay 4/5 weeks. Price to be agreed.

Available in the finishes: AA - AO - AB.  
The code of the selected finish must be added to the article code.  
E.g.: PED... 7537A (chosen finish anodized gold) PEDAO 7537A.

### EXAMPLES AND INSTRUCTIONS FOR LAYING METHODS

#### Adhesive version

1. Choose the suitable profile and cut it to the necessary length. 2. Degrease, wash and clean the solid surface thoroughly. 3. Remove the protective paper from the adhesive. 4. Lay the profile by applying pressure evenly over the whole surface without using a hammer.

#### Punched version

1. Choose the suitable profile and cut it to the necessary length. 2. Mark the position of the holes using the existing holes in the profile as reference. 3. Insert the screw anchors into the drilled holes. 4. Fix the profile using flathead screws suitable for the relative slots in the profile.

### COLOURS

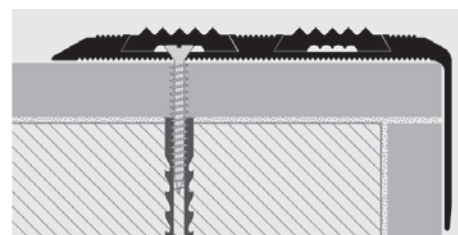
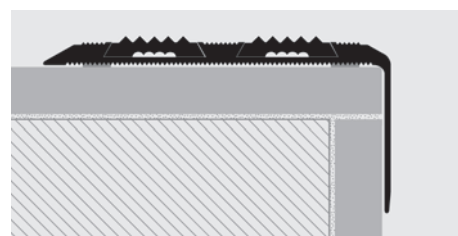

**PROEND INS** is a step nosing profile in anodized aluminium with interchangeable rubber insert: the upper part is knurled to increase slip and slide resistance and is applied after laying. Available anodized with gold, bronze or silver finish and with adhesive or punched.

**PROEND INS** ensures a perfect finish, covering laying defects and protecting the edge. Easy to lay with the self-adhesive backing ensuring perfect adherence to the step or with screws and screw anchors in the punched version.

## PROEND INS

GOLD, SILVER AND BRONZE ANOD. ALUMINIUM  
ADHESIVE AND PUNCHED

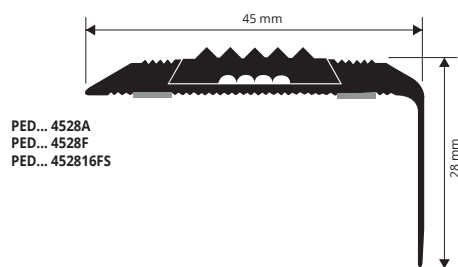
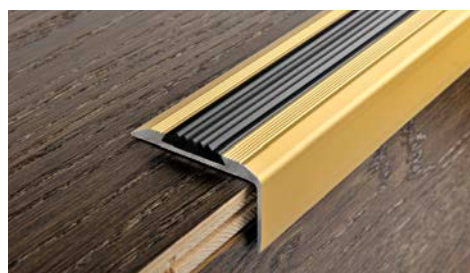

**ANODIZED ALUM. with adhesive WITH INSERT thermo packed**

bar length 2,7 lm - pack. 20 Pcs - 54 lm

Article	H x L mm
PED... 4528A	28 X 45

On demand bar length 3 lm with minimum quantity of 200 pcs. Production delay 4/5 weeks. Price to be agreed.

**AN. ALUM. punched WITH INSERT, screws and screw anchors thermo packed - bar length 1,65 lm - pack. 20 Pcs**



Article	H x L mm
PED... 452816FS	28 X 45

Available in the finishes: AA - AO - AB.  
The code of the selected colour must be added to the article code.  
E.g.: PED... 4528A (chosen finish anodized gold) PEDAO 4528A.

### COLOURS

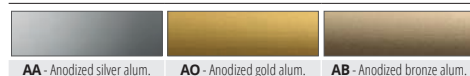

### EXAMPLES OF LAYING

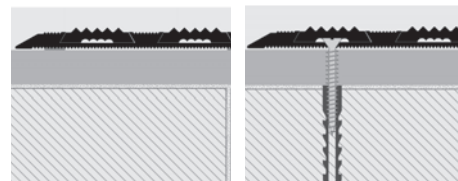

For instructions see the product above

## BLACK INTERCHANGEABLE INSERT

VINYL RESIN / RUBBER

**VINYL RESIN / RUBBER**

bar length 2,7 lm - pack. 20 Pcs - 54 lm

Article
IIN 12

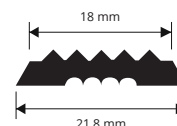

\* = Production on demand with minimum quantity of 100 pcs. Production delay 4/5 weeks. Price to be agreed



# PROEND GRIP 70

SILVER, GOLD AND BRONZE ANOD. ALUMINIUM  
+ NON-SLIP INSERT ADHESIVE AND PUNCHED

**PROEND GRIP 70** is a non-slip step nosing profile in anodized aluminium with adhesive non-slip 50mm thick insert in black carborundum to be fitted in the relative groove in the top of the profile upon completion of laying. The profile may be laid with fixing screws hidden afterwards by the adhesive carborundum, or with silicone and/or adhesive to be applied on the bottom of the profile, which is designed to ensure an excellent grip. It is made in anodized aluminium with silver, gold or bronze finish with anodizing coat of approx. 15/20 micron.

stair nosing for existing steps

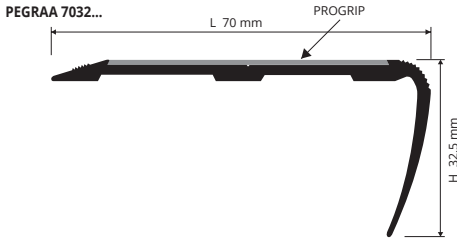

### EXAMPLES AND INSTRUCTIONS FOR LAYING METHODS



#### Adhesive version

1. Choose the suitable profile and cut it to the necessary length.
2. Degrease, wash and clean the solid surface thoroughly.
3. Remove the protective paper from the adhesive.
4. Lay the profile by applying pressure evenly over the whole surface without using a hammer.

#### Punched version

1. Choose the suitable profile and cut it to the necessary length.
2. Mark the position of the holes using the existing holes in the profile as reference.
3. Insert the screw anchors into the drilled holes.
4. Fix the profile using flathead screws suitable for the relative slots in the profile.



SILVER, GOLD AND BRONZE ANODIZED ALUM. with adhesive thermo packed - bar length 2,7 lm - pack. 20 Pcs - 54 lm

Article	H x L mm
PEGR... 7032A	32,5 X 70

SILVER, GOLD AND BRONZE ANODIZED ALUM. punched thermo packed - bar length 2,7 lm - pack. 20 Pcs - 54 lm

Article	H x L mm
PEGR... 7032F	32,5 X 70

Available in the finishes: AA - AO - AB.  
The code of the selected finish must be added to the article code.  
E.g.: PEGR... 7032A (chosen finish anodized gold) PEGRAO. 7032A.

**On demand bar length 3 lm with minimum quantity of 200 pcs. Production delay 4/5 weeks. Price to be agreed.**

**The adhesive carborundum strip (PROGRIP) is not included with the profile.  
For PEGR... 7032... order PGR... 50 (Specify the chosen colour).**

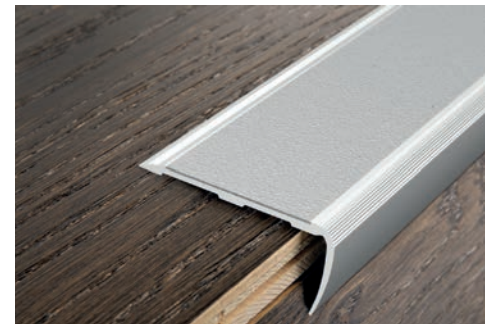

### COLOURS

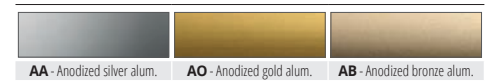

# PROEND 5050

ANODIZED SILVER ALUMINIUM  
+ NON-SLIP INSERT ADHESIVE AND PUNCHED

**PROEND 5050** is a non-slip profile for stairs in anodized silver aluminium, with a visible surface of 50x50 mm. The profile, available in the adhesive or punched version, is characterized of a horizontal surface partially milled, equipped with a specific groove where the non-slip adhesive Progrid in carborundum could be applied. The profile has also a vertical inclined of 83-degrees surface completely smooth. The ease of application and the availability of the carborundum in different colours, make it a much-sought profile.

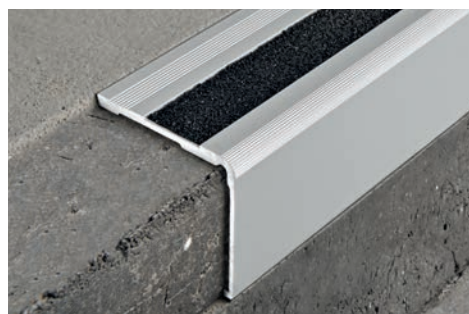
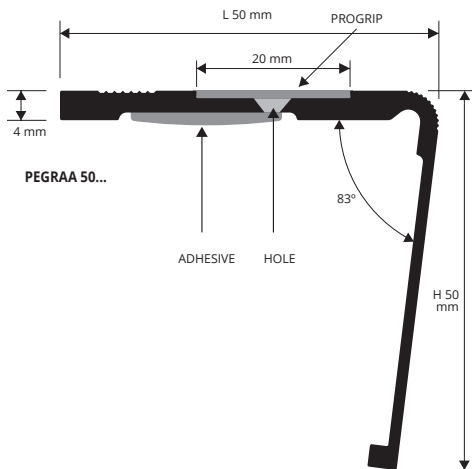

ANODIZED SILVER ALUMINIUM punched / with adhesive bar length 2,7 lm - pack. 20 Pcs - 54 lm

Article	HxL mm
PEGRAA 50F	50 X 50
PEGRAA 50A	50 X 50

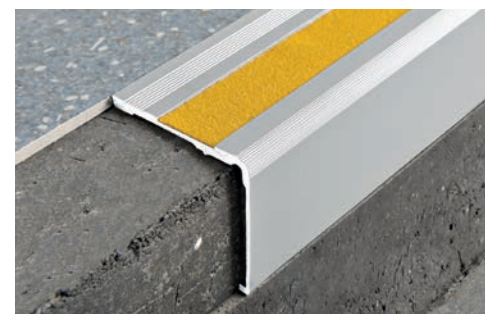

### COLOURS



**On demand bar length 3 lm with minimum quantity of 200 pcs. Production delay 4/5 weeks. Price to be agreed.**

**The adhesive carborundum strip (PROGRIP) is not included with the profile.  
For PEGRAA 50... order PGR... 20 (Specify the chosen colour).**

### INSTRUCTIONS FOR LAYING METHODS

#### Adhesive version

1. Cut PROEND 5050 to the desired length;
2. Remove all the remains of oil, grease and dirt from the surface where the profile will be laid;
3. When the surface is perfectly dry, remove the protective film and press the profile exerting the appropriate pressure;
4. Apply the non-slip strip in carborundum in the desired colour.

#### Punched version

1. Cut PROEND 5050 to the correct size;
2. Mark on the support the position of the holes present on the profile;
3. Drill holes in the bracket with a 5 mm diameter bit and insert the 5 x 25 mm rawlplugs;
4. Align the profiles over the holes and screw it to support;
5. Apply the non-slip carborundum adhesive insert in the desired color.

### EXAMPLES OF LAYING

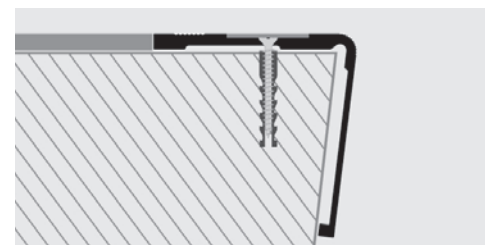

\* = Production on demand with minimum quantity of 100 pcs. Production delay 4/5 weeks. Price to be agreed



**PROEND GRIP** is a non-slip step nosing profile in anodized aluminium with adhesive non-slip 20mm thick insert in black carborundum to be fitted in the relative groove in the top of the profile upon completion of laying. The profile may be laid with fixing screws hidden afterwards by the adhesive carborundum, or with silicone and/or adhesive to be applied on the bottom of the profile, which is designed to ensure an excellent grip. It is made in anodized aluminium with silver, gold or bronze finish with anodizing coat of approx. 15/20 micron.

# PROEND GRIP

SILVER, GOLD AND BRONZE ANOD. ALUMINIUM  
+ NON-SLIP INSERT ADHESIVE AND PUNCHED



ANODIZED SILVER, GOLD AND BRONZE ALUM. with adhesive thermo packed - bar length 2,7 lm - pack 20 Pcs - 54 lm

Article	H x L mm
PEGR... 5230A	30 X 52

On demand bar length 3 lm with minimum quantity of 200 pcs. Production delay 4/5 weeks. Price to be agreed.

ANODIZED SILVER, GOLD AND BRONZE ALUM. with adhesive - thermo packed bar length 1,66 lm - pack 20 Pcs



Article	H x L mm
PEGR... 523016AS	30 X 52

Available in the finishes: AA - AO - AB.

The code of the selected finish must be added to the article code. E.g.: PEGR... 523016AS (chosen finish anodized silver) PEGRAA 523016AS.

The adhesive carborundum strip (PROGRIP) is not included with the profile.  
For PEGR... 5230... order PGR... 20 (Specify the chosen colour).

## COLOURS



\* = Production on demand with minimum quantity of 100 pcs. Production delay 4/5 weeks. Price to be agreed



ANODIZED SILVER, GOLD AND BRONZE ALUM. punched thermo packed - bar length 2,7 lm - pack 20 Pcs - 54 lm

Article	H x L mm
PEGR... 5230F	30 X 52

ANODIZED SILVER, GOLD AND BRONZE ALUM. punched, screws and screw anchors - thermo packed bar length 1,66 lm - Pack 20 Pcs



Article	H x L mm
PEGR... 523016FS	30 X 52

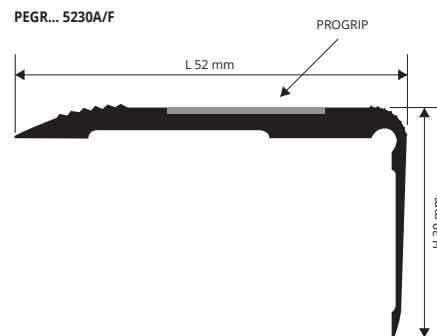

stair nosing for existing steps

## EXAMPLES AND INSTRUCTIONS FOR LAYING METHODS

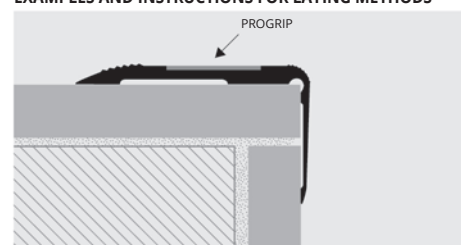

1. Choose the suitable profile for covering the edge of the step.
  2. Clean the surface on which the profile is to be laid, ensuring that it is grease-free and dry. Do not apply the strips at temperatures below 15°.
  3. Remove the protective paper from the adhesive and lay correctly by applying pressure evenly over the whole profile without using a hammer.
- If the punched PROEND GRIP has been chosen, screw the profile to the step and apply the adhesive carborundum to hide the screws.

# PROGRIP

ADHESIVE CARBORUNDUM - 6 COLOURS

**PROGRIP** is a self-adhesive product in carborundum consisting of a plastic film plus abrasive granules with high resistance to wear. It is normally used to guarantee safety on steps in public and private environments, as required by accident-prevention laws. Available in various colours and widths to meet all technical and aesthetic requirements. It is advisable to apply 2 strips on each step, rounding off the ends.

## ADHESIVE CARBORUNDUM NON-SLIP STRIP for STEPS

rolls length 18,2 lm

Article	Width mm
PGRN 20	20
PGRB 20	20
PGRT 20	20
PGRG 20	20
PGRY 20	20
PGRM 20	20
PGRN 25	25
PGRB 25	25
PGRT 25	25
PGRG 25	25
PGRY 25	25
PGRM 25	25
PGRN 50	50
PGRB 50	50
PGRT 50	50
PGRG 50	50
PGRY 50	50
PGRM 50	50

## ADHESIVE NON-SLIP STRIP for STEPS - rolls length 18,2 lm

Article	Width mm
PGRN 20	20
PGRN 25	25
PGRN 50	50



non-slip strip for steps

## LAYING INSTRUCTIONS

1. Thoroughly clean and degrease the surface of application.
2. Round the ends of the strips.
3. Remove the protective paper from the adhesive and lay the PROGRIP using a roller.
4. Do not apply the strips at temperatures below 15°, otherwise heat the strips and the step.
5. When necessary clean away impurities with a brush and preserve the PROGRIP.
6. When laying on tiles, cut and round the corners of the strips on the inner part of the tile.
7. Carefully seal the outer edges of the strips to prevent water infiltration.



## COLOURS

N - Black	B - White	T - Transparent
G - Gray	Y - Yellow	M - Brown

The PGRT (transparent) are not suitable for outside use.

GN - Yellow/Black

News 2021

\* = Production on demand with minimum quantity of 10 rolls. Production delay 4/5 weeks. Price to be agreed

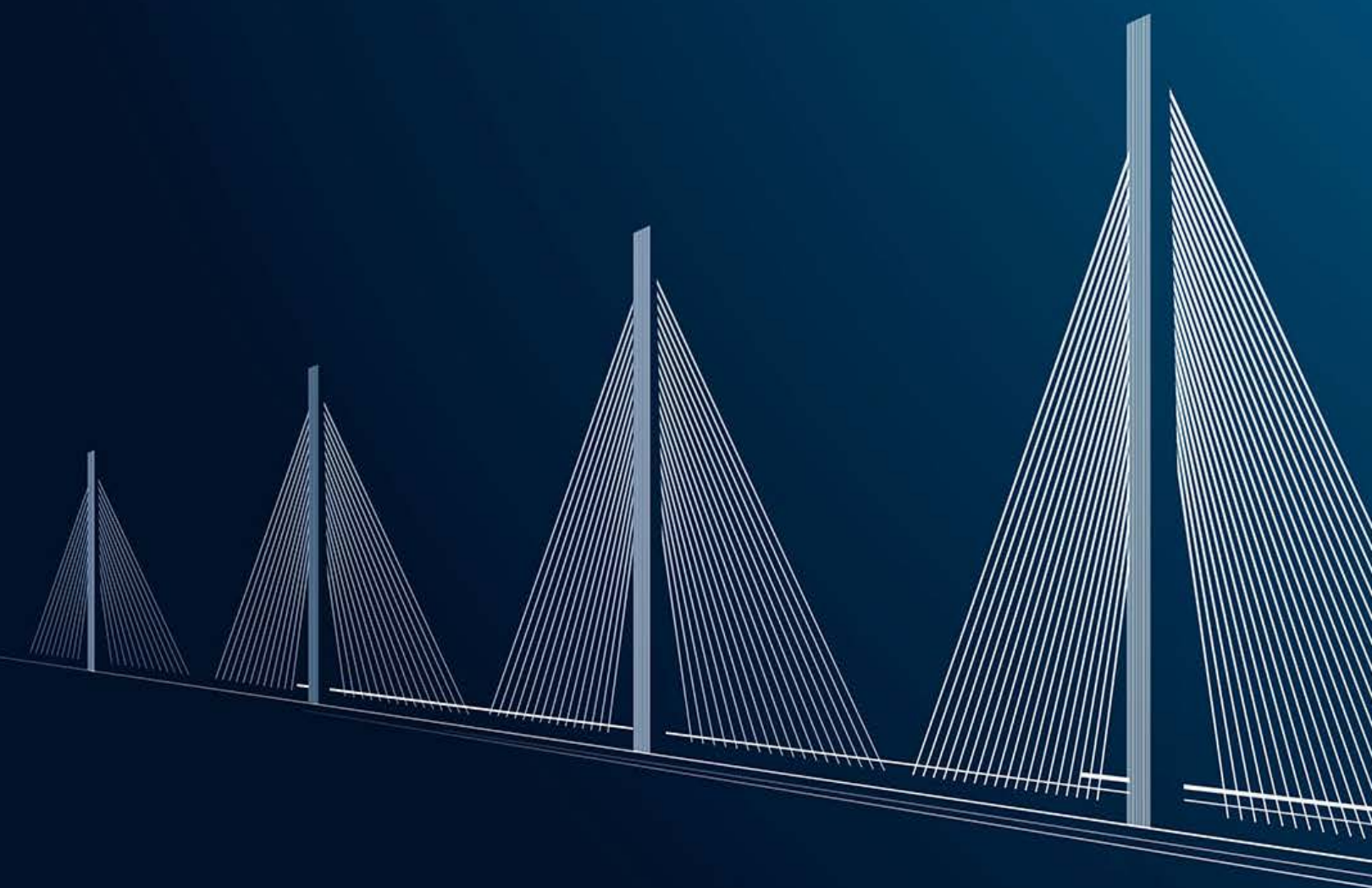

An interpretation of:  
**Milau Bridge, Norman Foster, MILAU (France), 2004**

MOVEMENT AND EXPANSION JOINTS

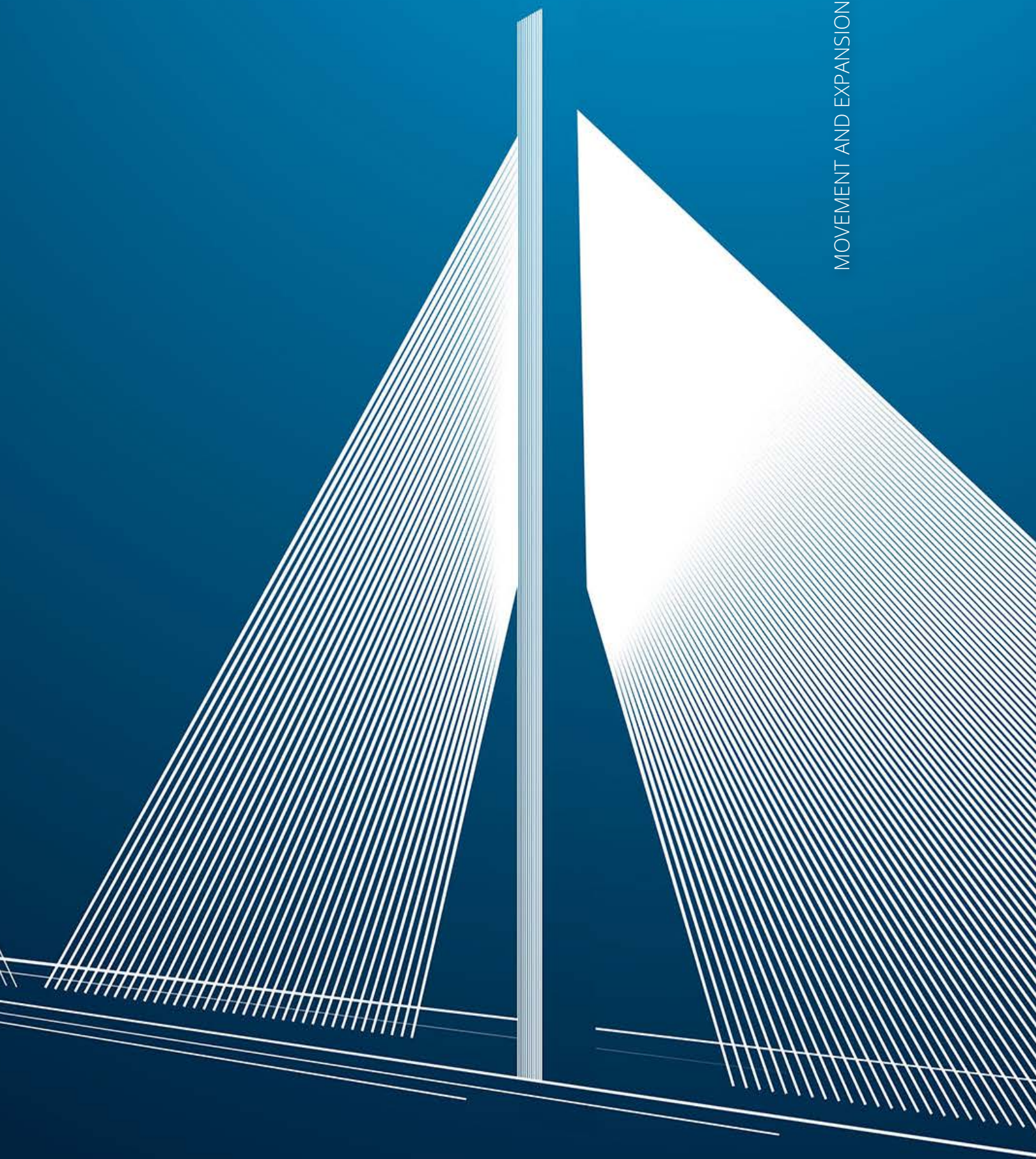

# PROFLEX ACC

STAINLESS STEEL AISI 304/1.4301-V2A  
+ VINYL RESIN / RUBBER INSERT

**PROFLEX ACC** is a new, stainless steel expansion joint with interchangeable (H, 4,5 e 6 mm excluded) vinyl resin/rubber insert, available in black, grey, beige or ivory. **PROFLEX ACC** provides elastic expansion joints for various kinds of flooring, such as ceramic, marble, granite, Kerilite/Laminam or any other flooring material laid with glue/adhesive and having a thickness of 4.5 to 20 mm. The joint is specially designed to protect the edges of the tiles, and its exceptional strength makes it capable of supporting frequent traffic, both pedestrian and vehicular (forklifts, pallet trucks, automobiles). The joint must be installed at the same level of the floor or 0.5-1 mm lower (never above). Lay the joints according with the standards in force. **HIGH RESISTANCE TO LOADS AND TO FREQUENT TRAFFIC OF PALLET TRUCKS AND FORKLIFTS.**

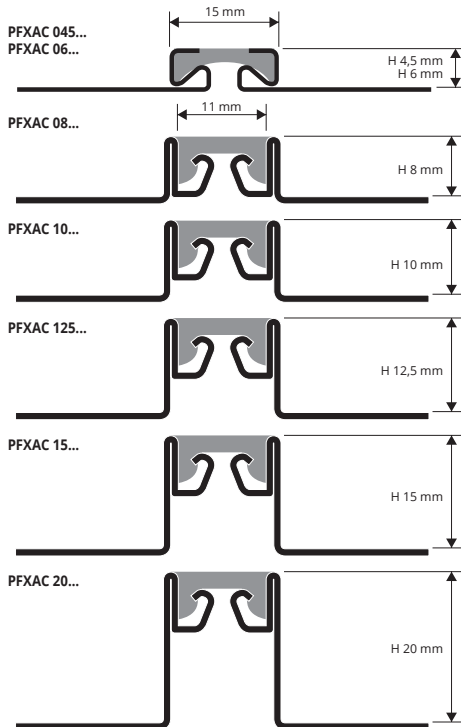

### EXAMPLES OF LAYING

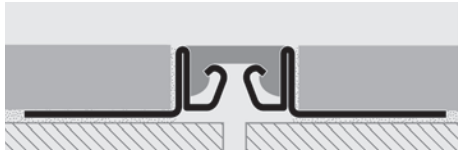

POLISHED STAINLESS STEEL AISI 304/1.4301-V2A  
+ VINYL RESIN / RUBBER INSERT  
bar length 2,5 lm - pack. 10 Pcs - 25 lm (PFXAC 045/06/08 - 50 lm)

Article	H mm
PFXAC 045...	4,5
PFXAC 06...	6
PFXAC 08...	8
PFXAC 10...	10
PFXAC 125...	12,5
PFXAC 15...	15
PFXAC 20...	20

### LAYING INSTRUCTIONS

1. Choose the PROFLEX ACC with the same height as the thickness of the floor (tile) also choosing the colour of the insert. 2. Using a notched spreader apply the adhesive in the point where the joint will be laid. 3. Lay the PROFLEX ACC with the punched flanges in the adhesive (we recommend the expansion joint being laid in line with the joint in the screed/floor rough). 4. Lay the tiles, aligning them with and adjoining the upper edge of the profile (the joint must always be 0.5-1mm lower than the tile, never above). Always place the uncut side of the tile against the profile. 5. Use sealant to fill any spaces between the tile and the PROFLEX ACC joint.



VINYL RESIN/RUBBER INSERT

Article	H mm
ISPFXAC 045...	4,5
ISPFXAC 06...	6

Insert available in the colours: G - N (Beige and ivory available on demand with a minimum quantity order of 200 pcs). The code of the selected finish must be added to the article code. E.g.: PFXAC 045... (chosen insert colour grey) PFXAC 045G.

### COLOURS

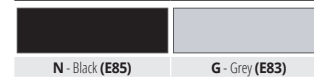

ON DEMAND MINIMUM QUANTITY 200 PCS for colour and height

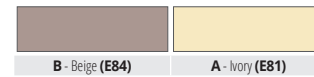

(Price to be agreed. Production delay 4/5 weeks)

# PROFLEX ACC PR

STAINLESS STEEL AISI 304/1.4301-V2A  
+ VINYL RESIN / RUBBER INSERT

**PROFLEX ACC PR** is a new perimeter joint made of AISI 304/1.4301-V2A stainless steel, with an interchangeable vinyl resin/rubber insert. **PROFLEX ACC PR** is applied on fixed parts, such as doors, windows and frames, and also on ceramic tiling, plaster and vertical walls. The visible part of the perimeter joint is the same as PROFLEX ACC, with an exposed steel flange. **PROFLEX ACC PR** joints prevent sound from propagating through the wall lining and reduce the transmission of noise caused by footfalls and vibrations. Available with grey (G), black (N), beige (B) or ivory (A) inserts and in various heights H 8-10-12.5-15-20 mm. Lay the joints according with the standards in force.

soundproof perimeter joints

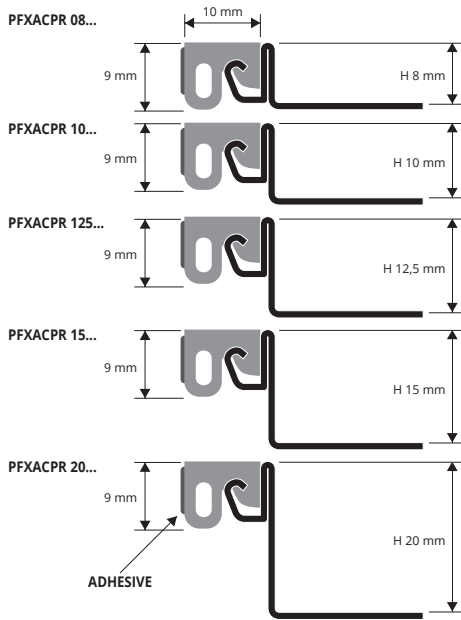

POLISHED STAINLESS STEEL AISI 304/1.4301-V2A  
+ VINYL RESIN / RUBBER INSERT  
bar length 2,5 lm - pack. 20 Pcs - 50 lm

Article	H mm
PFXACPR 08...	8
PFXACPR 10...	10
PFXACPR 125...	12,5
PFXACPR 15...	15
PFXACPR 20...	20

### COLOURS



VINYL RESIN / RUBBER INTERCHANGEABLE INSERT

Article	H mm
ISPFXACPR 820...	8-10-12,5-15-20

Insert available in the colours: G - N (Beige and ivory available on demand with a minimum quantity order of 200 pcs). The code of the selected finish must be added to the article code. E.g.: ISPFXACPR 820... (chosen insert colour grey) ISPFXACPR 820G.

### COLOURS



ON DEMAND MINIMUM QUANTITY 200 pcs for colour and height

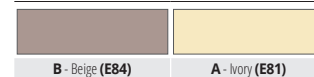

(Price to be agreed. Production delay 4/5 weeks)



**PROFLEX OT** is an expansion joint in natural brass with the interchangeable PVC/rubber insert. It is available in black, grey, beige or ivory and serves to fabricate expansion joints for ceramic tile, marble or granite floors and any floor laid with glue/adhesive between 8 and 20 mm thick. The special structure of the joint is designed to protect the corners of the tiles and its high strength withstands frequent pedestrian and vehicular (lift trucks, pallet trucks, cars) traffic. The joint must be placed level with or 0.5-1 mm below the floor level, never above. Lay the joints according with the standards in force. **HIGH RESISTANCE TO HEAVY LOADS AND TO FREQUENT PALLET TRUCK AND LIFT TRUCK TRAFFIC.**

## PROFLEX OT

NATURAL BRASS  
+ VINYL RESIN / RUBBER INSERT

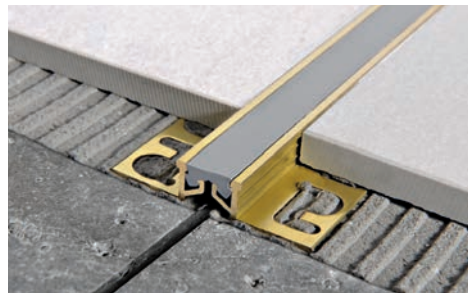

**NATURAL BRASS + VINYL RESIN / RUBBER INSERT**  
bar length 2,5 lm - pack. 10 Pcs - 25 lm

Article	H mm
PFXOT 08...	8
PFXOT 10...	10
PFXOT 125...	12,5
PFXOT 15...	15
PFXOT 20...	20
PFXOT 30...	30

Insert available in the colours: G - N (Beige and ivory available on demand with a minimum quantity order of 200 pcs).  
The code of the selected finish must be added to the article code.  
E.g.: PFXOT 08... (chosen insert colour grey) PFXOT 08G.

### COLOURS



**VINYL RESIN/RUBBER INSERT**

bar length 2,5 lm - pack. 40 Pcs - 100 lm

Article	L x H mm
IGC....	14 X 6

Insert available in the colours: G - N (Beige and ivory available on demand).

The code of the selected finish must be added to the article code.  
E.g.: IGC ... (chosen insert colour grey) IGC G.

\* The inserts of the on demand profiles are also on demand

**ON DEMAND MINIMUM QUANTITY 200 pcs** for colour and height

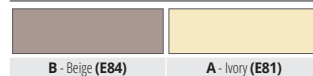

(Price to be agreed. Production delay 4/5 weeks)

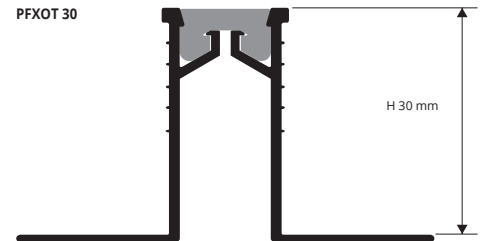

**EXAMPLES AND INSTRUCTIONS FOR LAYING METHODS**

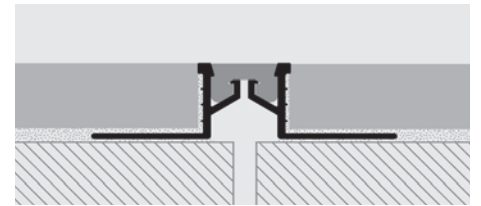

1. Choose the PROFLEX OT with the same height as the thickness of the floor (tile) also choosing the colour of the insert. 2. Using a notched spreader apply the adhesive in the point where the joint will be laid. 3. Lay the PROFLEX OT with the punched flanges in the adhesive (we recommend the expansion joint being laid in line with the joint in the screed/floor rough). 4. Lay the tiles, aligning them with and adjoining the upper edge of the profile (the joint must always be 0.5-1mm lower than the tile, never above). Always place the uncut side of the tile against the profile. 5. Use sealant to fill any spaces between the tile and the PROFLEX OT joint.

**PROFLEX AL** is an expansion joint in natural aluminium with the PVC/rubber insert. It is available in black, grey, beige or ivory and serves to fabricate expansion joints for ceramic tile, marble or granite floors and any floor laid with glue/adhesive between 8 and 20 mm thick. The special structure of the joint is designed to protect the corners of the tiles and its high strength withstands frequent pedestrian and vehicular (lift trucks, pallet trucks, cars) traffic. The joint must be placed level with or 0.5-1 mm below the floor level, never above. Lay the joints according with the standards in force. **HIGH RESISTANCE TO HEAVY LOADS AND TO FREQUENT PALLET TRUCK AND LIFT TRUCK TRAFFIC.**

## PROFLEX AL

NATURAL ALUMINIUM  
+ VINYL RESIN / RUBBER INSERT



**NATURAL ALUMINIUM + VINYL RESIN / RUBBER INSERT**  
bar length 2,5 lm - pack. 20 Pcs - 50 lm

Article	H mm
PFXAL 08...	8
PFXAL 10...	10
PFXAL 125...	12,5
PFXAL 15...	15
PFXAL 20...	20

Insert available in the colours: G - N (Beige and ivory available on demand with a minimum quantity order of 200 pcs).  
The code of the selected finish must be added to the article code.  
E.g.: PFXAL 08... (chosen insert colour grey) PFXAL 08G.

### COLOURS

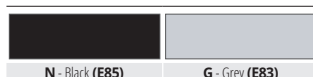

### LAYING INSTRUCTIONS

1. Choose "PROFLEXAL" according to the tile thickness and desired colour. 2. Cut "PROFLEXAL" to the desired length and apply the adhesive on the support where the profile will be laid. 3. Place the joint exactly over the screed joint and press the anchoring flange into the adhesive. 4. Lay the tiles aligning them with the profile leaving a 2 mm joint. After laying the joint should be 0,5 mm below the floor covering surface. Remove immediately all the remains of adhesive from the surface of the profile. 5. Fill the joints between the profile and the tiles with grout, in order to avoid water stagnation. Remove immediately all the remains of grout from the surface of the profile.

**VINYL RESIN/RUBBER INSERT**

bar length 2,5 lm - pack. 40 Pcs - 100 lm

Article	L x H mm
IGC....	14 X 6

Insert available in the colours: G - N (Beige and ivory available on demand).

The code of the selected finish must be added to the article code.  
E.g.: IGC ... (chosen insert colour grey) IGC G.

**ON DEMAND MINIMUM QUANTITY 200 pcs** for colour and height

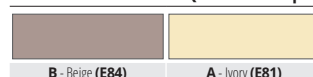

(Price to be agreed. Production delay 4/5 weeks)

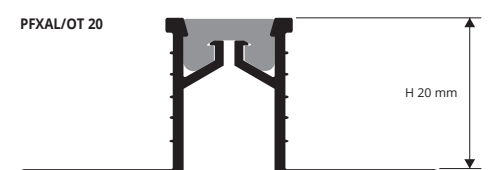
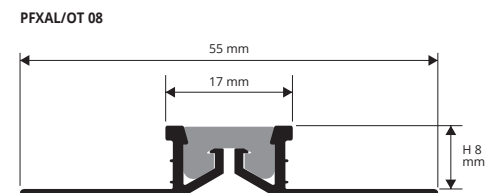

\* = Production on demand with minimum quantity of 200 pcs. Production delay 4/5 weeks. Price to be agreed

# PROFLEX ACN

STAINLESS STEEL AISI 304/1.4301-V2A

**PROFLEX ACN** is a movement joint suitable for vehicular traffic composed by two interlocked sliding stainless steel profiles. The two stainless steel profiles have punched flanges which guarantee a perfect fixing to the support and a correct movement. **PROFLEX ACN** stainless steel is suitable for all areas with heavy chemical and mechanical stress. Lay the joints according to UNI 11493-1.

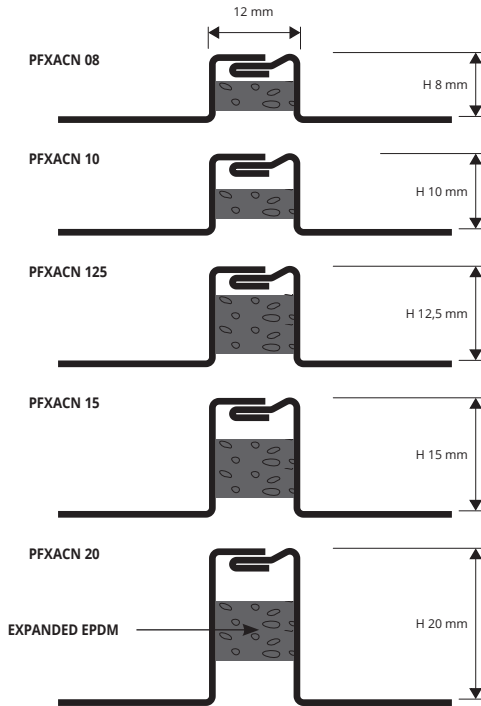

AVAILABLE  
H 11mm - PFXACN 11, H 25mm - PFXACN 25, H 30mm - PFXACN 30



SUITABLE FOR USE IN CONTACT WITH FOODSTUFFS

POLISHED STAINLESS STEEL AISI 304/1.4301-V2A

bar length 2,5 lm - pack. 10 Pcs - 25 lm

Article	H mm		
PFXACN 08	8		
PFXACN 10	10		
PFXACN 11	11		
PFXACN 125	12,5		
PFXACN 15	15		
PFXACN 20	20		
PFXACN 25	25		
PFXACN 30	30		

COLOURS



EXAMPLES AND INSTRUCTIONS FOR LAYING METHODS

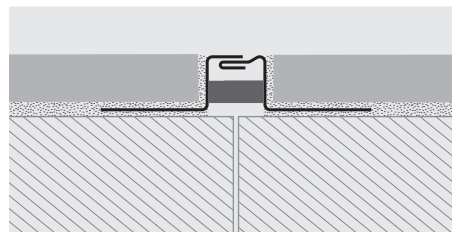

1. Choose the PROFLEX ACN with the same height as the thickness of the floor (tile).
2. Using a notched spreader apply the adhesive in the point where the joint will be laid.
3. Lay the PROFLEX ACN with the punched flanges in the adhesive (we recommend the expansion joint being laid in line with the joint in the screed/floor rough).
4. Lay the tiles, aligning them with and adjoining the upper edge of the profile (the joint must always be 0.5-1mm lower than the tile, never above). Always place the uncut side of the tile against the profile.
5. Use sealant to fill any spaces between the tile and the PROFLEX ACN joint.

# PROFLEX ALN

NATURAL ALUMINIUM

**PROFLEX ALN** is a new, natural aluminium expansion joint consisting of two interlocked sliding profiles designed for glued floors. **PROFLEX ALN** provides elastic expansion joints for various kinds of flooring, such as ceramic, marble, granite, Kerilite or any other flooring material laid with glue/adhesive and having a thickness of 8 to 20 mm. The joint is specially designed to protect the edges of the tiles, and its exceptional strength makes it capable of supporting frequent traffic, both pedestrian and vehicular (forklifts, pallet trucks, automobiles). The joint must be installed at the same level of the floor or 0.5-1 mm lower (never above). Lay the joints according with the standards in force. HIGH RESISTANCE TO LOADS AND TO FREQUENT TRAFFIC OF PALLET TRUCKS AND FORKLIFTS.

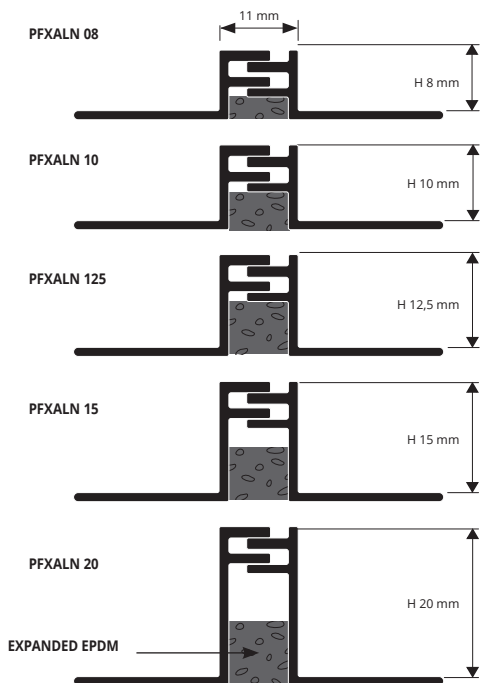

NATURAL ALUMINIUM

bar length 2,5 lm - pack. 20 Pcs - 50 lm

Article	H mm		
PFXALN 08	8		
PFXALN 10	10		
PFXALN 125	12,5		
PFXALN 15	15		
PFXALN 20	20		

COLOURS



EXAMPLES AND INSTRUCTIONS FOR LAYING METHODS



1. Choose the PROFLEX ALN with the same height as the thickness of the floor (tile).
2. Using a notched spreader apply the adhesive in the point where the joint will be laid.
3. Lay the PROFLEX ALN with the punched flanges in the adhesive (we recommend the expansion joint being laid in line with the joint in the screed/floor rough).
4. Lay the tiles, aligning them with and adjoining the upper edge of the profile (the joint must always be 0.5-1mm lower than the tile, never above). Always place the uncut side of the tile against the profile.
5. Use sealant to fill any spaces between the tile and the PROFLEX ALN joint.

**PRODILAT** is an expansion joint in stainless steel inox AISI 304 / 1.4301 – V2A composed of two counterposed profiles in “L” shape, joined with a vulcanized EPDM which can be polished, available in black and grey colour. The counterposed profile in “L” shape have perforated wings for a perfect bond to the substrate and a correct movement of the joint. The expanding EPDM has a high resistance to mechanical & chemical stress, UV rays, to fungi and bacteria. **PRODILAT** in stainless steel is suitable to be used in all environments with high mechanical and chemical stress. Lay the joints according to UNI 11493-1 regulation.

# PRODILAT

STAINLESS STEEL AISI 304/1.4301-V2A WITH SANDABLE VULCANIZED EPDM

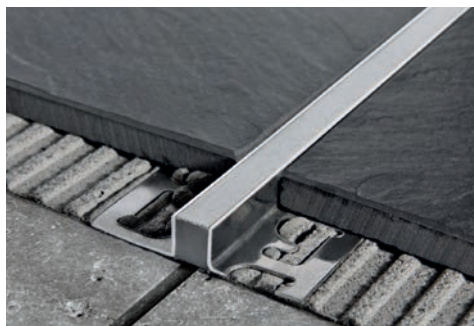

STAINLESS STEEL AISI 304/1.4301-V2A WITH SANDABLE VULCANIZED EPDM - bar length 2,7 lm - pack. 20 Pcs - 54 lm (GCAC 20 - 27 lm)

Article	H mm
GCAC 08... (8x10)	8
GCAC 10... (10x10)	10
GCAC 125... (12,5x10)	12,5
GCAC 15... (15x10)	15
GCAC 20... (20x10)	20

SUITABLE FOR USE IN CONTACT WITH FOODSTUFFS

Possible specks on the surface of the vulcanised rubber are due to the nature of the product itself, they disappear once the laid profile is polished or cleaned. Claims due to these specks will not be taken into consideration.

Insert available in the colours: N - G.  
The code of the selected finish must be added to the article code.  
E.g.: GCAC 08... (chosen insert colour grey) GCAC 08G.  
H 25 / H 30 on demand.

### COLOURS



Stainless steel AISI 304/1.4301-V2A

### COLOURS (EPDM)

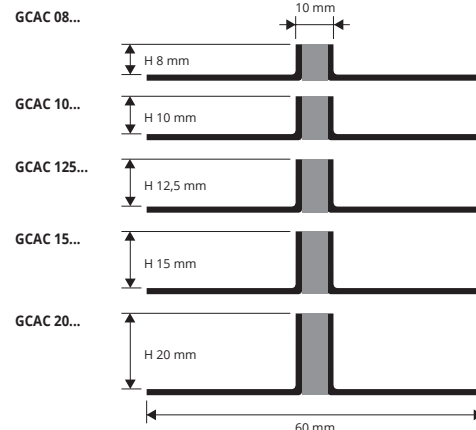

### EXAMPLES AND INSTRUCTIONS FOR LAYING METHODS



1. Choose the PRODILAT with the same height as the thickness of the floor (tile) also choosing the colour of the insert.
2. Using a notched spreader apply the adhesive in the point where the joint will be laid.
3. Lay the PRODILAT with the punched flanges in the adhesive (we recommend the expansion joint being laid in line with the joint in the screed/floor rough).
4. Lay the tiles, aligning them with and adjoining the upper edge of the profile (the joint must always be 0.5-1mm lower than the tile, never above). Always place the uncut side of the tile against the profile.
5. Use sealant to fill any spaces between the tile and the PRODILAT.

**PRODILAT** is an expansion joint in natural aluminium composed of two counterposed profiles in “L” shape, joined with a vulcanized EPDM which can be polished, available in black and grey colour. The counterposed profile in “L” shape have perforated wings for a perfect bond to the substrate and a correct movement of the joint. The expanding EPDM has a high resistance to mechanical & chemical stress, UV rays, to fungi and bacteria. **PRODILAT** in aluminium is suitable to be used in all environments with high mechanical and chemical stress. Lay the joints according to UNI 11493-1 regulation.

# PRODILAT

ALUMINIUM WITH SANDABLE VULCANIZED EPDM

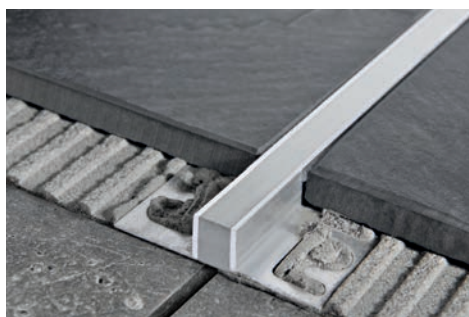

ALUMINIUM WITH SANDABLE VULCANIZED EPDM bar length 2,7 lm - pack. 20 Pcs - 54 lm

Article	H mm
GCAN 08... (8x10)	8
GCAN 10... (10x10)	10
GCAN 125... (12,5x10)	12,5
GCAN 15... (15x10)	15
GCAN 20... (20x10)	20

### COLOURS



Aluminium

### COLOURS (EPDM)



Possible specks on the surface of the vulcanised rubber are due to the nature of the product itself, they disappear once the laid profile is polished or cleaned. Claims due to these specks will not be taken into consideration.

Insert available in the colours: N - G.  
The code of the selected finish must be added to the article code.  
E.g.: GCAN 08... (chosen insert colour grey) GCAN 08G.  
H 25 / H 30 on demand.

### EXAMPLES OF LAYING

1. Choose “PRODILAT” according to the desired finish, tile thickness and desired colour.
2. Cut “PRODILAT” to the desired length and apply the adhesive on the support where the profile will be laid.
3. Place the joint exactly over the screed joint and press the anchoring flange into the adhesive.
4. Lay the tiles, aligning them with the profile leaving a 2 mm. joint. After laying the joint should be 0,5 mm below the floor covering surface. Remove immediately all the remains of adhesive from the surface of the profile.
5. Fill the joints between the profile and the tiles with grout, in order to avoid water stagnation. Remove immediately all the remains of grout from the surface of the profile.

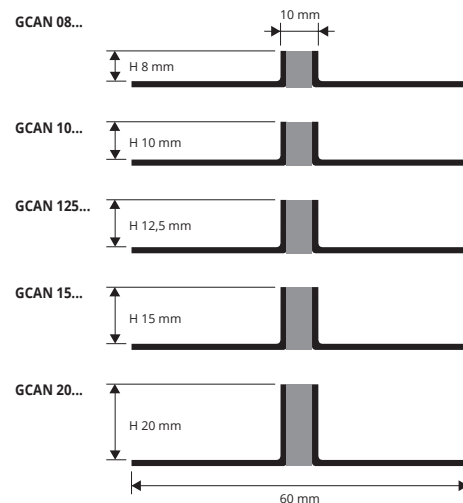

### LAYING INSTRUCTIONS

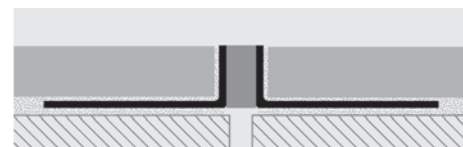

# PROFLEX

NON-TOXIC IMPACT-RESISTANT  
CO-EXTRUDED VINYL RESIN (PVC)

**PROFLEX** is an expansion joint in PVC with PVC/rubber insert. Available in 3 standard colours, **PROFLEX** serves to fabricate expansion joints for ceramic tile, marble or granite floors and any floor laid with glue/adhesive between 8 and 20 mm thick. The special structure of the joint is designed to protect the corners of the tiles and its high strength withstands frequent pedestrian and vehicular (lift trucks - pallet trucks - cars) traffic. The joint must be placed level with or 0.5-1 mm below the floor level, never above. Lay the joints according with the standards in force.

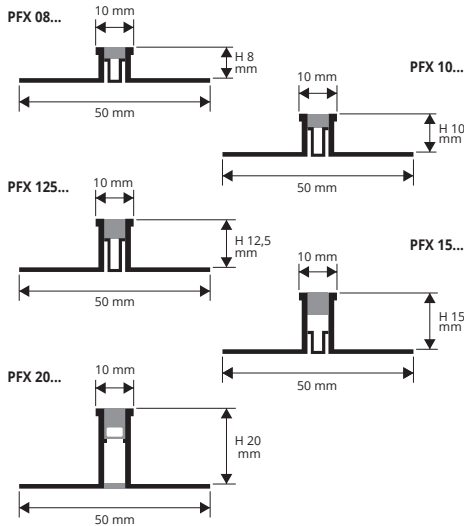

## EXAMPLES AND INSTRUCTIONS FOR LAYING METHODS

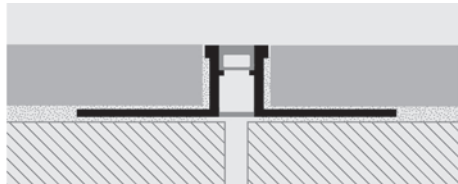

NON - TOXIC CO-EXTRUDED VINYL RESIN - bar length 2,5 lm  
pack. 40 Pcs - 100 lm (PFX 15 and PFX 20 - pack. 20 Pcs)

Article	H mm
PFX 08...	8
PFX 10...	10
PFX 125...	12,5
PFX 15...	15
PFX 20...	20



Available in the colours: GS-GT-GL (Beige and ivory available on demand). The code of the selected finish must be added to the article code. E.g.: PFX 08... (chosen colour dark grey) PFX 08GS.

## COLOURS

GS - Dark grey for rigid and flexible part	GT - Dark grey for rigid part / Transparent for flexible part	GL - Light grey for rigid and flexible part
--	---	---

## ON DEMAND MINIMUM QUANTITY 200 pcs

B - Beige (E84)	A - Ivory (E81)
-----------------	-----------------

(Price to be agreed. Production delay 4/5 weeks)

1. Choose the PROFLEX with suitable height for the thickness of the floor.
2. Apply the adhesive onto the area of application of the profile.
3. Lay and align the profile, cut to the necessary length, pressing the perforated flange into the adhesive.
4. Lay the tiles, aligning them so that the top edge of the profile is flush with the tile.
5. Fill the profile/tile area of contact with adhesive to prevent the accumulation of water in any voids.

# PROFLEX 5

NON-TOXIC IMPACT-RESISTANT  
CO-EXTRUDED VINYL RESIN (PVC)

**PROFLEX 5** is a range of technical expansion joint profiles for floors laid with glue/adhesive. They are made in non-toxic, impact-resistant, co-extruded PVC with perforated horizontal lateral flanges in rigid PVC while the elastic central part is made in flexible vinyl resin 5 mm in width. They are able to absorb moderate tensile and compressive stress, while being resistant to most chemical agents, to wear and to UV rays. They may be used indoors and outdoors. Thanks to the limited widths, **PROFLEX 5** may be considered a "gap cover" because it blends in with the gaps between tiles. The joint profile must never be placed over a tiled floor and should preferably always be 0.5-1 mm lower. Lay the joints according with the standards in force.

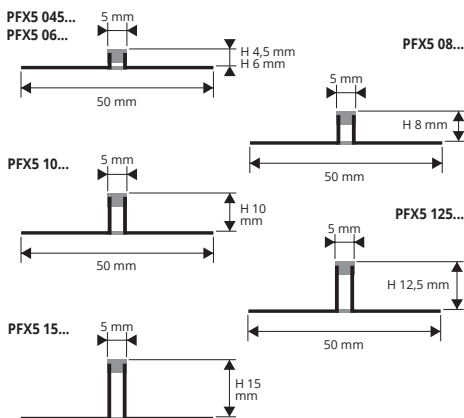

## EXAMPLES AND INSTRUCTIONS FOR LAYING METHODS

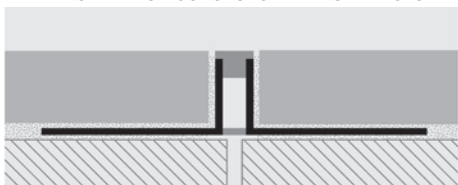

NON - TOXIC CO-EXTRUDED VINYL RESIN - bar length 2,5 lm  
pack. 40 Pcs - 100 lm (PFX5 15 - pack. 20 Pcs - 50 lm)

Article	H mm
PFX5 045...	4,5
PFX5 06...	6
PFX5 08...	8
PFX5 10...	10
PFX5 125...	12,5
PFX5 15...	15



Available in the colours: GS-GL (Beige and ivory available on demand with a minimum quantity order of 200 pcs). The code of the selected finish must be added to the article code. E.g.: PFX5 08... (chosen colour dark grey) PFX5 08GS.

## COLOURS

GS - Dark grey for rigid and flexible part	GL - Light grey for rigid and flexible part
--	---

## ON DEMAND MINIMUM QUANTITY 200 pcs for colour and height

B - Beige (E84)	A - Ivory (E81)
-----------------	-----------------

(Price to be agreed. Production delay 4/5 weeks)

**PROFLEX 5 PR** is a perimeter joint made of coextruded vinyl resin that can be used to connect the floor to the wall lining or the wall lining to doors and windows and/or to any other kind of lining. The 5 mm elastic part (exposed) allows the floor/lining to expand as necessary. **PROFLEX 5 PR** prevents and dampens the propagation of sound waves and the forming of sound bridges. Available in dark grey, light grey, Beige and ivory, in various heights H 4,5-6-8-10-12,5 mm. Lay the joints according with the standards in force.

# PROFLEX 5 PR

NON-TOXIC IMPACT-RESISTANT CO-EXTRUDED VINYL RESIN (PVC)



VINYL RESIN - bar length 2,5 lm - pack. 40 Pcs - 100 lm

Article	H mm
PFX5PR 045...	4,5
PFX5PR 06...	6
PFX5PR 08...	8
PFX5PR 10...	10
PFX5PR 125...	12,5
PFX5PR 15...	15

Available in the colours: GS-GL (Beige and ivory available on demand with a minimum quantity order of 200 pcs). The code of the selected finish must be added to the article code. E.g.: PFX5PR 045... (chosen insert colour dark grey) PFX5PR 045GS.

### COLOURS

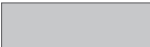
	
GS - Dark grey for rigid and flexible part	GL - Light grey for rigid and flexible part

### EXAMPLES AND INSTRUCTIONS FOR LAYING METHODS

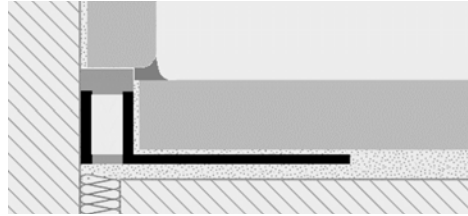

1. Choose "PROFLEX 5 PR" higher than the thickness of the tile
2. Cut "PROFLEX 5 PR" to the desired length and apply the adhesive on the support where the joint will be laid.
3. Position the profile along the perimeter and press the anchoring flap into the adhesive layer.
4. Lay the tiles.
5. Lay the skirting board taking care to rest it on the profile.
6. Silicone between the floor and skirting board

PFX5PR 045...  
PFX5PR 06...



PFX5PR 08...



PFX5PR 10...



PFX5PR 125...



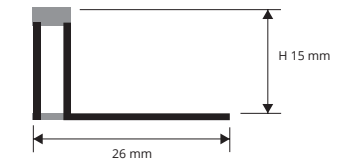

PFX5PR 15...



soundproof perimeter joints

ON DEMAND MINIMUM QUANTITY 200 pcs for colour and height

	
B - Beige (E84)	A - Ivory (E81)

(Price to be agreed. Production delay 4/5 weeks)



\* = Production on demand with minimum quantity of 200 pcs. Production delay 4/5 weeks. Price to be agreed

# ADHESIVE-LAID JOINTS

CO-EXTRUDED VINYL RESIN

**ADHESIVE-LAID MOVEMENT JOINTS** are a range of joints in co-extruded vinyl resin with the flanges and vertical supports made in rigid synthetic vinyl resin and the elastic central part in flexible synthetic vinyl resin. The glue-laid joints must be placed at least 0.5-1 mm below the level of the flooring (usually tiles) and never above. Suitable for pedestrian traffic, they absorb compressive and slip stress. Laying modules between 16 and 30 m<sup>3</sup> inclusive are recommended and the joint laid in line with the joints in the underlying screed. Available in various colours and heights. Lay the joints according with the standards in force.

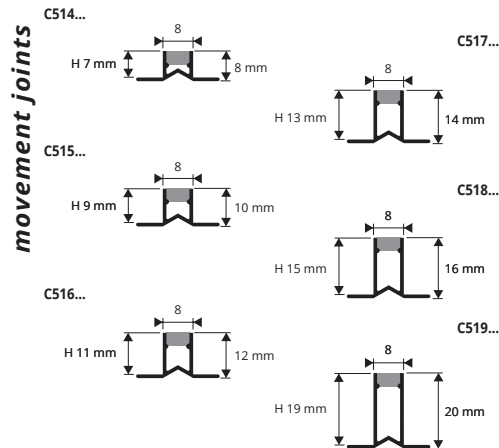

## EXAMPLES AND INSTRUCTIONS FOR LAYING METHODS

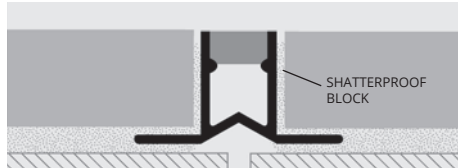

1. Choose the joint in accordance with the colour and thickness of the floor, calculating 0.5-1 mm less for laying the joint, which under no circumstances must protrude. 2. Place the joint over the cut/joint in the screed; if there is none, make a cut of 2/3 the thickness of the screed. 3. Apply the adhesive and lay the joint, pressing it into the glue. 4. Lay the tiles, aligning them with the rigid vertical part of the joint. 5. Using the special glue, fill the gap between the tiles and the profile.



**CO-EXTRUDED VINYL RESIN**  
bar length 2,5 lm - pack. 40 Pcs - 100 lm

Article	H mm		
C514... (8x8)	7		
C515... (10x8)	9		
C516... (12x8)	11		
C517... (14x8)	13		
C518... (16x8)	15		
C519... (20x8)	19		

### ARTICLES NOT FOR SALE SINGLY

Available combinations: GS-GT-GL (RT-MT-BIBI-B-A and N available on demand with a minimum quantity order of 400 pcs). The code of the selected colour must be added to the article code. E.g.: C514... (combination chosen colour Dark Grey / Transparent)

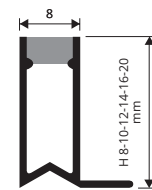

On demand (at same price) also available **WITHOUT FLAP** with a minimum order of 200 pcs. **N.B.:** specify "WITHOUT FLAP" in order.



### COLOURS

GS - Dark grey for rigid and flexible part	GT - Dark grey for rigid part / Transparent for flexible part	GL - Light grey for rigid and flexible part
--	---	---

ON DEMAND - MINIMUM QUANTITY 400 PCS for colour and height

RT - Red for rigid part / Transparent for flexible part	MT - Brown for rigid part / Transparent for flexible part	BIBI - White for rigid and flexible part
B - Beige (E84)	A - Ivory (E81)	N - Black for rigid and flexible part

(Price to be agreed. Production delay 4/5 weeks)

# MORTAR-LAID JOINTS

POLISHED BRASS - STAINLESS STEEL AISI304/1.4301-V2A  
NATURAL ALUMINIUM WITH SANDABLE VULCANIZED EPDM

The **MOVEMENT JOINT** has been specially created to relieve the stress in prestige floors (marble, granite, ceramic tiles or wood) laid on a mortar bed. The joint is simply inserted by hand and is levelled with a plastic hammer. It is available in brass and stainless steel with internal vulcanised expanded EPDM gasket. Strong, practical and top quality. Lay the joints according with the standards in force.

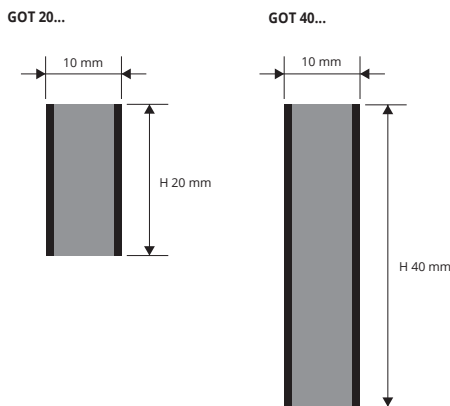

## EXAMPLES AND INSTRUCTIONS FOR LAYING METHODS

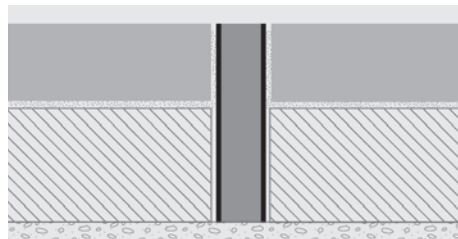

1. Choose the colour and the necessary height of the joint, calculating the thickness of the finished floor and the thickness of the screed. 2. Insert the joint into the screed letting it protrude slightly. 3. Proceed with laying the floor, aligning it with the rigid vertical part of the joint. 4. Complete laying by levelling the joint with the floor. 5. Using the mortar, grout the gap between the tiles and the profile.



**POLISHED BRASS WITH SANDABLE VULCANIZED EPDM**  
bar length 2 lm - pack. 25 Pcs - 50 lm (GOT 40... - 20 lm)

Article	L x H mm		
GOT 20...	10 X 20		*
GOT 40...	10 X 40		

### COLOURS

OL - Polished Brass	AC - Polished Stainless Steel AISI 304/1.4301-V2A	AN - Natural aluminium
---------------------	---	------------------------

### COLOURS (EPDM)

N - Black	G - Grey
-----------	----------



**POLISHED STAINLESS STEEL AISI 304/1.4301-V2A WITH SANDABLE VULCANIZED EPDM**  
bar length 2 lm - pack. 25 Pcs - 50 lm (GAC 40... - 20 lm)

Article	L x H mm		
GAC 20...	10 X 20		*
GAC 40...	10 X 40		*

SUITABLE FOR USE IN CONTACT WITH FOODSTUFFS

**NATURAL ALUMINIUM WITH SANDABLE VULCANIZED EPDM**  
bar length 2 lm - pack. 25 Pcs - 50 lm (GAL 40... - 40 lm)

Article	L x H mm		
GAL 20...	10 X 20		
GAL 40...	10 X 40		

Insert available in the colours: G - N. The code of the selected finish must be added to the article code. E.g.: GAC 20... (chosen insert colour grey) GAC 20G.

**MORTAR-LAID MOVEMENT JOINTS** are a range of joints in co-extruded vinyl resin with the flanges and vertical supports made in rigid synthetic vinyl resin and the elastic central part in flexible synthetic vinyl resin. The mortar-laid joints must be placed at least 0.5-1mm below the level of the ceramic tile-marble-granite floor and never above. Suitable for pedestrian traffic, they absorb compressive and slip stress. Laying modules between 16 and 30 m<sup>3</sup> inclusive are recommended and the joint laid in line with the joints in the underlying screed. Available in various colours and heights. Lay the joints according with the standards in force.

# MORTAR-LAID JOINTS

CO-EXTRUDED VINYL RESIN



## CO-EXTRUDED VINYL RESIN

bar length 2,5 lm - pack. 40 Pcs - 100 lm (C513 - pack. 50 lm)

Article	L x H mm
C511...	8 X 25
C512...	8 X 35
C513...	8 X 45

### ARTICLES NOT FOR SALE SINGLY

Available combinations: GS-GT-GL (RT-MT-BIBI-B-A and N available on demand with a minimum quantity order of 400 pcs). The code of the selected colour must be added to the article code. E.g.: C511... (combination chosen colour dark grey/transparent) C511 GT.

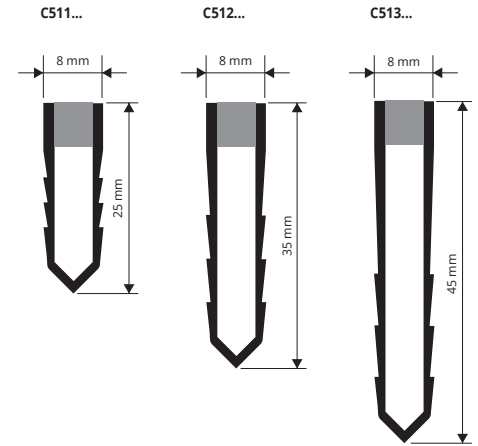

movement joints

## COLOURS



ON DEMAND MINIMUM QUANTITY 400 PCS for colour and height

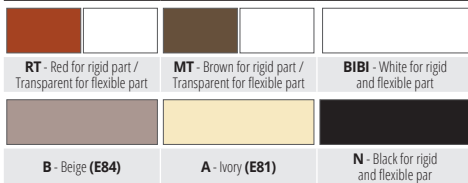

(Price to be agreed. Production delay 4/5 weeks)

## EXAMPLES OF LAYING

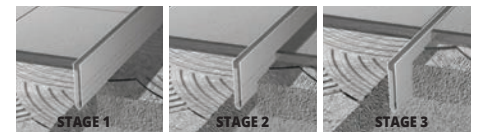
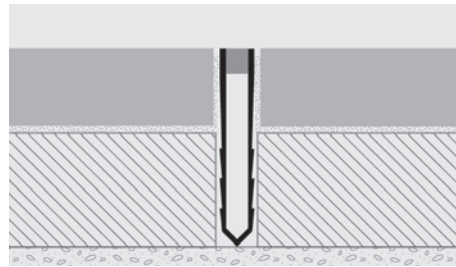

1. Choose the colour and the necessary height of the joint, calculating the thickness of the finished floor and the thickness of the screed.
2. Insert the joint into the screed letting it protrude slightly (stage 1-2-3).
3. Proceed with laying the floor, aligning it with the rigid vertical part of the joint.
4. Complete laying by levelling the joint with the floor.
5. Using the mortar, grout the gap between the tiles and the profile.

This **DOUBLE SILICONE JOINT** is a co-extruded profile in hard and soft PVC. The double internal silicone provides a high degree of resistance to any type of compressive stress, heavy loads and foot traffic. The extension is designed to lengthen the joint, extending it to the total depth of auxiliary or insulation castings as required. Lay the joints according with the standards in force.

# MORTAR-LAID DOUBLE JOINT

VINYL RESIN CO-EXTRUSION (PVC)



## CO-EXTRUDED VINYL RESIN (PVC) WITH DOUBLE SILICONE

bar length 2,5 lm - pack. 40 Pcs - 100 lm (GDSP 43 - CONF. 50 lm)

Article	L x H mm
GDSP 43...	10 X 43
GDS 23...	10 X 25
GP 20	8 X 20

### ARTICLES NOT FOR SALE SINGLY

Available combinations: GS - GT - GL. The code of the selected colour must be added to the article code. E.g.: GDSP 43... (combination chosen colour dark grey/transparent) GDSP 43GT.

## COLOURS



## EXAMPLES AND INSTRUCTIONS FOR LAYING METHODS

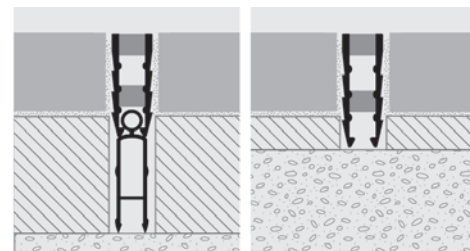

## GDSP 43...

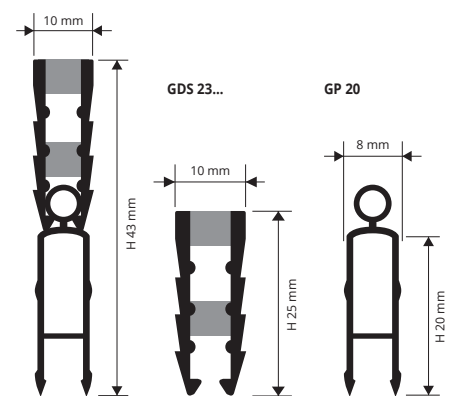

movement joints

1. Choose the colour and the necessary height of the joint, calculating the thickness of the finished floor and the thickness of the screed.
2. Insert the joint into the screed letting it protrude slightly.
3. Proceed with laying the floor, aligning it with the rigid vertical part of the joint.
4. Complete laying by levelling the joint with the floor.
5. Using the mortar, grout the gap between the tiles and the profile.

# MORTAR LAYING FULL JOINT

CO-EXTRUDED VINYL RESIN (PVC)  
WITH FULL SILICONE

**FULL SILICONE JOINT** is a co-extruded profile in hard and soft PVC. The double internal silicone provides a high degree of resistance to any type of compressive stress, heavy loads and foot traffic. The extension is designed to lengthen the joint, extending it to the total depth of auxiliary or insulation castings as required. Lay the joints according with the standards in force.

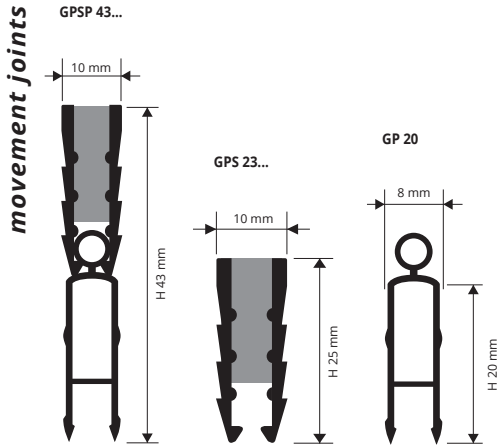

CO-EXTRUDED VINYL RESIN (PVC) WITH FULL SILICONE  
bar length 2,5 lm - pack. 40 Pcs - 100 lm

Article	L x H mm
GPSP 43...	10 x 43
GPS 23...	10 x 25
GP 20	8 x 20

COLOURS

GS	GT	GL
Dark grey for rigid and flexible part	Dark grey for rigid part / Transparent for flexible part	Light grey for rigid and flexible part

EXAMPLES AND INSTRUCTIONS FOR LAYING METHODS

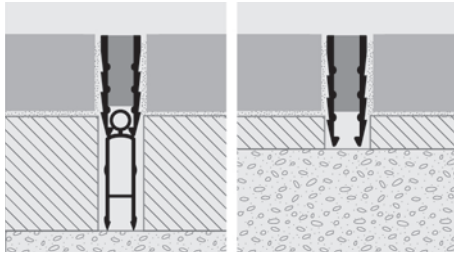

ARTICLES NOT FOR SALE SINGLY

The code of the selected colour must be added to the article code.  
E.g.: GPSP 43... (combination chosen colour dark grey/transparent) GPSP 43GT.

1. Choose the colour and the necessary height of the joint, calculating the thickness of the finished floor and the thickness of the screed.
2. Insert the joint into the screed letting it protrude slightly.
3. Proceed with laying the floor, aligning it with the rigid vertical part of the joint.
4. Complete laying by levelling the joint with the floor.
5. Using the mortar, grout the gap between the tiles and the profile.

# PROFLEX 25

NON-TOXIC IMPACT-RESISTANT  
CO-EXTRUDED VINYL RESIN

**PROFLEX 25 H 25 mm** is a new expansion joint made of coextruded vinyl resin available in two standard colours - dark grey (GS) and light grey (GL). **PROFLEX 25 H 25 mm** provides elastic expansion joints for various kinds of flooring, such as marble or granite, and especially floors made with Sasso Italia. The new decorative indoor and outdoor flooring also known as SASSO ITALIA is approx. 25 mm thick and laid over a 10-20 mm base of cement/ concrete. This kind of floor needs an expansion/control joint every 16-30 m<sup>3</sup> of material to avoid cracking caused by the floor's expansion. PROFLEX H 25 mm lets you place a GP 20 EXTENSION JOINT at the bottom in order to apply/lay the joint inside the concrete base. It can withstand the frequent passage of pedestrians and vehicles (forklifts, pallet trucks, automobiles). The joint must be installed at the same level of the floor or 0.5-1 mm lower (never above). Lay the joints according with the standards in force. HIGH RESISTANCE TO LOADS AND TO FREQUENT TRAFFIC OF PALLET TRUCKS AND FORKLIFTS.

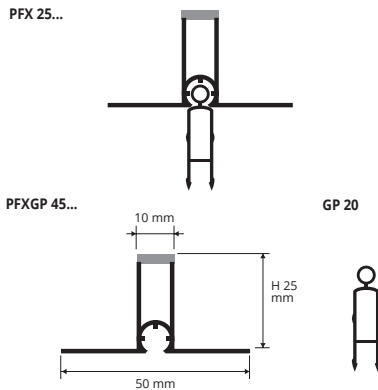

CO-EXTRUDED VINYL RESIN  
bar length 2,5 lm - pack. 20 Pcs - 50 lm

Article	H mm
PFXGP 45...	45
PFX 25...	25
GP 20	20

COLOURS

GS	GL
Dark grey for rigid and flexible part	Light grey for rigid and flexible part

EXAMPLES AND INSTRUCTIONS FOR LAYING METHODS

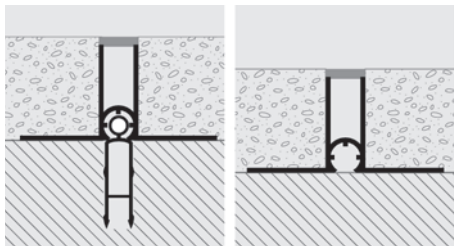

1. Choose the colour of the joint. **1a:** For the version with the extension, insert it onto the fresh cement base leaving the cylindrical part out, for subsequent fitting with PROFLEX 25. **2.** Place and fix with screws/nails to the cement floor and snap the PROFLEX 25 into protruding extension. **3.** Begin laying the floor from the inside, near the joint aligning it with the edges. **4.** Finish laying the floor by levelling the joint with the floor. **5.** Plaster the gap between floor and joint with specific mortar.

The code of the selected colour must be added to the article code.  
E.g.: PFX 25 .. (chosen colour dark grey) PFX 25GS.

\* = Production on demand with minimum quantity of 100 pcs. Production delay 4/5 weeks. Price to be agreed



**PROEXPAN 115-130-190-210** is a range of structural expansion joints in natural aluminium with knurled flat surface and a black or grey synthetic rubber insert. Made to withstand vertical, horizontal and transversal structural movements due to compressive and tensile stress in large buildings or complexes. The joint is laid on existing surfaces, also vertically, over the void between the two semi-detached surfaces of the same building or between two bays. It withstands frequent pedestrian traffic and also vehicles with rubber tyres that can load to 700 kgs. (PENF 190-210)

# PROEXPAN 115-130-190-210

NATURAL ALUMINIUM  
+ VINYL RESIN / RUBBER INSERT



**NATURAL ALUMINIUM + VINYL RESIN / RUBBER INSERT**  
bar length 2,7 lm - pack. 10 Pcs - 27 lm

Article	LxHxLa mm
PENF 115...	21 x 12 x 115
PENF 130...	38 x 12 x 128

**NATURAL ALUMINIUM + NEOPRENE INSERT**  
bar length 3 lm - pack. 10 Pcs - 30 lm

Article	LxHxLa mm
PENF 190N	65 x 19 x 185
PENF 210...	90 x 19 x 210

Movement mm: -10/+16 (PENF 190N) -15/+10 (PENF 210...)  
Available in the colours: G - N (PENF 190N excluded).  
The code of the selected finish must be added to the article code.  
E.g.: PENF 130... (chosen insert colour grey) PENF 130G.

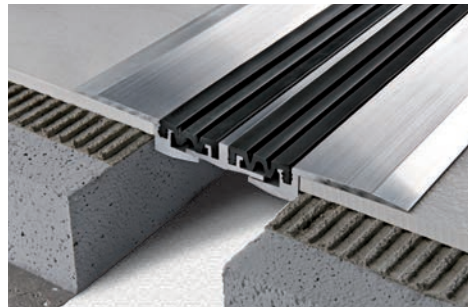

**INTERCHANGEABLE INSERT IN VINYL RESIN/RUBBER INSERT**  
BLACK OR GREY - bar length 3 lm - pack. 10 Pcs - 30 lm

Article	L mm
IPEN 20...	20
IPEN 40...	35

**INTERCHANGEABLE NEOPRENE INSERT BLACK OR GREY**  
bar length 4 lm - pack. 10 Pcs - 40 lm

Article	L mm
IPEN 65N	65
IPEN 452...	45 x 2

Insert available in the colours: G - N (IPEN 65N excluded).  
The code of the selected finish must be added to the article code.  
E.g.: IPEN 20... (chosen insert colour grey) IPEN 20G.

PENF 115...

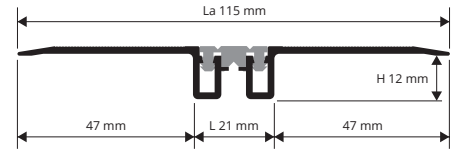

PENF 130...

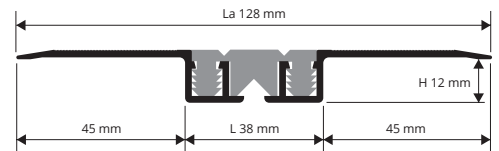

### EXAMPLES AND INSTRUCTIONS FOR LAYING METHODS

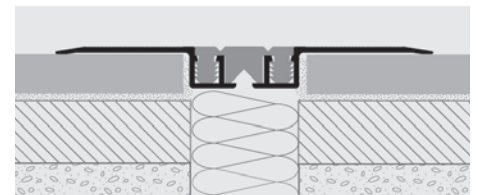

Fix the side wings/flanges in aluminium with:  
1. Screws and screw anchors at 20 cm intervals along both sides of the whole joint  
2. Two-pack epoxy adhesive or with strong fast-setting silicone.

Due to the nature of the product itself, natural aluminium, and its specific use on the floor as technical joint with no decorative role, light scratches on its surface will not be accepted for claims.

### INSERT COLOURS

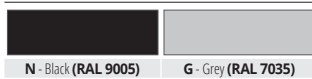

ON DEMAND - MINIMUM QUANTITY 100 lm  
ONLY FOR: PENF 115, PENF 130

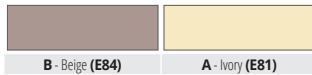

(Price to be agreed. Production delay 4/5 weeks)

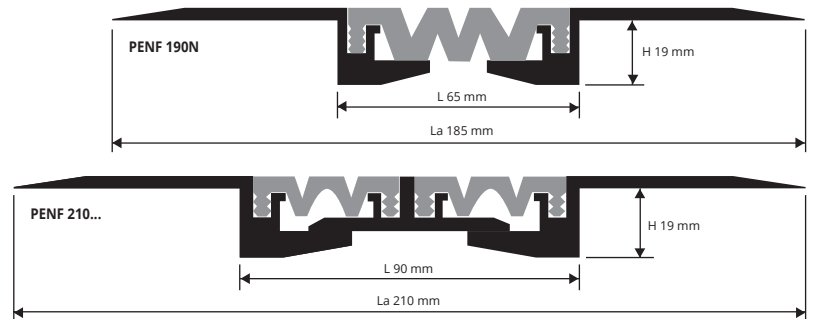

## ANGLES BAR / WALL

NATURAL ALUMINIUM + NEOPRENE INSERT

**ANGLE BAR NATURAL ALUMINIUM + NEOPRENE INSERT**  
bar length 3 lm - pack. 10 Pcs - 30 lm

Article	LxHxLa mm
PENFP 190N	65 x 19 x 125
PENFP 210..	90 x 19 x 150

**INTERCHANGEABLE BLACK OR GREY VINYL RESIN/RUBBER INSERT**  
bar length 3 lm - pack. 10 Pcs - 30 lm

Article	L mm
IPEN 65N	65
IPEN 452...	45 x 2 Pz

Available in the colours: G - N.  
The code of the selected finish must be added to the article code.  
E.g.: PENFP 210... (chosen insert colour grey) PENFP 210G.

### PRODUCT SUPPLIED NOT ASSEMBLED

Due to the nature of the product itself, natural aluminium, and its specific use on the floor as technical joint with no decorative role, light scratches on its surface will not be accepted for claims.

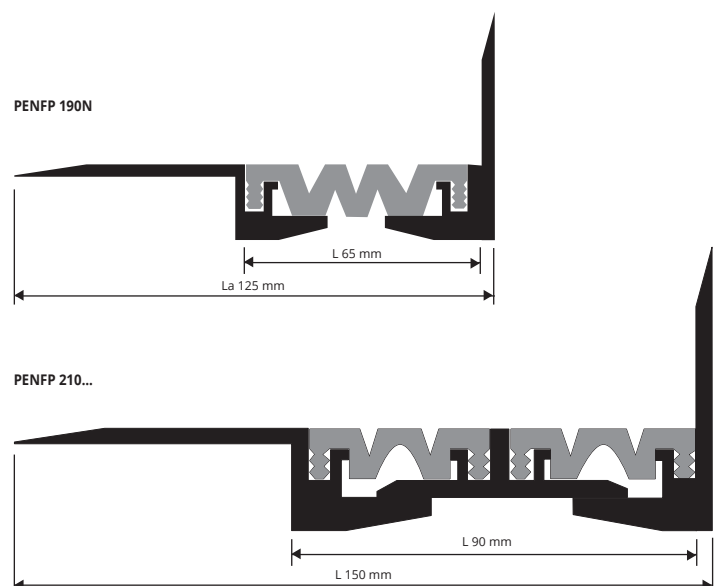

\* = Production on demand with minimum quantity of 100 pcs. Production delay 4/5 weeks. Price to be agreed

# PROEXPAN H20 PROEXPAN H40

NATURAL ALUMINIUM  
+ VINYL RESIN / RUBBER INSERT

**PROEXPAN H20 - H40** is a range of professional structural joints for floors laid on mortar bed (PEN H20) and (PEN H 40). They are made with a punched aluminium base and a vinyl rubber insert available in black or grey. **PROEXPAN H20 - H40** profiles for laying with mortar must have the flanges fixed to the substrate by screws and screw anchors (approx. every 30 cm).

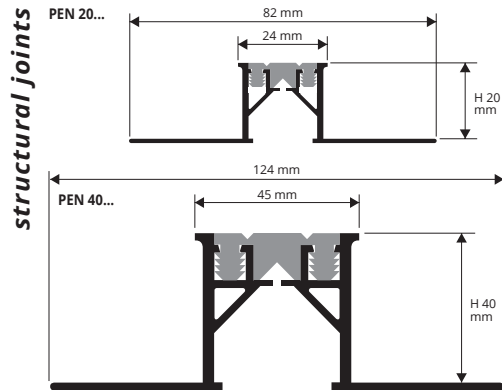

**NATURAL ALUMINIUM + VINYL RESIN / RUBBER INSERT**  
bar length 3 lm - pack. 5 Pcs - 15 lm

Article	HxL mm		
PEN 20...	20 x 24		
PEN 40...	40 x 45		

**INTERCHANGEABLE INSERT IN VINYL RESIN/RUBBER INSERT**  
**BLACK OR GREY** - bar length 3 lm - pack. 10 Pcs - 30 lm

Article	L mm		
IPEN 20...	20		
IPEN 40...	35		

## EXAMPLES AND INSTRUCTIONS FOR LAYING METHODS

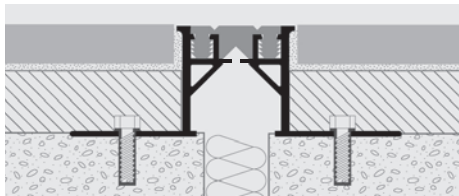

1. Choose the expansion joint with suitable height for the thickness of the floor and the screed/floor rough and choose the colour of the insert. 2. Fix the punched flanges to the substrate using screws and screw anchors, calculating the fixing points at 30cm intervals on both sides. 3. Make the screed over the punched flanges of the structural or expansion joint, calculating the thickness of the final floor, and then lay the floor as normal.

**NATURAL ALUMINIUM ANGLE BAR / WALL + VINYL RESIN / RUBBER INSERT** - bar length 3 lm - pack. 5 Pcs - 15 lm

Article	HxL mm		
PENP 20...	20 x 24		
PENP 40...	40 x 45		

Available in the colours: G - N (Beige and Ivory available on demand with a minimum quantity order of 300 lm). The code of the selected finish must be added to the article code. E.g.: PEN 20... (chosen insert colour grey) PEN 20G.

## INSERT COLOURS



**ON DEMAND - MINIMUM QUANTITY 100 PCS**  
(Price to be agreed. Production delay 4/5 weeks)

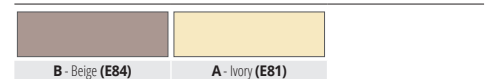

# GDA 25 GDA 35

NATURAL ALUMINIUM  
+ NEOPRENE INSERT

**GDA 25 - GDA 35** is a range of professional structural joints for floors laid on mortar bed. They are made with a punched aluminium base and a vinyl rubber insert available in black or grey. It withstands traffic of vehicles with tyreload to 700 kgs and also trucks with maximum tyreload to 1000 kgs.

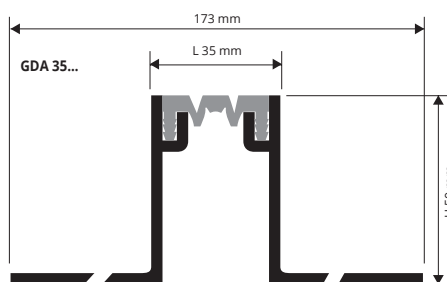
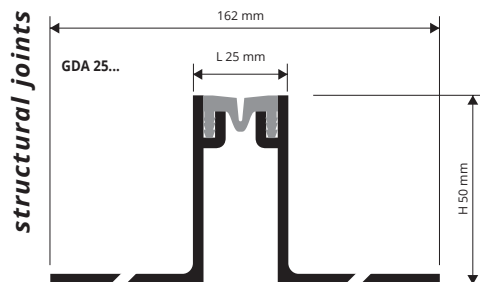

1. Choose the colour of the joint. 2. Fix the punched flanges to the substrate using screws and screw anchors, calculating the fixing points at 30cm intervals on both sides. 3. Make the screed over the punched flanges of the structural or expansion joint, calculating the thickness of the final floor, and then lay the floor as normal. 4. Using the special glue, fill the gap between the tiles and the profile.

## INSERT COLOURS

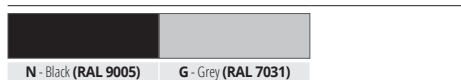

## ON DEMAND

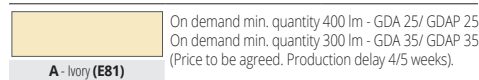

**NATURAL ALUMINIUM + NEOPRENE INSERT**  
bar length 3 lm

Article	HxL mm		
GDA 25...	50 x 25		
GDA 35...	50 x 35		

Movement mm: +/- 5.  
Insert in smooth neoprene on demand.

**NATURAL ALUMINIUM ANGLE BAR / WALL + NEOPRENE INSERT**  
bar length 3 lm

Article	HxL mm		
GDAP 25...	50 x 25		
GDAP 35...	50 x 35		

Available in the colours: G - N (Ivory on demand). The code of the selected finish must be added to the article code. E.g.: GDA 25... (chosen insert colour grey) GDA 25G.

Insert in smooth neoprene on demand.

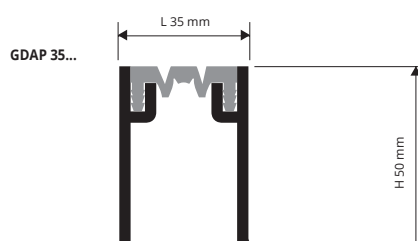
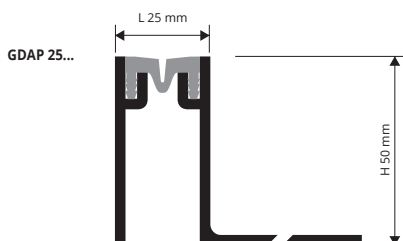

\* = Production on demand with minimum quantity of 100 pcs. Production delay 4/5 weeks. Price to be agreed

**GDA 55** is a structural joint for floors, 35, 50 and 80 mm, in good quality natural aluminium with the interchangeable neoprene insert allowing the joint to expand and contract. Visible thickness 55 mm (**GDA 55**), bar length 3 lm. Black or Grey insert. Bear weights of cars, with the wheel loads up to 650 kg and trucks with a maximum load of 1000 kg on the wheel.

# GDA 55

ALUMINIUM  
+ NEOPRENE INSERT

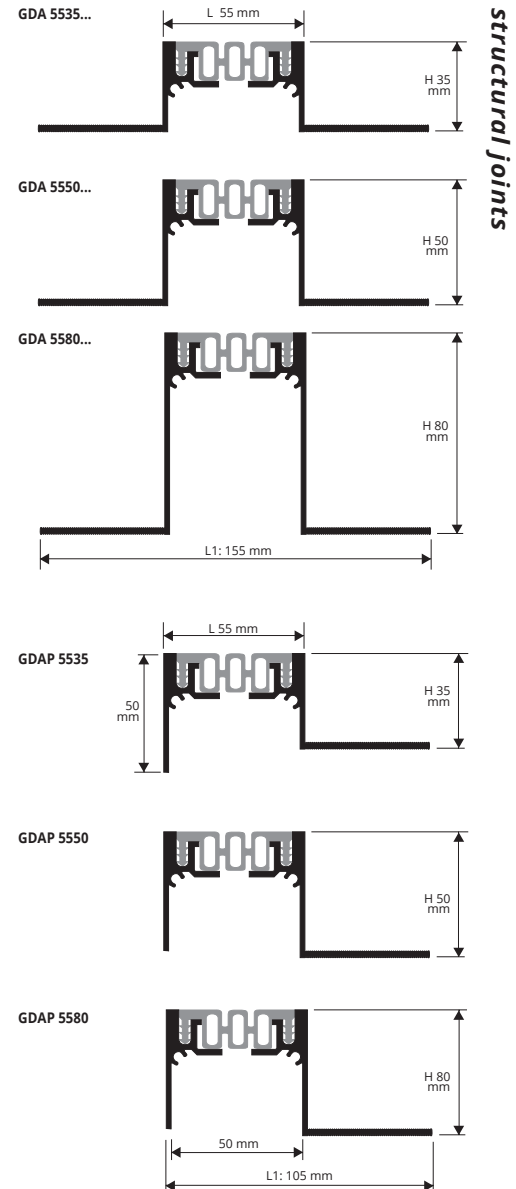
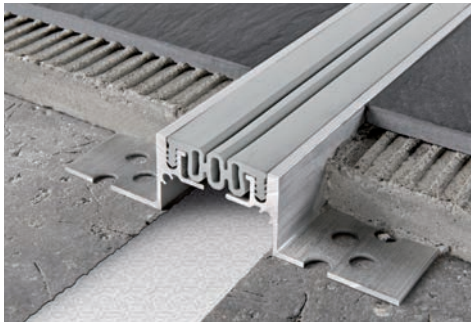

**ALUMINIUM + BLACK / GREY NEOPRENE INSERT**  
bar length 3 lm

Article	L x H x L1 mm
GDA 5535...	55 x 35 x 155
GDA 5550...	55 x 50 x 155
GDA 5580...	55 x 80 x 155

Movement mm: +/- 10

Available in the colours: N - G.

The code of the selected finish must be added to the article code.  
E.g.: GDA 5535...(chosen insert colour black) GDA 5535N

Insert in smooth neoprene on demand.

**ANGLES BAR ALUMINIUM + BLACK NEOPRENE INSERT**  
bar length 3 lm

Article	L x H x L1 mm
GDAP 5535	55 x 35 x 105
GDAP 5550	55 x 50 x 105
GDAP 5580	55 x 80 x 105

Insert in smooth neoprene on demand.

**COLOURS**

N - Black (RAL 9005)	G - Grey (7038)

**EXAMPLES AND INSTRUCTIONS FOR LAYING METHODS**

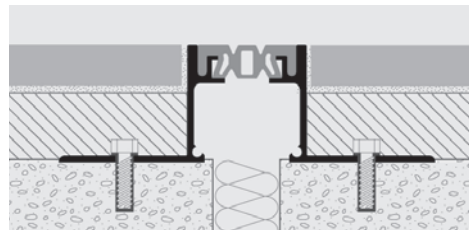

1. Choose the expansion joint with suitable height for the thickness of the floor and the screed/floor rough and choose the colour of the insert.
2. Fix the punched flanges to the substrate using screws and screw anchors, calculating the fixing points at 30 cm intervals on both sides.
3. Make the screed over the punched flanges of the structural or expansion joint, calculating the thickness of the final floor, and then lay the floor as normal.

## FIREPROOF CORD

MINERAL WOOL AND FIBREGLASS

**FIREPROOF GLUE FOR CORD FIXING**

Article	Pack. Kg
CIC 014	1,4
CIC 7	7

The delivery of the test certificate depends on the use of silicate glue for the fixing of the same.  
The cord is certified in accordance with the new European Standard EN 13501-2.  
Consumption of sealant is of about 50 g per linear metre of cord.

**FIREPROOF CORD - Diameter 20 - 60 mm**

Article	Ø mm	lm Roll
CDT 20	20	30
CDT 30	30	30
CDT 40	40	30
CDT 50	50	25
CDT 60	60	25



\* = Production on demand with minimum quantity of 100 pcs. Production delay 4/5 weeks. Price to be agreed

# GNS 20 GNS 50

NATURAL ALUMINIUM

Structural joint **GNS 20 – GNS 50** is in good quality natural aluminium with neoprene in the lower central part and another aluminium profile in the upper visible part. It withstands heavy loads and frequent traffic of vehicles with a total truckload of 8 kgs/mm. Bar length 3 m, visible head width 30 mm.

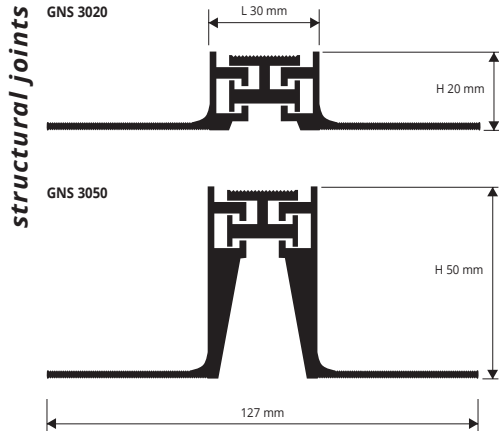

**NATURAL ALUMINIUM**  
bar length 3 lm

Article	L x H mm
GNS 3020	30 x 20
GNS 3050	30 x 50

Movement mm: +/- 3

## EXAMPLES AND INSTRUCTIONS FOR LAYING METHODS

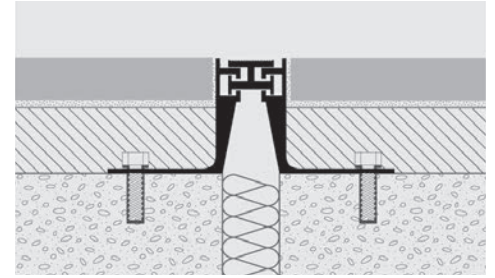

1. Choose the expansion joint with suitable height for the thickness of the floor and the screed/floor rough and choose the colour of the insert. 2. Fix the punched flanges to the substrate using screws and screw anchors, calculating the fixing points at 30cm intervals on both sides. 3. Make the screed over the punched flanges of the structural or expansion joint, calculating the thickness of the final floor, and then lay the floor as normal.

# ANGLES BAR / WALL

NATURAL ALUMINIUM

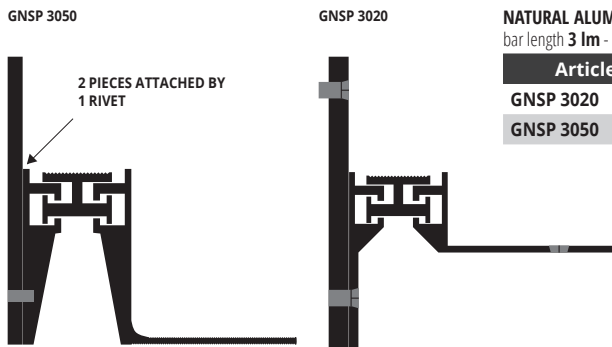

**NATURAL ALUMINIUM ANGLES BAR**  
bar length 3 lm - pack. 10 Pcs - 30 lm

Article	L x H mm
GNSP 3020	30 x 20
GNSP 3050	30 x 50

## COLOURS



# GNS 75... 18/50/80

NATURAL ALUMINIUM

Structural joint **GNS 75** is in good quality natural aluminium with neoprene in the lower central part and another aluminium profile in the upper visible part. It withstands heavy loads and frequent pedestrian traffic. Bar length 3 m, visible head width 75 mm. It withstands forklift trucks with rubber tyre and transpallets to a maximum total load of 6,5 kgs/mm.

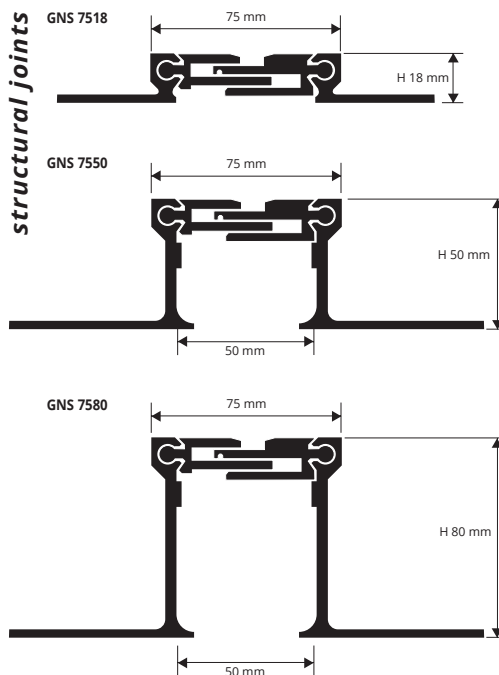

**NATURAL ALUMINIUM**  
bar length 3 lm

Article	H mm
GNS 7518	18
GNS 7550	50
GNS 7580	80

Movement mm: +10/-5 Horiz. +/-5 Vert.

## EXAMPLES AND INSTRUCTIONS FOR LAYING METHODS

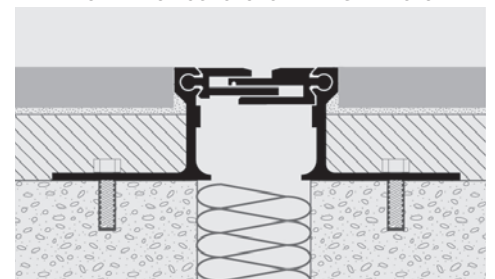

1. Choose the expansion joint with suitable height for the thickness of the floor and the screed/floor rough and choose the colour of the insert. 2. Fix the punched flanges to the substrate using screws and screw anchors, calculating the fixing points at 30cm intervals on both sides. 3. Make the screed over the punched flanges of the structural or expansion joint, calculating the thickness of the final floor, and then lay the floor as normal.

## COLOURS



\* = Production on demand with minimum quantity of 100 pcs. Production delay 4/5 weeks. Price to be agreed

**PROPLATE FIX** is a range of flat joint-cover profiles to cover structural movements (contraction due to flexural or compressive stress) of two different load-bearing structures.

**PROPLATE FIX** made in silver anodized aluminium is recommended for environments with intense pedestrian and vehicular traffic. Available upon request with stainless steel fixing clips (5 Pcs. for vertical/façade use 10 Pcs. for horizontal/floor use); corner profiles are also available.

# PROPLATE FIX

FLAT AND ANGLE PROFILE IN ALUMINIUM

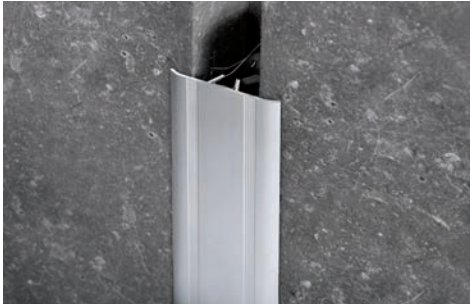

**FLAT PROFILE - SILVER ANOD. ALUMINIUM**  
bar length 2,7 lm - pack. 20 Pcs - 54 lm

Article	L mm
PETFXPAA 50	50
PETFXPAA 70	70



**ANGLE PROFILE - SILVER ANOD. ALUMINIUM**  
bar length 2,7 lm - pack. 20 Pcs - 54 lm

Article	H x L mm
PETFXAA 50	22 x 50
PETFXAA 70	24 x 70

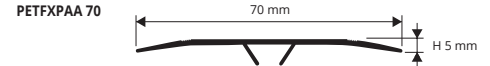

PETFXAA 50

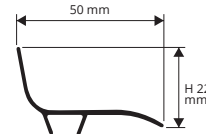

PETFXAA 70

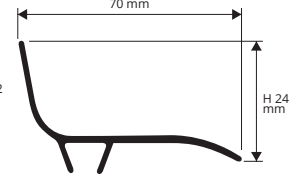

PRODUCT SUPPLIED NOT ASSEMBLED

Article	H mm
CPFXAC 40/10	40

**COLOURS**



AA - Anodized silver alum.

**EXAMPLES AND INSTRUCTIONS FOR LAYING METHODS**

1. Choose the profile in the required width and material. 2. Insert the fixing clips into the relative groove, one every 50/75 cm (5 Pcs. for wall applications - 10 Pcs. for floor applications). 3. Insert/Lay the PROPLATE FIX in the existing void, applying uniform pressure or using a plastic hammer, thereby creating a perfect joint cover. The same method is used for laying the corner profile.

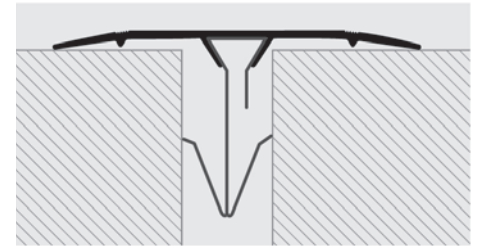

**PROPLATE FIX** is a range of flat joint-cover profiles to cover structural movements (contraction due to flexural or compressive stress) of two different load-bearing structures.

**PROPLATE FIX** made in rigid PVC is recommended for walls and facades and for ceilings. Available upon request with stainless steel fixing clips (5 Pcs. for vertical/façade use 10 Pcs. for horizontal/floor use); corner profiles are also available.

# PROPLATE FIX

FLAT AND ANGLE PROFILE IN VINYL RESIN (PVC)



**FLAT PROFILE - VINYL RESIN (PVC)**  
bar length 2,7 lm - pack. 20 Pcs - 54 lm

Article	L mm
PETFXP 50-01	50



**ANGLE PROFILE - VINYL RESIN (PVC)**  
bar length 2,7 lm - pack. 20 Pcs - 54 lm

Article	H x L mm
PETFX 50-01	22 x 50

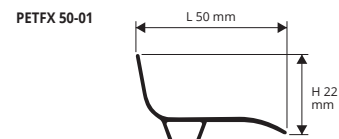

PRODUCT SUPPLIED NOT ASSEMBLED

**FIXING CLIPS BETWEEN 20 TO 45 mm - STAINLESS STEEL - pack. 10 Pcs**

Article	H mm
CPFXAC 40/...	40

**COLOURS**

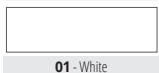

01 - White

CPFXAC 40

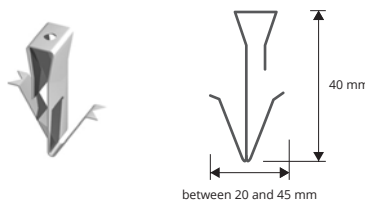

**EXAMPLES AND INSTRUCTIONS FOR LAYING METHODS**

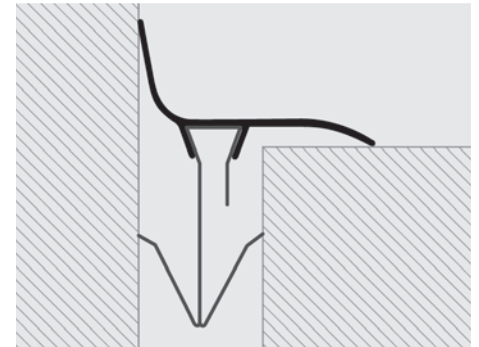

1. Choose the profile in the required width and material. 2. Insert the fixing clips into the relative groove (5 Pcs. for wall applications - 10 Pcs. for floor applications). 3. Insert/Lay the PROPLATE FIX in the existing void, applying uniform pressure or using a plastic hammer, thereby creating a perfect joint cover. The same method is used for laying the corner profile.

\* = Production on demand with minimum quantity of 100 pcs. Production delay 4/5 weeks. Price to be agreed

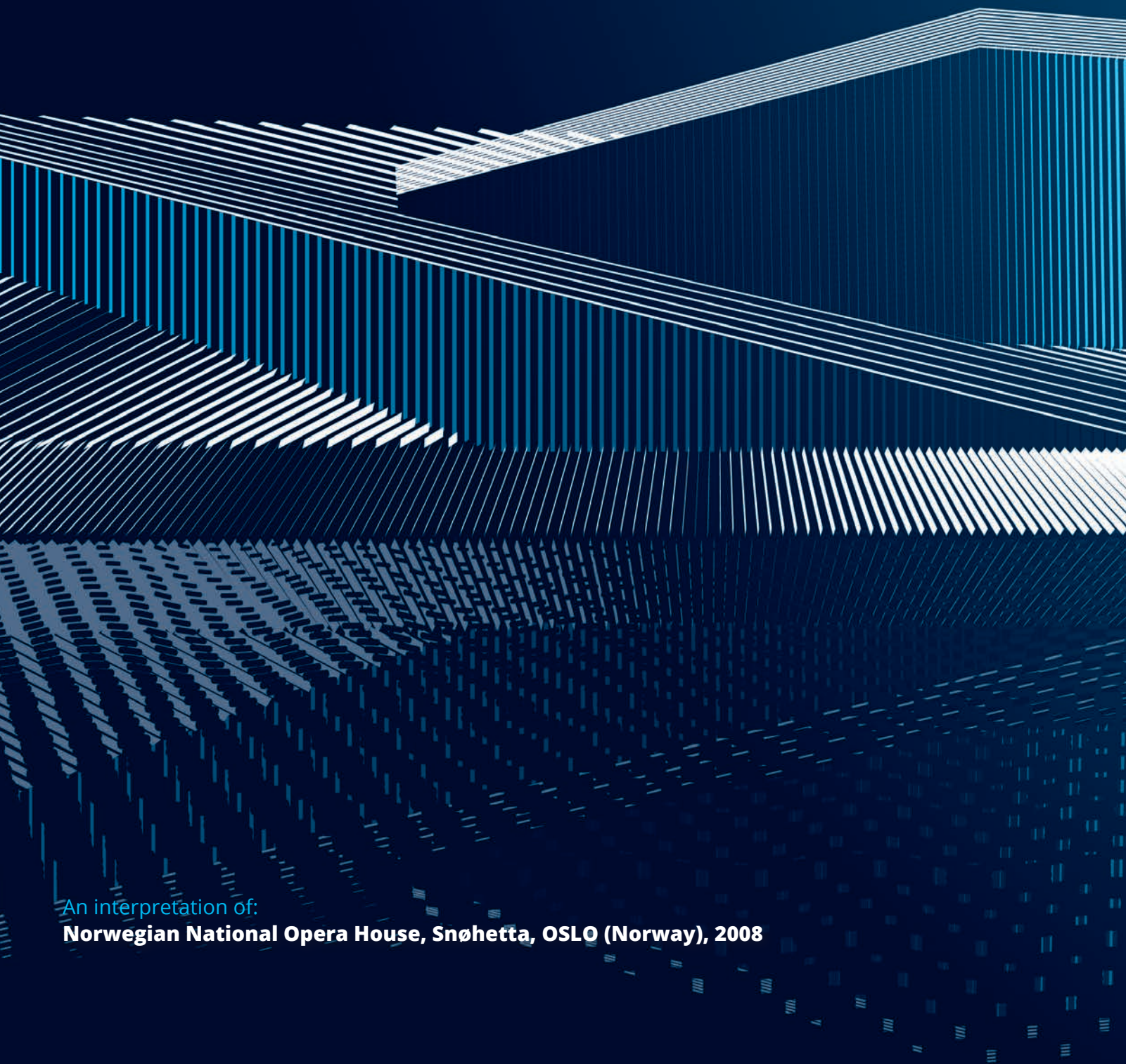

An interpretation of:  
**Norwegian National Opera House, Snøhetta, OSLO (Norway), 2008**



PROFILES & SYSTEMS

LOW THICKNESS

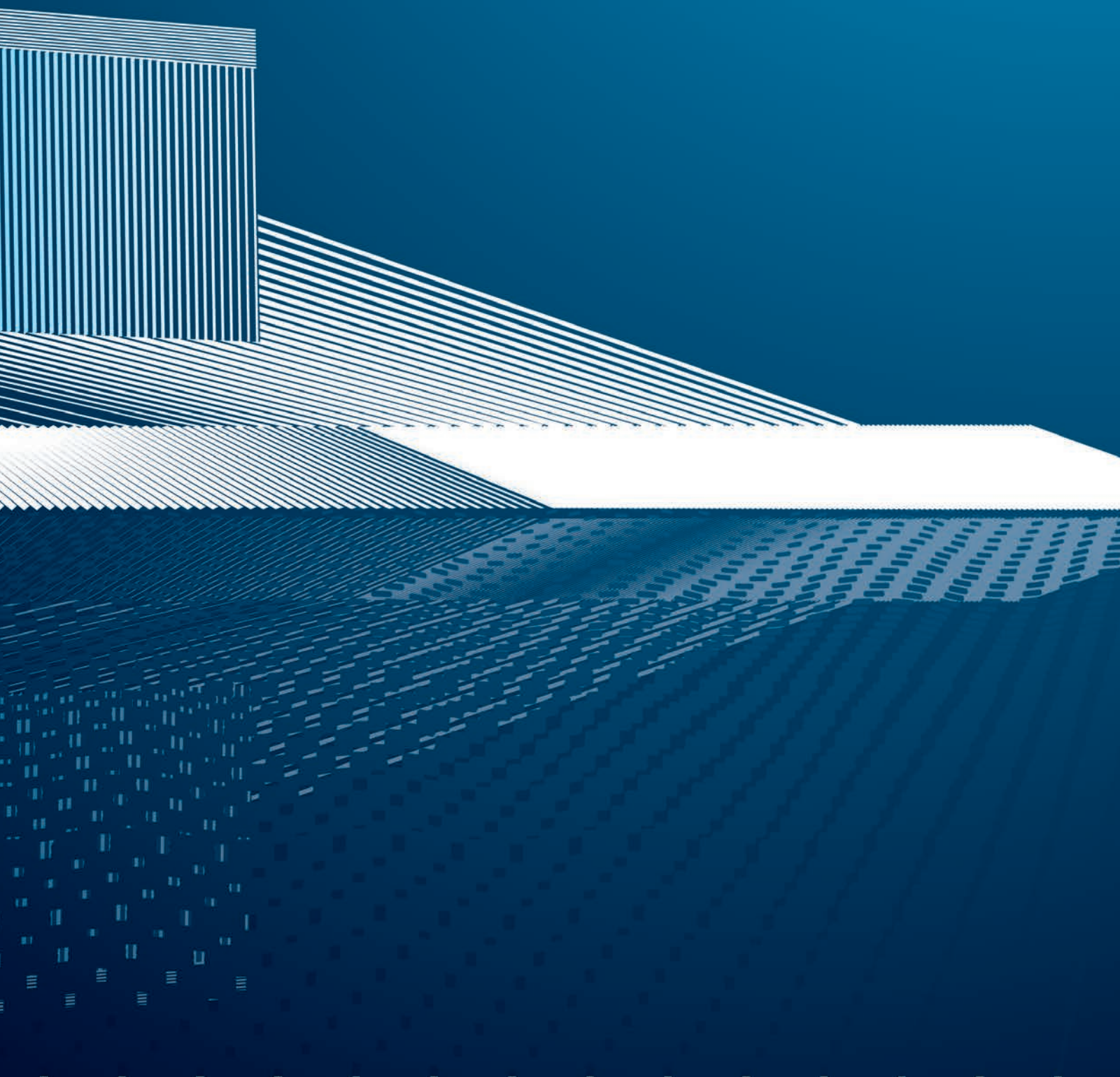



# PROKERLAM SQUARE

ANODIZED SILVER, POLISHED CHROME AND GOLD ALUMINIUM

**PROKERLAM SQUARE** is a square corner bead profile in anodized and polished aluminium suitable to protect the external corners of coverings with low thickness. It can be used like connection profile between step tread and riser of stairs coated with ceramic and mosaic with low thickness. Its particular section and the availability in three different finishes make **PROKERLAM SQUARE** a much sought-after profile that allows a workmanlike application even with low thickness coverings.

PKLQ... 045  
scale 1:1

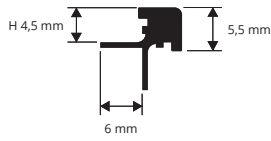

## EXAMPLES AND INSTRUCTIONS FOR LAYING METHODS



1. Choose "PROKERLAM SQUARE" according to the desired finish.
2. Cut "PROKERLAM SQUARE" to the desired length and apply the adhesive on the support where the profile will be laid.
3. Press the anchoring flange of "PROKERLAM SQUARE" into the adhesive.
4. Lay the tiles, aligning them with the profile leaving a 2 mm joint. Remove immediately all remains of adhesive from the surface of the profile.
5. Fill the joints between the profile and the tiles with grout, in order to avoid water stagnation. Remove immediately all the remains of grout from the surface of the profile.



**ANODIZED SILVER ALUMINIUM thermo packed**  
bar length 2,7 lm - pack. 40 Pcs - 108 lm

Article	H mm	€/lm	€/Pc
PKLQAA 045	4,5		



**POLISHED GOLD ALUMINIUM thermo packed**  
bar length 2,7 lm - pack. 40 Pcs - 108 lm

Article	H mm	€/lm	€/Pc
PKLQBO 045	4,5		

**POLISHED CHROME ALUMINIUM thermo packed**  
bar length 2,7 lm - pack. 40 Pcs - 108 lm

Article	H mm	€/lm	€/Pc
PKLQBC 045	4,5		

## COLOURS



# PROKERLAM JOLLY

ANODIZED AND POLISHED ALUMINIUM SILVER, CHROME AND GOLD

**PROKERLAM JOLLY** is a quarter-circle rounded bead profile in anodized and polished aluminium suitable to protect the external corners of coverings with low thickness. It can be used like connection profile between step tread and riser of stairs coated with ceramic and mosaic with low thickness. Its particular section and the availability in three different finishes make **PROKERLAM JOLLY** a much sought-after profile that allows a workmanlike application even with low thickness coverings.

PKLJ... 045  
scale 1:1

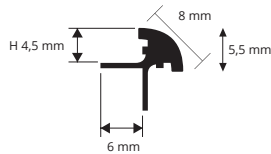

## EXAMPLE FOR LAYING



1. Choose "PROKERLAM Jolly" according to the desired finish.
2. Cut "PROKERLAM Jolly" to the desired length and apply the adhesive on the support where the profile will be laid.
3. Press the anchoring flange of "PROKERLAM Jolly" into the adhesive.
4. Lay the tiles, aligning them with the profile leaving a 2 mm joint. Remove immediately all remains of adhesive from the surface of the profile.
5. Fill the joints between the profile and the tiles with grout, in order to avoid water stagnation. Remove immediately all the remains of grout from the surface of the profile.



**ANODIZED SILVER ALUMINIUM thermo packed**  
bar length 2,7 lm - pack. 40 Pcs - 108 lm

Article	H mm	€/lm	€/Pc
PKLJAA 045	4,5		



**POLISHED CHROME ALUMINIUM thermo packed**  
bar length 2,7 lm - pack. 40 Pcs - 108 lm

Article	H mm	€/lm	€/Pc
PKLJBC 045	4,5		

## COLOURS



**POLISHED GOLD ALUMINIUM thermo packed**  
bar length 2,7 lm - pack. 40 Pcs - 108 lm

Article	H mm	€/lm	€/Pc
PKLJBO 045	4,5		

\* = Production on demand with minimum quantity of 100 pcs. Production delay 4/5 weeks. Price to be agreed

Prices are referred to whole packs, 10% increase for minimum orders of 10 pcs, 20% increase for orders of less than 10 pcs.





**PROKERLAM LINE** is a profile in polished and brushed stainless steel AISI 304/1.4301-V2A suitable to protect the external corners of coverings in low thickness. It can be used like connection profile between step tread and riser of stairs coated with ceramic and mosaic with low thickness. Its particular section and the availability in three different heights and finishes and special pieces such as internal and external corners, end caps and joints make **PROKERLAM LINE** a much sought-after profile that allows a workmanlike application even with low thickness coverings.

# PROKERLAM LINE

POLISHED AND BRUSHED STAINLESS STEEL AISI 304/1.4301-V2A



**POLISHED STAINLESS ST. AISI 304/1.4301-V2A with protective film**  
Bar lenght 2,7 lm - Pack 40 PCS - 108 lm

Article	H mm	€/lm	€/Pcs
PKLLAC 045	4,5		
PKLLAC 06	6		



**BRUSHED STAINLESS ST. AISI 304/1.4301-V2A with protective film**  
Bar lenght 2,7 lm - Pack 40 PCS - 108 lm

Article	H mm	€/lm	€/Pcs
PKLLACS 045	4,5		
PKLLACS 06	6		

### COLOURS



AC - Polished stainless steel AISI 304/1.4301-V2A ACS - Brushed stainless steel AISI 304/1.4301-V2A



### LAYING INSTRUCTIONS



1. Choose "PROKERLAM LINE" according to the desired finish.
2. Cut "PROKERLAM LINE" to the desired length and apply the adhesive on the support where the profile will be laid.
3. Press the anchoring flange of "PROKERLAM LINE" into the adhesive.
4. Lay the tiles, aligning them with the profile leaving a 2 mm joint. Remove immediately all remains of adhesive from the surface of the profile.
5. Fill the joints between the profile and the tiles with grout, in order to avoid water stagnation. Remove immediately all the remains of grout from the surface of the profile.

**PROKERLAM LINE** is a Y-shaped profile in anodized and polished aluminium suitable to protect the external corners of coverings in low thickness. It can be used like connection profile between step tread and riser of stairs coated with ceramic and mosaic with low thickness. Its particular section and the availability in three different heights and finishes and special pieces such as internal and external corners, end caps and joints make **PROKERLAM LINE** a much sought-after profile that allows a workmanlike application even with low thickness coverings.

# PROKERLAM LINE

ANODIZED, VARNISHED AND STONE LINE ALUMINIUM



**ANODISED SILVER ALUMINIUM thermo packed**  
Bar lenght 2,7 lm - Pack 40 PCS - 108 lm

Article	H mm	€/lm	€/Pcs
PKLLAA 045	4,5		
PKLLAA 06	6		

**VARNISHED ALUMINIUM (White-Black) thermo packed**  
Bar lenght 2,7 lm - Pack 40 PCS - 108 lm

Article	H mm	€/lm	€/Pcs
PKLLA 045-01	4,5		
PKLLA 045-11	4,5		
PKLLA 06-01	6		
PKLLA 06-11	6		



**STONE LINE ALUMINIUM thermo packed**  
Bar lenght 2,7 lm - Pack 40 PCS - 108 lm

Article	H mm	€/lm	€/Pcs
PKLLA 045-SL...	4,5		
PKLLA 06-SL...	6		

The code of the selected colour must be added to the article code.  
E.g.: PKLLA 06-... (chosen colour stone cream) PKLLA 06-SL02.

### COLOURS

ANODIZED	VARNISHED	
AA - Anodized Silver Alu.	01 - White Varnished Alu.	11 - Black Varnished Alu.

STONE LINE		
SL02 - Stone cream	SL03 - Stone greywoy	SL04 - Stone sand
SL05 - Stone grey	SL08 - Stone antradark	



### LAYING INSTRUCTIONS



1. Choose "PROKERLAM LINE" according to the desired finish.
2. Cut "PROKERLAM LINE" to the desired length and apply the adhesive on the support where the profile will be laid.
3. Press the anchoring flange of "PROKERLAM LINE" into the adhesive.
4. Lay the tiles, aligning them with the profile leaving a 2 mm joint. Remove immediately all remains of adhesive from the surface of the profile.
5. Fill the joints between the profile and the tiles with grout, in order to avoid water stagnation. Remove immediately all the remains of grout from the surface of the profile.



**PROSHELL D ALL** is a profile in anodized and polished aluminum with a visible 45° sloping surface. The profile allows to connect the floor and wall coverings in ceramic and mosaic with low thickness. It is particularly suitable to ensure cleanliness and hygiene in every kind of environment where good resistance to mechanical and chemical stresses are required. Its particular section and availability in three different finishes, make **PROSHELL D ALL** a much sought after profile.

## PROSHELL D ALL

ANODIZED SILVER, POLISHED CHROME AND GOLD ALUMINIUM



PSHD... 045  
scale 1:1

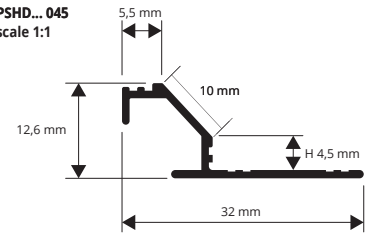

**ANODIZED SILVER ALUMINIUM thermo packed**  
bar length 2,7 lm - pack. 40 Pcs - 108 lm

Article	H mm	€/lm	€/Pc
PSHDAA 045	4,5		

**POLISHED CHROME/GOLD ALUMINIUM thermo packed**  
bar length 2,7 lm - pack. 40 Pcs - 108 lm

Article	H mm	€/lm	€/Pc
PSHDBC 045	4,5		
PSHDBO 045	4,5		

### EXAMPLES AND INSTRUCTIONS FOR LAYING METHODS

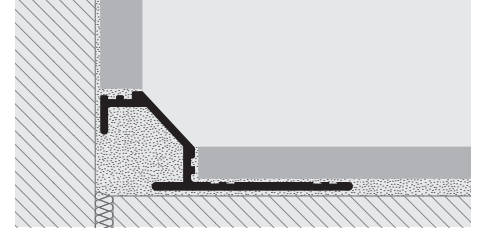

1. Choose "PROSHELL D ALL" according to the desired finish.
2. Cut "PROSHELL D ALL" to the desired length and apply the adhesive on the support where the profile will be laid.
3. Press the anchoring flange of "PROSHELL D ALL" into the adhesive.
4. Lay the tiles, aligning them with the profile leaving a 2 mm joint. Remove immediately all remains of adhesive from the surface of the profile.
5. Fill the joints between the profile and the tiles with grout, in order to avoid water stagnation. Remove immediately all the remains of grout from the surface of the profile.

### COLOURS

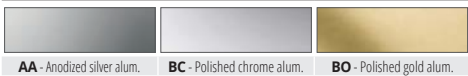

**PROSHELL R ALL** is a cove-shaped profile in anodized and polished aluminum. The profile allows to connect the floor and wall coverings in ceramic and mosaic with low thickness. It is particularly suitable to ensure cleanliness and hygiene in every kind of environment where good resistance to mechanical and chemical stresses are required. Its particular section and availability in three different finishes, make **PROSHELL R ALL** a much sought after profile.

## PROSHELL R ALL

ANODIZED SILVER, POLISHED CHROME AND GOLD ALUMINIUM



**ANODIZED SILVER ALUMINIUM thermo packed**  
bar length 2,7 lm - pack. 40 Pcs - 108 lm

Article	H mm	€/lm	€/Pc
PSHRAA 045	4,5		

**POLISHED CHROME/GOLD ALUMINIUM thermo packed**  
bar length 2,7 lm - pack. 40 Pcs - 108 lm

Article	H mm	€/lm	€/Pc
PSHRBC 045	4,5		
PSHRBO 045	4,5		

### COLOURS



PSHR... 045  
scale 1:1

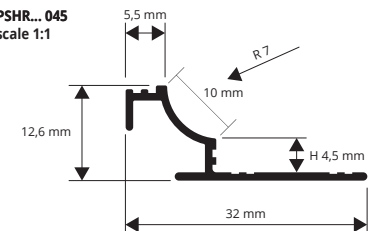

### EXAMPLES AND INSTRUCTIONS FOR LAYING METHODS

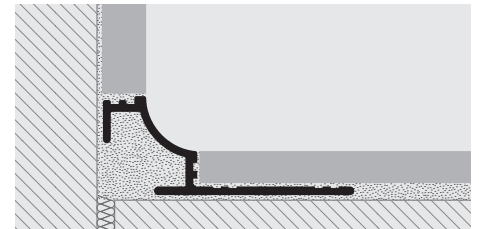

1. Choose "PROSHELL R ALL" according to the desired finish.
2. Cut "PROSHELL R ALL" to the desired length and apply the adhesive on the support where the profile will be laid.
3. Press the anchoring flange of "PROSHELL R ALL" into the adhesive.
4. Lay the tiles, aligning them with the profile leaving a 2 mm joint. Remove immediately all remains of adhesive from the surface of the profile.
5. Fill the joints between the profile and the tiles with grout, in order to avoid water stagnation. Remove immediately all the remains of grout from the surface of the profile.

\* = Production on demand with minimum quantity of 100 pcs. Production delay 4/5 weeks. Price to be agreed

Prices are referred to whole packs, 10% increase for minimum orders of 10 pcs, 20% increase for orders of less than 10 pcs.



# PROINTER KL ACC

STAINLESS STEEL AISI 304/1.4301-V2A

**PROINTER KL ACC** is a cove-shaped profile in stainless steel AISI 304/1.4301-V2A. The profile allows to connect the floor and wall coverings in ceramic and mosaic also with low thickness. It is particularly suitable to ensure cleanliness and hygiene in every kind of environment where good resistance to mechanical and chemical stresses are required. Its particular section makes **PROSHELL KL ALL** a much sought after profile.

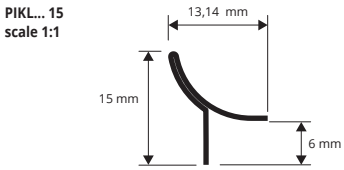

## EXAMPLES AND INSTRUCTIONS FOR LAYING METHODS

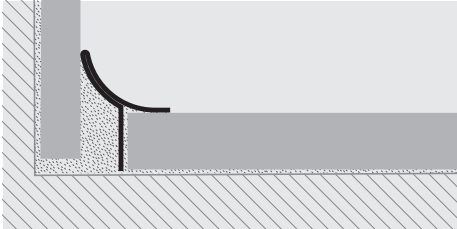

1. Choose "PROINTER KL ACC" according to the desired finish. 2. Cut "PROINTER KL ACC" to the desired length. 3. Apply the silicone along the floor-wall connection. 4. Press the arrowhead of "PROINTER KL ACC" into the silicone evenly until it is completely adherent to the floor and wall.

SUITABLE FOR USE IN CONTACT WITH FOODSTUFFS



**POLISHED STAINLESS ST. AISI 304/1.4301-V2A with protective film**  
bar length 2,7 lm - pack. 40 Pcs - 108 lm - 8/10mm

Article	H mm	€/lm	€/Pc
PIKLAC 15	15		

**BRUSHED STAINLESS ST. AISI 304/1.4301-V2A with protective film**  
bar length 2,7 lm - pack. 40 Pcs - 108 lm - 8/10mm

Article	H mm	€/lm	€/Pc
PIKLACS 15	15		

## COLOURS

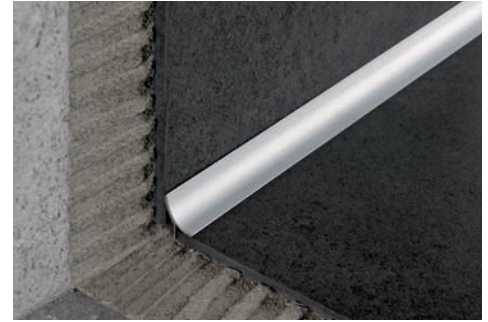

**SANDED STAINLESS ST. AISI 304/1.4301-V2A with protective film**  
bar length 2,7 lm - pack. 40 Pcs - 108 lm - 8/10mm

Article	H mm	€/lm	€/Pc
PIKLACSB 15	15		

**SUPER POLISHED ST. AISI 304/1.4301-V2A with protective film**  
bar length 2,7 lm - pack. 40 Pcs - 108 lm - 8/10mm

Article	H mm	€/lm	€/Pc
PIKLACML 15	15		

## AVAILABLE MINIMUM QUANTITY 100 PCS



# PROINTER KL ALL

POLISHED AND CHROMED BRASS AND ANODIZED AND POLISHED ALUMINIUM

**PROSHELL KL ALL** is a cove-shaped profile in polished and chromed brass and anodized and polished aluminium. The profile allows to connect the floor and wall coverings in ceramic and mosaic also with low thickness. It is particularly suitable to ensure cleanliness and hygiene in every kind of environment where good resistance to mechanical and chemical stresses are required. Its particular section and availability in five different finishes, make **PROSHELL KL ALL** a much sought after profile.

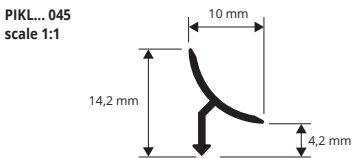

## EXAMPLES AND INSTRUCTIONS FOR LAYING METHODS

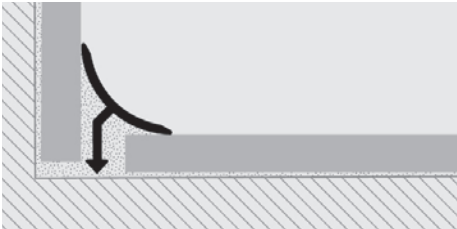

1. Choose "PROINTER KL ALL" according to the desired finish. 2. Cut "PROINTER KL ALL" to the desired length. 3. Apply the silicone along the floor-wall connection. 4. Press the arrowhead of "PROINTER KL ALL" into the silicone evenly until it is completely adherent to the floor and wall.



**POLISHED / CHROMED BRASS thermo packed**  
bar length 2,7 lm - pack. 40 Pcs - 108 lm

Article	H mm	€/lm	€/Pc
PIKLLOL 045	4,5		
PIKLOC 045	4,5		

## CAPS - VARNISHED PLASTIC

Article	€/Pack. 2 Pcs	€/Pack. 10 Pcs
TPIKL .../...		



\* End caps of the on demand profiles are also on demand.

## COLOURS



**POLISHED CHROME ALUMINIUM / GOLD thermo packed**  
bar length 2,7 lm - pack. 40 Pcs - 108 lm

Article	H mm	€/lm	€/Pc
PIKLBC 045	4,5		
PIKLBO 045	4,5		

**ANODIZED SILVER ALUMINIUM thermo packed**  
bar length 2,7 lm - pack. 40 Pcs - 108 lm

Article	H mm	€/lm	€/Pc
PIKLAA 045	4,5		

## CAPS - VARNISHED PLASTIC

Article	€/Pack. 2 Pcs	€/Pack. 10 Pcs
TPIKL .../...		



## COLOURS



\* = Production on demand with minimum quantity of 100 pcs. Production delay 4/5 weeks. Price to be agreed

Prices are referred to whole packs, 10% increase for minimum orders of 10 pcs, 20% increase for orders of less than 10 pcs.

**PROSTYLE KL 10** is a step protecting profile, technical and very elegant, used to keep the step made of thin ceramic tiles and kerlite/laminam non-skid and non-slip. Product in anodized aluminium with the angle portion crimped in order to increase its adhesion. Internal height 4.5 mm. It is compulsory in public buildings to comply with accident-prevention regulations.

# PROSTYLE KL 10

ANODIZED SILVER ALUMINIUM



**ANODIZED SILVER ALUMINIUM**  
bar length 2,7 lm - pack. 40 Pcs - 108 lm

Article	H mm	€/lm	€/Pc
PSYKLAA 1045	4,5		

### COLOURS



AA - Anodized silver aluminium

**CAPS** - pack. 2 Pcs (1 R and 1 L)

Article	H mm	€/Pack.
TPSYKLAA 1045/1	4,5	

Articles not for sale singly

1. Cut "PROSTYLE KL 10" to the desired length.
2. Lay the tiles on the step rise and apply the adhesive on the step tread where the profile will be laid.
3. Lay the profile on the step tread aligning it with the tiles of the step rise.
4. Apply the adhesive on the step tread and lay the tiles, aligning them with the profile. Remove immediately all the remains of adhesive from the surface of the profile.
5. Grout the joints between the tile and the profile, in order to avoid water stagnation. Remove immediately all the remains of grout from the surface of the profile.

PSYKLAA 1045  
scale 1:1

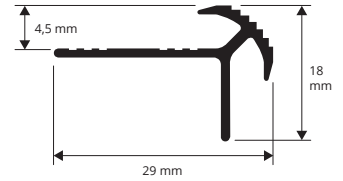

### EXAMPLES AND INSTRUCTIONS FOR LAYING METHODS

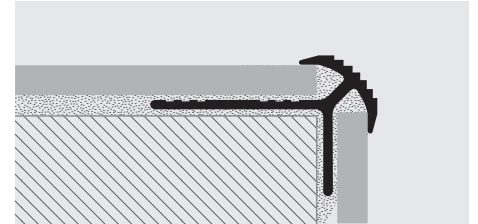

**PROSTAIR KL 20** is a step protecting profile, technical and very elegant, used to keep the step made of thin ceramic tiles and kerlite/laminam non-skid and non-slip. Product in anodized aluminium with the upper portion crimped in order to increase its adhesion and a lower vertical tab created to cover the riser of the step. It is compulsory in public buildings to comply with accident-prevention regulations. Available height H 4.5 mm.

# PROSTAIR KL 20

ANODIZED SILVER ALUMINIUM

**ANODIZED SILVER ALUMINIUM**  
bar length 2,7 lm - pack. 40 Pcs - 108 lm

Article	H mm	€/lm	€/Pc
PTRKLAA 2045	4,5		

### COLOURS



AA - Anodized silver aluminium



1. Cut "PROSTAIR KL 20" to the desired length.
2. Lay the tiles on the step rise and apply the adhesive on the step tread where the profile will be laid.
3. Fill the cavities on back of the profile with adhesive and lay it on the step tread aligning it with the tiles of the step rise.
4. Apply the adhesive on the step tread and lay the tiles, aligning them with the profile. Remove immediately all the remains of adhesive from the surface of the profile.
5. Grout the joints between the tile and the profile, in order to avoid water stagnation. Remove immediately all the remains of grout from the surface of the profile.

PTRKLAA 2045  
scale 1:1

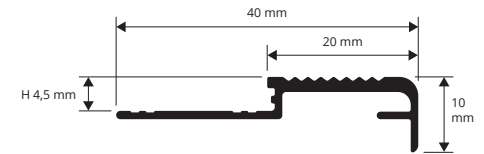

### EXAMPLES AND INSTRUCTIONS FOR LAYING METHODS

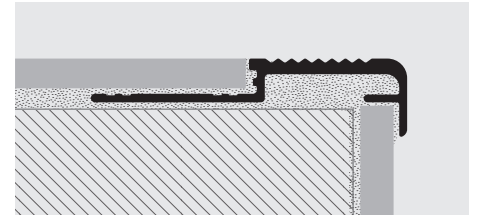



An interpretation of:  
**Petronas Towers, César Pelli, KUALA LUMPUR (Malaysia), 1996**



PROFILES FOR TERRACES





# PROTERRACE DOUBLE DRIP

VARNISHED ALUMINIUM

**PROTERRACE DOUBLE DRIP** is an edging profile in varnished aluminium, designed to protect the edges of the tiles on terraces and balconies and to allow the downflow of water. The profile is provided with a flange that ensures the right fixing and an adhesive stripe, which protect the outflow holes to be closed by silicone. The double drip allows the drainage water to flow out in case of application with PRODES0 DRAIN draining membrane. To reach a right connection between profile and the waterproofing system it's needed to use **PROBAND 150** with **PROBAND KOLL/AB**. The product is also available on request with a **SPECIAL SEASIDE PRE-TREATMENT** which increases its resistance to corrosion when installed at sea front environments.

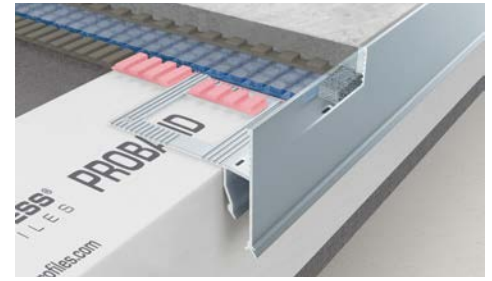
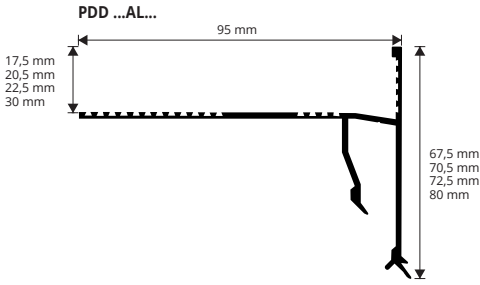

## EXAMPLES AND INSTRUCTIONS FOR LAYING METHODS

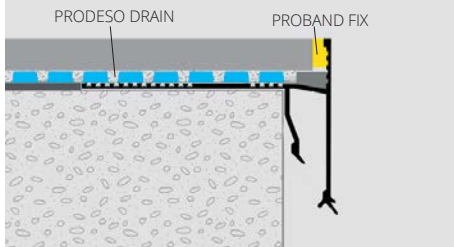

1. Choose PROTERRACE DOUBLE DRIP according to the tile thickness and desired colour.
2. Fix the external corners to the screed (at least 1 cm from it) with nails.
3. Fix the draining adhesive stripe in polyurethane on the vertical side of the profile.
4. Cut the PROTERRACE DOUBLE DRIP at desired length joining it to the corners using the linking elements and fix it with nails to the substrate.
5. Lay the desired waterproofing system.
6. Lay the tiles leaving at 5 mm between the tile and the profile.
7. Seal the space between tile and profile with **PROBAND FIX (PRBFX)**.

## VARNISHED/COATED ALUMINIUM

bar length 2,7 lm - pack. 5 Pcs - 13,5 lm

Article	H mm	€/lm	€/Pc
<input type="checkbox"/> PDD 175AL...	17,5		
<input type="checkbox"/> PDD 205AL...	20,5		
<input type="checkbox"/> PDD 225AL...	22,5		
<input type="checkbox"/> PDD 30AL...	30		

## ARTICLE AVAILABLE FROM APRIL 2022

Available in the colours: BF - GF - A - TF (EF - C - B - G - E - T on demand). The code of the selected colour must be added to the article code. E.g.: PDD 175AL... (white) PDD 175ALBF.

## EXTERNAL CORNERS - pack. 10 Pcs

Article	€/Pc	€/pack
<input type="checkbox"/> AEPDD 175AL.../10		
<input type="checkbox"/> AEPDD 205AL.../10		
<input type="checkbox"/> AEPDD 225AL.../10		
<input type="checkbox"/> AEPDD 30AL.../10		

## JOINTS - pack. 1

Article	€/Pc
<input type="checkbox"/> GINPDD 175AL...	
<input type="checkbox"/> GINPDD 205AL...	
<input type="checkbox"/> GINPDD 225AL...	
<input type="checkbox"/> GINPDD 30AL...	

## INTERNAL CORNERS - pack. 10 Pcs

Article	€/Pc	€/pack
<input type="checkbox"/> AIPDD 175AL.../10		
<input type="checkbox"/> AIPDD 205AL.../10		
<input type="checkbox"/> AIPDD 225AL.../10		
<input type="checkbox"/> AIPDD 30AL.../10		

## HOW TO REQUEST SEASIDE TREATMENT

When placing your order please add S to the article's number  
 Example: PDD 175ALGF (seaside) = **PDD 175ALGFS**  
 price for seaside treatment +50% on the gross price.



GINPDD ...AL...

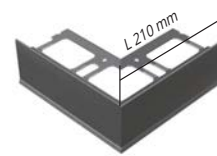

AEPDD ...



AIPDD ...

## EMBOSSED COLOURS

<b>BF - White (9010)</b>	<b>GF - Grey (7038)</b>	<b>A - Anthracite grey (no RAL)</b>	<b>TF - Dark brown (8019)</b>

## COLOURS ON DEMAND

EMBOSSED		SEMIGLOSSY			
<b>EF - Beige (1019)</b>	<b>C - Corten</b>	<b>B - White (9010)</b>	<b>G - Grey (7038)</b>	<b>E - Beige (1019)</b>	<b>T - Dark brown (8019)</b>

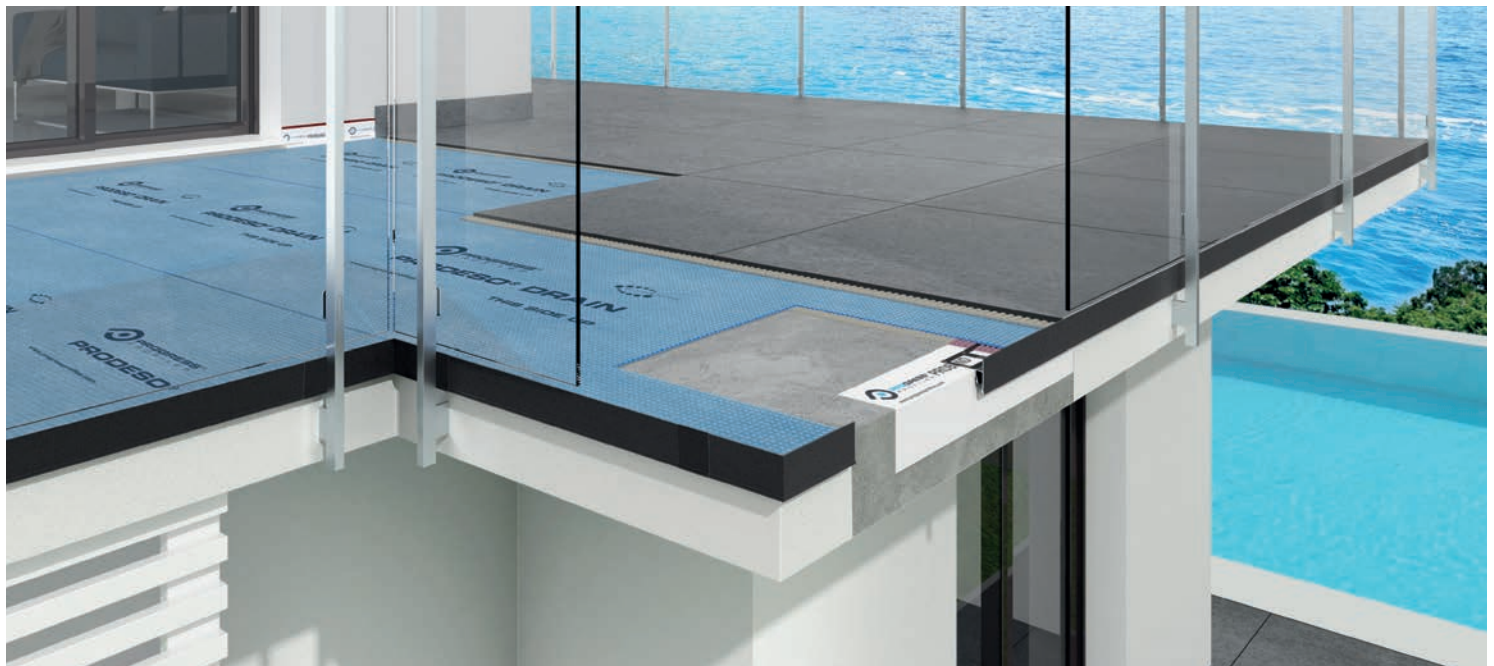





**PROTERRACE DRAIN DRIP** is an edging profile in varnished aluminium, designed to protect the edges of the tiles on terraces and balconies and to allow the downflow of water. The profile is provided with a flange that ensures the right fixing and an adhesive stripe, which protect the outflow holes to be closed by silicone. To reach a right connection between profile and the waterproofing system it's needed to use **PROBAND 150** with **PROBAND KOLL/AB**. The product is also available on request with a **SPECIAL SEASIDE PRE-TREATMENT** which increases its resistance to corrosion when installed at sea front environments.

# PROTERRACE DRAIN DRIP

VARNISHED/COATED ALUMINIUM

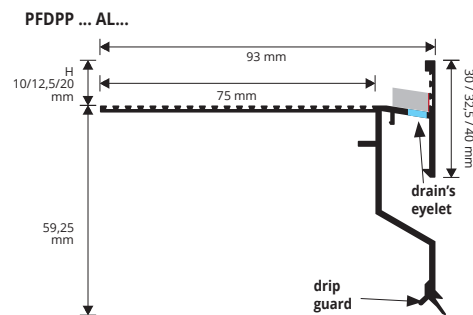
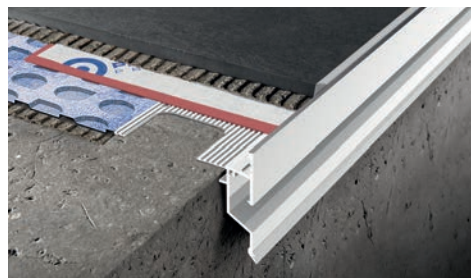
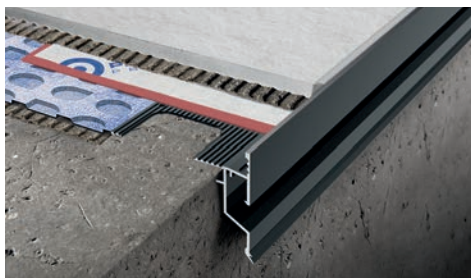

## VARNISHED/COATED ALUMINIUM

bar length 2,7 lm - pack. 5 Pcs - 13,5 lm

Article	H mm	€/lm	€/Pc
PFDPP 10AL...	10		
PFDPP 125AL...	12,5		
PFDPP 20AL...	20		

Available in the colours: BF - GF - A - TF (EF - C - B - G - E - T on demand). The code of the selected colour must be added to the article code. E.g.: PFDPP 10 AL... (white) PFDPP 10 ALBF.

## END CAPS - Pack. 2 PCS

Article	€/Pc	€/pack
TPFDPP AL.../2		

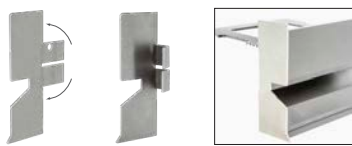

TPFDPP...

## EXTERNAL CORNERS - pack. 10 Pcs

Article	€/Pc	€/pack
AEPFDPP 10AL.../10		
AEPFDPP 125AL.../10		
AEPFDPP 20AL.../10		

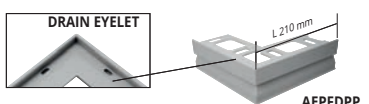

## INTERNAL CORNERS - pack. 10 Pcs

Article	€/Pc	€/pack
AIPFDPP 10AL.../10		
AIPFDPP 125AL.../10		
AIPFDPP 20AL.../10		

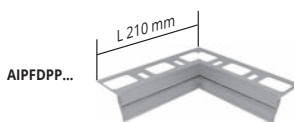

## JOINTS - pack. 1 upper + 1 lower

Article	€/Pack
GINFDPP 10AL .../1	
GINFDPP 125AL .../1	
GINFDPP 20AL .../1	



GINFDPP...

## EMBOSSED COLOURS

BF - White (9010)	GF - Grey (7038)	A - Anthracite grey (no RAL)	TF - Dark brown (8019)

## COLOURS ON DEMAND

EMBOSSED		SEMIGLOSSY			
EF - Beige (1019)	C - Corten	B - White (9010)	G - Grey (7038)	E - Beige (1019)	T - Dark brown (8019)

## EXAMPLES AND INSTRUCTIONS FOR LAYING METHODS

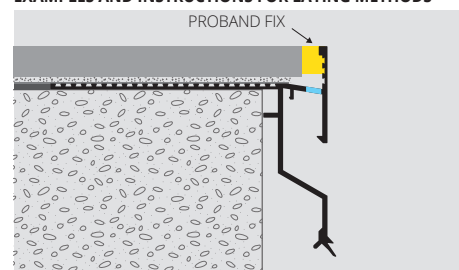

1. Choose PROTERRACE DRAIN DRIP according to the tile thickness and desired colour.
2. Fix the external corners to the screed (at least 1 cm from it) with nails.
3. Fix the draining adhesive stripe in polyurethane on the vertical side of the profile.
4. Cut the PROTERRACE DRAIN FDP at desired length joining it to the corners using the linking elements and fix it with nails to the substrate.
5. Lay the desired waterproofing system.
6. Lay the tiles leaving at 5 mm between the tile and the profile.
7. Seal the space between tile and profile with **PROBAND FIX (PRBFX)**.

## HOW TO REQUEST SEASIDE TREATMENT

When placing your order please add S to the article's number  
 Example: PFDPP 10ALGF (seaside) = **PFDPP 10ALGFS**  
 price for seaside treatment +50% on the gross price.



# PRO TERRACE DRAIN FDP

VARNISHED/COATED ALUMINIUM

PFDP 10AL...

scale 1:2

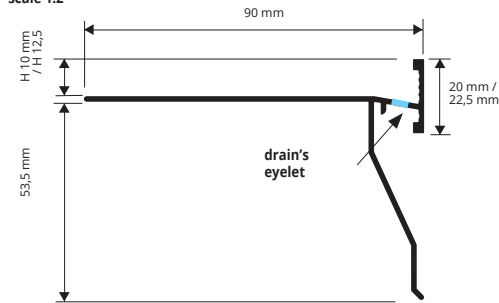

EXAMPLES AND INSTRUCTIONS FOR LAYING METHODS

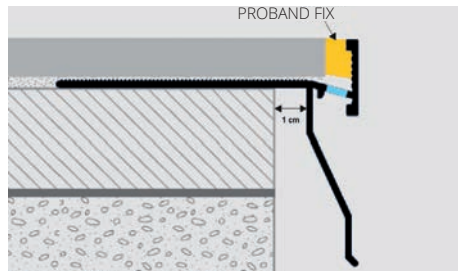

1. Choose PRO TERRACE DRAIN FDP according to the tile thickness and desired colour.
2. Fix the external corners to the screed with nails taking care to separate them at least 1 cm from it.
3. Cut "PRO TERRACE DRAIN FDP" to the desired length. Lay the profile and fix it with nails. Connect it with the corners using the junctions.
4. Apply the desired waterproofing system.
5. Lay the tiles, leaving about 5 mm between tiles and profile.
6. Seal the space between tiles and profile with PROBAND FIX (PRBFX).

## HOW TO REQUEST SEASIDE TREATMENT

When placing your order please add S to the article's number  
 Example: PFDP 10ALGF (seaside) = **PFDP 10ALGFS**  
 price for seaside treatment +50% on the gross price.

PRO TERRACE DRAIN FDP is an edging profile in varnished aluminium designed to protect the edges of the tiles laid on terraces and balconies and to allow a correct water discharge. The profile is equipped with a punched flange that ensures its fixing to the support. The profile is also provided with holes that allow the discharge of the water filtered between the profile and tiles. To reach a right connection between profile and the waterproofing system it's needed to use PROBAND 150 with PROBAND KOLL/AB. The product is also available on request with a **SPECIAL SEASIDE PRE-TREATMENT** which increases its resistance to corrosion when installed at sea front environments.

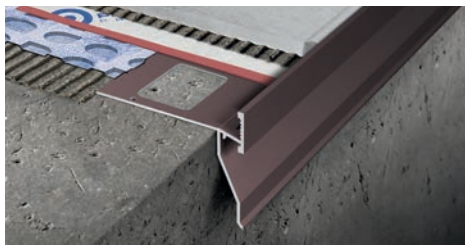

VARNISHED/COATED ALUMINIUM

bar length 2,7 lm - pack. 5 Pcs - 13,5 lm

Article	H mm	€/lm	€/Pc
PFDP 10AL...	10		
PFDP 125AL...	12,5		

Available in the colours: BF - GF - A - TF (EF - C - B - G - T - E on demand)  
 The code of the selected colour must be added to the article code.  
 E.g.: PFDP 10 AL... (white) PFDP 10 ALB.

## EMBOSSED COLOURS

Article	Color	Code
BF	White	(9010)
GF	Grey	(7038)
A	Anthracite grey (no RAL)	
TF	Dark brown	(8019)

## COLOURS ON DEMAND

EMBOSSED	
EF - Beige (1019)	C - Corten

SEMIGLOSSY			
B - White (9010)	G - Grey (7038)	E - Beige (1019)	T - Dark brown (8019)

EXTERNAL CORNERS - pack. 10 Pcs

Article	€/Pc	€/Pack.
AEPFDP 10AL.../10		
AEPFDP 125AL.../10		

INTERNAL CORNERS - pack. 10 Pcs

Article	€/Pc	€/Pack.
AIPFDP 10AL.../10		
AIPFDP 125AL.../10		

JOINTS - pack. 1 Pc upper + 1 Pc lower

Article	H mm	€/Pack.
GINFDP ...AL .../1	10/125	

Choose the desired height and finish.  
 E.g.: 10 mm joint with finish A - GINFDP 10ALA/10

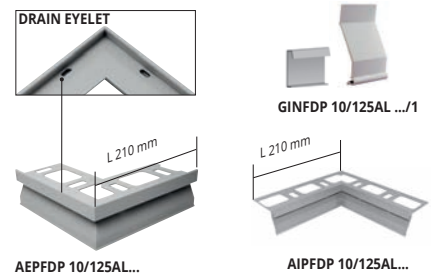

# PROSIDE WALK

VARNISHED/COATED ALUMINIUM

PSDWK 10AL / 125AL / 15AL / 20AL

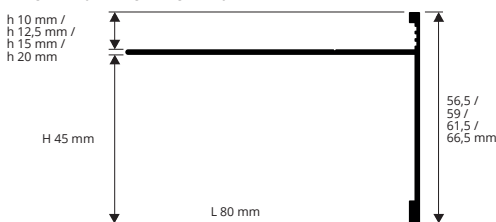

EXAMPLES AND INSTRUCTIONS FOR LAYING METHODS

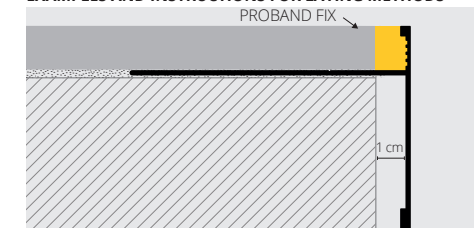

1. Choose PROSIDE WALK according to the tile thickness and desired colour.
  2. Waterproof with PROBAND 150 and PROBAND KOLL the front of the screed.
  3. Fix the external corners with nails.
  4. Cut PROSIDE WALK to the desired length and fix it with nails; connect it with the corners using the junction element.
  5. Lay the tiles, leaving about 5 mm between tiles and profile.
  6. Seal the space between tiles and profile with PROBAND FIX (PRBFX).
- PROFILE BENDING:** 1) Cut the anchoring flange into sections and engrave the metal close to the vertical side 2) bend the profile with the help of a template;

## HOW TO REQUEST SEASIDE TREATMENT

When placing your order please add S to the article's number  
 Example: PSDWK 10ALGF (seaside) = **PSDWK 10ALGFS**  
 price for seaside treatment +50% on the gross price.

PROSIDE WALK is a perimeter profile in varnished aluminium, available in grey and anthracite colour. It is designed to protect the edges of the tiles and the screed on pavements. The profile is equipped with a punched flange that ensures its fixing to the support. The flange is also provided with small holes that allow the momentary fixing of the profile with nails. To reach a right connection between profile and the waterproofing system it's needed to use PROBAND 150 with PROBAND KOLL/AB. The product is also available on request in **BENDABLE VERSION** and with a **SPECIAL SEASIDE PRE-TREATMENT** which increases its resistance to corrosion when installed at sea front environments.



VARNISHED EMBOSSED ALUMINIUM

bar length 2,7 lm - pack. 20 Pcs - 54 lm

Article	h mm	H mm	L	€/lm	€/Pc
PSDWK 10AL...	10	45	80		
PSDWK 125AL...	12,5	45	80		
PSDWK 15AL...	15	45	80		
PSDWK 20AL...	20	45	80		

## EMBOSSED COLOURS

Article	Color	Code
A	Anthracite grey (no RAL)	
GF	Gray	(7038)
TF	Dark brown	(8019)

## EMBOSSED COLOURS ON DEMAND

Article	Color	Code
BF	White	(9010)
C	Corten	
EF	Beige	(1019)

EXTERNAL CORNERS - pack. 10 Pcs

Article	h mm	H mm	L	€/Pc	€/Pack.
AEPSDWK 10AL.../10	10	45	80		
AEPSDWK 125AL.../10	12,5	45	80		
AEPSDWK 15AL.../10	15	45	80		
AEPSDWK 20AL.../10	20	45	80		

JOINTS - pack. 10 Pcs

Article	H mm	€/Pc	€/Pack.
GINSDWK ...AL.../10	10/125/15/20		

Choose the desired height and finish.  
 E.g.: 10 mm joint with finish A - GINSDWK 10ALA/10

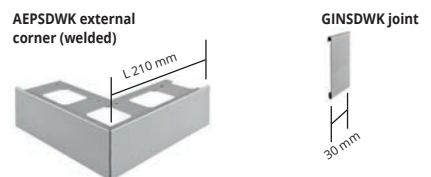

**PROTERRACE ECO DRIP** is an edging profile in aluminium designed to protect the front of the screed from water penetration and the edges of the tiles laid on terraces and balconies. The profile is equipped with a punched flange that ensures its fixing to the support. The front side of the profile is equipped with a double drip to improve the push away of water from the wall. To reach a right connection between profile and the waterproofing system it's needed to use **PROBAND 150** with **PROBAND KOLL/AB**. The product is also available on request in **BENDABLE VERSION** and with a **SPECIAL SEASIDE PRE-TREATMENT** which increases its resistance to corrosion when installed at sea front environments.

# PROTERRACE ECO DRIP

VARNISHED/COATED ALUMINIUM

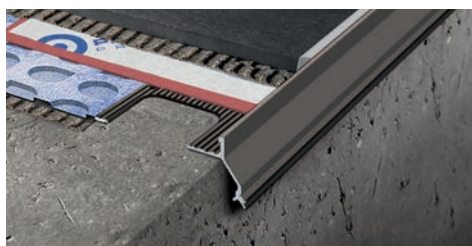

VARNISHED/COATED ALUMINIUM bar length 2,7 lm - pack 20 Pcs - 54 lm

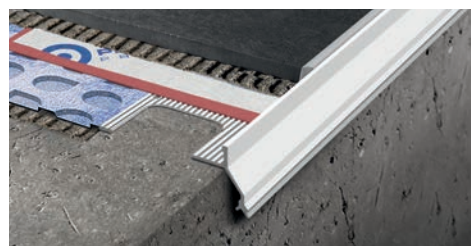

EXTERNAL CORNER - pack 10 Pcs

Article	H mm	€/lm	€/Pc
PTEDP 10AL...	10		
PTEDP 125AL...	12,5		

Available in the colours: BF - GF - A - TF (EF - C - B - G - E - T on demand)  
The code of the selected colour must be added to the article code.  
E.g.: PTEDP 10AL... (gray) PTEDP 10GFAL...

JOINTS - pack 2 / 10 Pcs

Article	€/pack. 2Pcs	€/pack. 10Pcs
GINEDP 10AL... /...		
GINEDP 125AL... /...		

EMBOSSED COLOURS

BF - White (9010)	GF - Grey (7038)	A - Anthracite grey (no RAL)	TF - Dark brown (8019)

Article	€/Pc	€/Pack
AEEDP 10AL.../10		
AEEDP 125AL.../10		

GINEDP 10/125ALGF



AEEDP 10/125ALGF

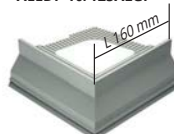

COLOURS ON DEMAND

SEMIGLOSSY			
B - White (9010)	G - Grey (7038)	E - Beige (1019)	T - Dark brown (8019)

EMBOSSED

EF - Beige (1019)	C - Corten

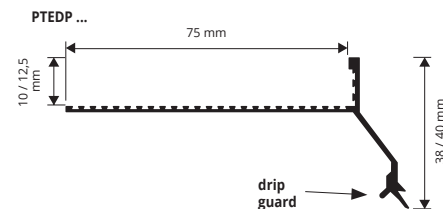

EXAMPLES AND INSTRUCTIONS FOR LAYING METHODS

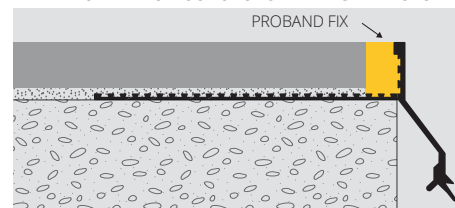

1. Choose "PROTERRACE ECO DRIP" according to the tile thickness.
  2. Cut "PROTERRACE ECO DRIP" to the desired length and fix it to the support with nails.
  3. Apply the desired waterproofing system, sealing the joint between profile and waterproofing.
  4. Lay the tiles, leaving about 5 mm between tiles and profile.
  5. Seal the space between tiles and profile using **PROBAND FIX (PRBFX)**.
- PROFILE BENDING:** 1) Cut the anchoring flange into sections and engrave the metal close to the vertical side 2) bend the profile with the help of a template;

HOW TO REQUEST SEASIDE TREATMENT

When placing your order please add S to the article's number  
Example: PTEDP 10ALGF (seaside) = **PTEDP 10ALGFS**  
*price for seaside treatment +50% on the gross price.*

**PROTERRACE ECO** is a natural aluminium edging profile designed to protect the edges of the tiles laid on terraces and balconies. The profile is provided with a punched flange that ensures its fixing to the support. The front side of the profile protects the tile edges and is equipped with grooves that facilitate the grout grip. Thanks to its ease of application **PROTERRACE ECO** is a much sought after profile. To reach a right connection between profile and the waterproofing system it's needed to use **PROBAND 150** with **PROBAND KOLL/AB**. The product is also available on request in **BENDABLE VERSION**

# PROTERRACE ECO

ALUMINIUM



NATURAL ALUMINIUM thermo packed  
bar length 2,7 lm - pack 20 Pcs - 54 lm

Article	H mm	€/lm	€/Pc
PTEE 08AN	8		
PTEE 10AN	10		
PTEE 125AN	12,5		

SILVER ANODIZED ALUMINIUM thermo packed  
bar length 2,7 lm - pack 20 Pcs - 54 lm

Article	H mm	€/lm	€/Pc
PTEE 08AA	8		
PTEE 10AA	10		
PTEE 125AA	12,5		

COLOURS

AN - Natural aluminium	AA - Anodized silver alum.

ARTICLES NOT FOR SALE SINGLY

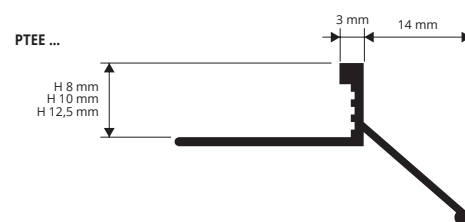

EXAMPLES AND INSTRUCTIONS FOR LAYING METHODS

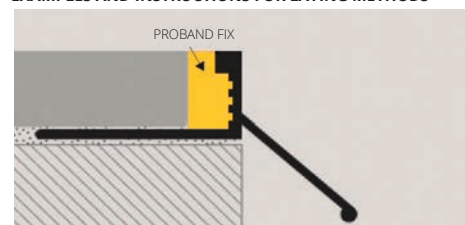

1. Choose "PROTERRACE ECO" according to the tile thickness.
  2. Cut "PROTERRACE ECO" to the desired length and fix it to the support with nails.
  3. Apply the desired waterproofing system, sealing the joint between profile and waterproofing.
  4. Lay the tiles, leaving about 5 mm between tiles and profile.
  5. Seal the space between tiles and profile using **PROBAND FIX (PRBFX)**.
- PROFILE BENDING:** 1) Cut the anchoring flange into sections and engrave the metal close to the vertical side 2) bend the profile with the help of a template;



# PROTERRACE PCG

POLISHED STAINLESS STEEL AISI 304/1.4301-V2A

**PROTERRACE PCG** is an edging profile in polished stainless steel INOX AISI 304/1.4301-V2A designed to protect the edges of the tiles laid on terraces and balconies and to allow a correct water discharge. The profile is equipped with a punched flange that ensures its fixing to the support. The flange is also provided with small holes that allow the momentary fixing of the profile with nails. The availability of special pieces such as external corners and junctions make **PROTERRACE PCG** a much sought after and easy to lay profile. The product is also available on request in **BENDABLE VERSION**

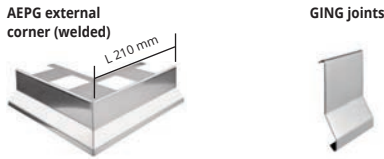
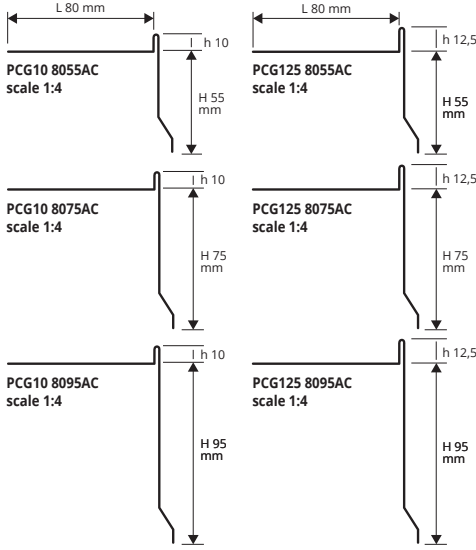

POLISHED STAINLESS STEEL AISI 304/1.4301-V2A with protective film  
bar length 2,7 lm - pack. 5 Pcs - 13,5 lm (H 55 mm - 18,9 lm)

Article	h x H x L mm	€/lm	€/Pc
PCG10 8055AC	10 x 55 x 80		
PCG10 8075AC	10 x 75 x 80		
PCG10 8095AC	10 x 95 x 80		
PCG125 8055AC	12,5 x 55 x 80		
PCG125 8075AC	12,5 x 75 x 80		
PCG125 8095AC	12,5 x 95 x 80		

EXTERNAL CORNERS - pack. 10 Pcs

Article	€/Pc	€/Pack.
AEPG10 55AC/75AC/95AC/10		
AEPG125 55AC/75AC/95AC/10		

EXAMPLES AND INSTRUCTIONS FOR LAYING METHODS

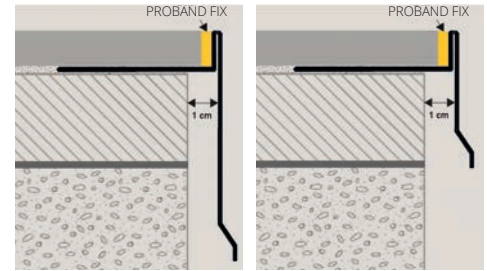

1. Choose "PROTERRACE PCG" according to the tile thickness. 2. Fix the external corners to the screed with nails taking care to separate them at least 1 cm from it. 3. Cut "PROTERRACE PCG" to the desired length. Lay the profile and fix it with nails. Connect it with the corners using the junctions. 4. Apply the desired waterproofing system. 5. Lay the tiles, leaving about 5 mm between tiles and profile. 6. Seal the space between tiles and profile with **PROBAND FIX (PRBFX)**.

**PROFILE BENDING:** 1) Cut the anchoring flange into sections and engrave the metal close to the vertical side 2) bend the profile with the help of a template;

JOINTS - pack. 10 Pcs

Article	€/Pc	€/Pack.
GING10 55AC/75AC/95AC/10		
GING125 55AC/75AC/95AC/10		

\* Corners and joints of the on demand profiles are also on demand

# PROTERRACE PCG

VARNISHED/COATED ALUMINIUM

**PROTERRACE PCG** is an edging profile designed to protect the edges of the tiles laid on terraces and balconies and to allow a correct water discharge. The profile is equipped with a punched flange that ensures its fixing to the support and which is also provided with small holes that allow the momentary fixing of the profile with nails. The availability of special pieces such as external corners and junctions make **PROTERRACE PCG** a much sought after and easy to lay profile. To reach a right connection between profile and the waterproofing system it's needed to use **PROBAND 150** with **PROBAND KOLL/AB**. The product is also available on request with a **SPECIAL SEASIDE PRE-TREATMENT** which increases its resistance to corrosion when installed at sea front environments. The product is also available on request in **BENDABLE VERSION**

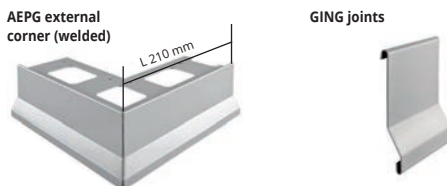
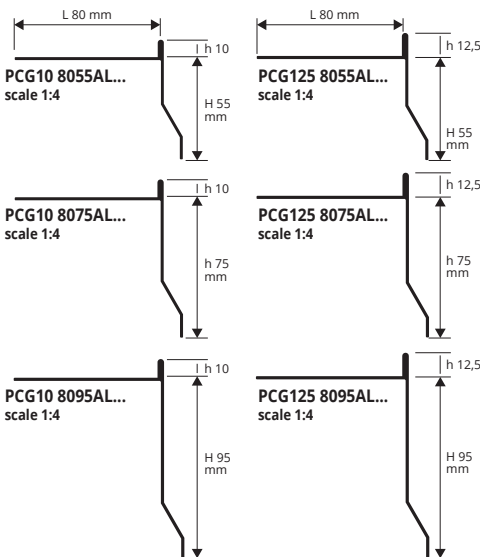

VARNISHED/COATED ALUMINIUM  
bar length 2,7 lm - pack. 5 Pcs - 13,5 lm (H 55 mm - 18,9 lm)

Article	h x H x L mm	€/lm	€/Pc
PCG10 8055AL...	10 x 55 x 80		
PCG10 8055ALG	10 x 55 x 80		*
PCG10 8075AL...	10 x 75 x 80		
PCG10 8075ALG	10 x 75 x 80		*
PCG10 8095AL...	10 x 95 x 80		
PCG10 8095ALG	10 x 95 x 80		*
PCG125 8055AL...	12,5 x 55 x 80		
PCG125 8075AL...	12,5 x 75 x 80		
PCG125 8095AL...	12,5 x 95 x 80		

Available in the colours: BF - GF - A - TF (EF - C - B - G - T - E on demand). The code of the selected colour must be added to the article code. E.g.: PCG10 8055AL... (white) PCG10 8055ALB.

EXEMPLES OF LAYING (for laying instructions, see above)

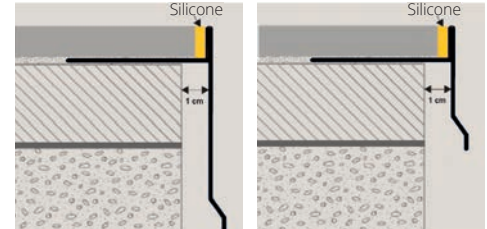

EMBOSSED COLOURS

BF - White (9010)	GF - Grey (7038)	A - Anthracite grey (no RAL)	TF - Dark brown (8019)
-------------------	------------------	------------------------------	------------------------

COLOURS ON DEMAND

EMBOSSED	
EF - Beige (1019)	C - Corten

SEMIGLOSSY

B - White (9010)	G - Grey (7038)	E - Beige (1019)	T - Dark brown (8019)
------------------	-----------------	------------------	-----------------------

EXTERNAL CORNERS - pack. 10 Pcs

Article	€/Pc	€/Pack.
AEPG10 55AL.../75AL.../95AL.../10		
AEPG125 55AL.../75AL.../95AL.../10		

JOINTS - pack. 10 Pcs

Article	€/Pc	€/Pack.
GING10 55AL.../75AL.../95AL.../10		
GING125 55AL.../75AL.../95AL.../10		

The code of the selected colour must be added to the article code. E.g.: AEPG10 55AL... (white) AEPG10 55ALB.

\* Corners and joints of the on demand profiles are also on demand

\* = Production on demand with minimum quantity of 100 pcs. Production delay 4/5 weeks. Price to be agreed

Prices are referred to whole packs, 10% increase for minimum orders of 10 pcs, 20% increase for orders of less than 10 pcs.

**PROTERRACE PC** is a perimeter profile in polished stainless steel inox aisi 304/1.4301-V2A designed to protect the screed on terraces and balconies and to allow a correct water discharge. The profile is equipped with a punched flange that ensures its fixing to the support. The flange is also provided with small holes that allow the momentary fixing of the profile with nails. To reach a right connection between profile and the waterproofing system it's needed to use **PROBAND 150** with **PROBAND KOLL/AB**. The product is also available on request in **BENDABLE VERSION**.

# PROTERRACE PC

POLISHED STAINLESS STEEL AISI 304/1.4301-V2A



**POLISHED STAINLESS STEEL AISI 304/1.4301-V2A with protective film**  
bar length 2,7 lm - pack. 7 Pcs - 18,9 lm (H 75 mm - 13,5 lm - H 95 mm - 5,4 lm)

Article	L x H mm	€/lm	€/Pc
PC 8055AC	80 x 55		
PC 8075AC	80 x 75		*
PC 8095AC	80 x 95		*

## EXAMPLES AND INSTRUCTIONS FOR LAYING METHODS

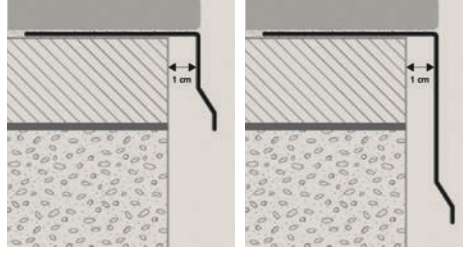

1. Choose "PROTERRACE PC" according to the desired height. 2. Fix the external corners to the screed with nails taking care to separate them at least 1 cm from it. 3. Cut "PROTERRACE PC" to the desired length. Lay the profile and fix it with nails. Connect it with the corners using the junctions. 4. Apply the desired waterproofing system. 5. Lay the tiles. **PROFILE BENDING:** 1) Cut the anchoring flange into sections and engrave the metal close to the vertical side 2) bend the profile with the help of a template;

PC 8055AC  
scale 1:4

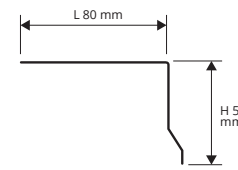

PC 8075AC  
scale 1:4

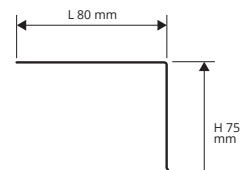

PC 8095AC  
scale 1:4

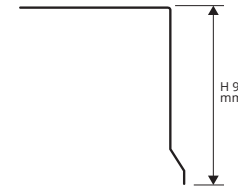

## EXTERNAL CORNERS - pack. 10 Pcs

Article	€/Pc	€/Pack.
AEPC 55AC/75AC/95AC/10		

\* Corners and joints of the on demand profiles are also on demand

## JOINTS - pack. 10 Pcs

Article	€/Pc	€/Pack.
GINC 55AC/75AC/95AC/10		

AEPC external corner (welded)

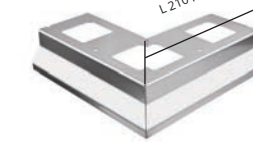

GINC joints



**PROTERRACE PC** is a perimeter profile in varnished aluminium designed to protect the screed on terraces and balconies and to allow a correct water discharge. The profile is equipped with a punched flange that ensures its fixing to the support. The flange is also provided with small holes that allow the momentary fixing of the profile with nails. To reach a right connection between profile and the waterproofing system it's needed to use **PROBAND 150** with **PROBAND KOLL/AB**. The product is also available on request with a **SPECIAL SEASIDE PRE-TREATMENT** which increases its resistance to corrosion when installed at sea front environments. The product is also available on request in **BENDABLE VERSION**.

# PROTERRACE PC

VARNISHED/COATED ALUMINIUM



**VARNISHED/COATED ALUMINIUM - bar length 2,7 lm**  
pack. 7 Pcs - 18,9 lm (H 75 mm - 13,5 lm - H 95 mm - 5,4 lm)

Article	L x H mm	€/lm	€/Pc
PC 8055AL...	80 x 55		*
PC 8075AL...	80 x 75		*
PC 8095AL...	80 x 95		*

The code of the selected colour must be added to the article code. E.g.: PC 8055AL... (white) PC 8055ALB.

## SEMIGLOSSY COLOURS ON DEMAND

B - White (9010)	G - Grey (7038)	T - Dark brown (8019)
E - Beige (1019)		

## EXTERNAL CORNERS - pack. 10 Pcs

Article	€/Pc	€/Pack.
AEPC 55AL.../75AL.../95AL.../10		

The code of the selected colour must be added to the article code. E.g.: AEPC 55AL... (white) AEPC 55ALB.

\* Corners and joints of the on demand profiles are also on demand

## EXAMPLES AND INSTRUCTIONS FOR LAYING METHODS

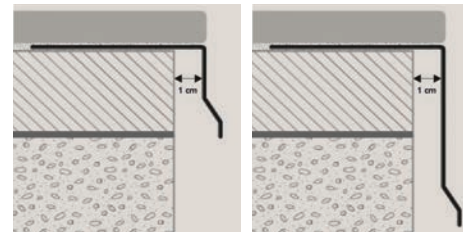

1. Choose "PROTERRACE PC" according to the desired colour and height. 2. Fix the external corners to the screed with nails taking care to separate them at least 1 cm from it. 3. Cut "PROTERRACE PC" to the desired length. Lay the profile and fix it with nails. Connect it with the corners using the junctions. 4. Apply the desired waterproofing system. 5. Lay the tiles. **PROFILE BENDING:** 1) Cut the anchoring flange into sections and engrave the metal close to the vertical side 2) bend the profile with the help of a template;

PC 8055AL  
scale 1:4

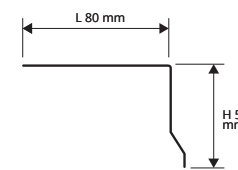

PC 8075AL  
scale 1:4

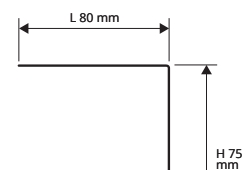

PC 8095AL  
scale 1:4

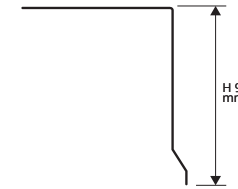

## EMBOSSSED COLOURS ON DEMAND

BF - White (9010)	GF - Grey (7038)	A - Anthracite grey (no RAL)
EF - Beige (1019)	C - Corten	TF - Dark brown (8019)

## JOINTS - pack. 10 Pcs

Article	€/Pc	€/Pack.
GINC 55AL.../75AL.../95AL.../10		

## HOW TO REQUEST SEASIDE TREATMENT

When placing your order please add S to the article's number  
Example: PC 8055ALGF (seaside) = **PC 8055ALGFS**  
price for seaside treatment +50% on the gross price.

AEPC external corners (welded)

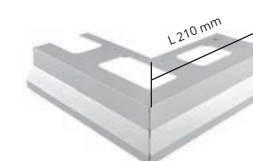

GINC joints



\* = Production on demand with minimum quantity of 100 pcs. Production delay 4/5 weeks. Price to be agreed

Prices are referred to whole packs, 10% increase for minimum orders of 10 pcs, 20% increase for orders of less than 10 pcs.



# PROTERRACE PCJ

VARNISHED/COATED ALUMINIUM

**PROTERRACE PCJ** is an edging profile in varnished aluminium designed to protect the screed and the edges of the tiles laid on terraces and balconies. The profile is equipped with a punched flange that ensures its fixing to the support. The flange is also provided with small holes with a diameter of 2.5 mm that allow the momentary fixing of the profile with nails. To reach a right connection between profile and the waterproofing system it's needed to use **PROBAND 150** with **PROBAND KOLL/AB**. The product is also available on request with a **SPECIAL SEASIDE PRE-TREATMENT** which increases its resistance to corrosion when installed at sea front environments.

PCJ10 8055AL...  
scale 1:4

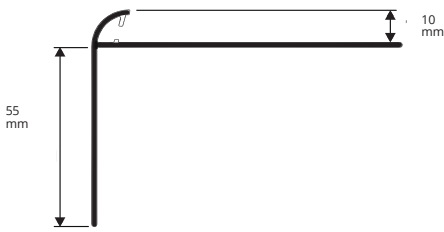

VARNISHED/COATED ALUMINIUM - bar length 2,7 lm  
pack. 7 Pcs 18,9 lm (H 75 mm - 13,5 lm - H 95 mm - 5,4 lm)

Article	h x H x L mm	€/lm	€/Pc
PCJ10 8055AL...	10 x 55 x 80		

Available in the colours: BF - GF - A (EF - C - TF - B - G - T - E on demand).  
The code of the selected colour must be added to the article code. E.g.:  
PCJ10 8055AL... (white) PCJ10 8055ALB.

AEPJ external corner (welded)

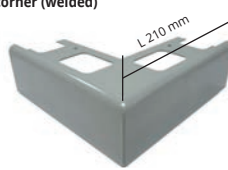

GINJ joints



EXTERNAL CORNERS - pack. 10 Pcs

Article	€/Pc	€/Pack.
AEPJ10 55AL.../10		

JOINTS - pack. 10 Pcs

Article	€/Pc	€/Pack.
GINJ10 55AL.../10		

\* Corners and joints of the on demand profiles are also on demand

EMBOSSED COLOURS

BF - White (9010)	GF - Grey (7038)	A - Anthracite grey (no RAL)
-------------------	------------------	------------------------------

COLOURS ON DEMAND

EMBOSSED		
EF - Beige (1019)	C - Corten	TF - Dark brown (8019)
SEMIGLOSSY		
B - White (9010)	G - Grey (7038)	T - Dark brown (8019)
E - Beige (1019)		

HOW TO REQUEST SEASIDE TREATMENT

When placing your order please add S to the article's number  
Example: PCJ10 8055ALGF (seaside) = **PCJ10 8055ALGFS**  
*price for seaside treatment +50% on the gross price.*

Available in the colours: BF - GF - A (EF - C - TF - B - G - T - E on demand). The code of the selected colour must be added to the article code.  
E.g.: AEPJ10 55AL... (white) AEPJ10 55ALB.

## EXAMPLES AND INSTRUCTIONS FOR LAYING METHODS

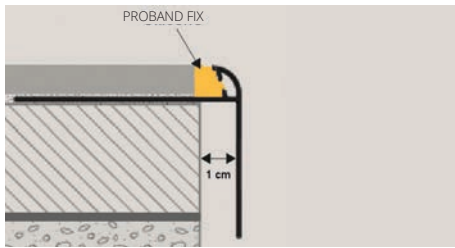

1. Choose "PROTERRACE PCJ" according to the tile thickness and desired colour.
2. Fix the external corners to the screed with nails taking care to separate them at least 1 cm from it.
3. Cut "PROTERRACE PCJ" to the desired length. Lay the profile and fix it with nails. Connect it with the corners using the junctions.
4. Apply the desired waterproofing system.
5. Lay the tiles, leaving about 5 mm between tiles and profile.
6. Seal the space between tiles and profile with **PROBAND FIX (PRBFX)**.

# PROTERRACE PTER

POLISHED STAINLESS STEEL AISI 304/1.4301-V2A

**PROTERRACE PTER** is a perimeter profile in polished stainless steel inox aisi 304/1.4301-V2A designed to protect the screed on terraces and balconies. The profile is equipped with a punched flange that ensures its fixing to the support. The flange is also provided with small holes that allow the momentary fixing of the profile with nails. To reach a right connection between profile and the waterproofing system it's needed to use **PROBAND 150** with **PROBAND KOLL/AB**. The product is also available on request in **BENDABLE VERSION**.

PTER 8042AC  
scale 1:4

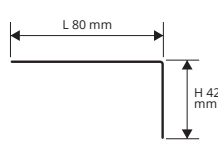

PTER 8055AC  
scale 1:4

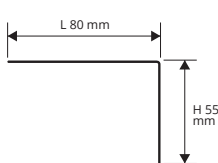

PTER 8075AC  
scale 1:4

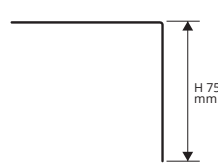

PTER 8095AC  
scale 1:4

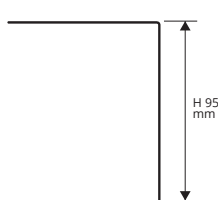

POLISHED STAINLESS ST. AISI 304/1.4301-V2A with protective film  
bar length 2,7 lm - pack. 10 Pcs - 27 lm

Article	L x H mm	€/lm	€/Pc
PTER 8042AC	80 x 42		
PTER 8055AC	80 x 55		
PTER 8075AC	80 x 75		
PTER 8095AC	80 x 95		

JOINTS - pack. 10 Pcs

Article	€/Pc	€/Pack.
GIN 42AC/55AC/75AC/95AC/10		

GIN joints



EXTERNAL CORNERS - pack. 10 Pcs

Article	€/Pc	€/Pack.
AEPR 42AC/55AC/75AC/95AC/10		

AEPR external corner (welded)

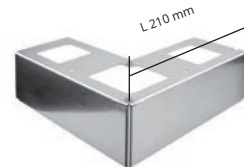

\* Corners and joints of the on demand profiles are also on demand

## EXAMPLES AND INSTRUCTIONS FOR LAYING METHODS

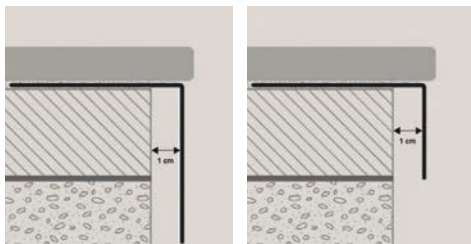

1. Choose "PROTERRACE PTER" according to the desired height.
2. Fix the external corners to the screed with nails taking care to separate them at least 1 cm from it.
3. Cut "PROTERRACE PTER" to the desired length. Lay the profile and fix it with nails. Connect it with the corners using the junctions.
4. Apply the desired waterproofing system.
5. Lay the tiles. **PROFILE BENDING:** 1) Cut the anchoring flange into sections and engrave the metal close to the vertical side 2) bend the profile with the help of a template;

\* = Production on demand with minimum quantity of 100 pcs. Production delay 4/5 weeks. Price to be agreed

Prices are referred to whole packs, 10% increase for minimum orders of 10 pcs, 20% increase for orders of less than 10 pcs.



**PROSHOWER LATERAL AND VERTICAL DRAIN KIT** are 2 central drain systems with lateral or vertical outflow equipped with a siphon, grate support, stainless steel grate, butyl double-sided ring for the fixing of the waterproof section, waterproof section and a protection cap with template function too that allows the correct positioning of the butyl ring and the waterproof section. LATERAL AND VERTICAL DRAIN KIT ensure a correct flow of rainwater.

# PROSHOWER DRAIN KIT

LATERAL AND VERTICAL DRAINS

Article	Description	Pc/Pack.	€/Pc
PSHLDK	PROSHOWER DRAIN LATERAL KIT	1	
PSHVDK	PROSHOWER DRAIN VERTICAL KIT	1	

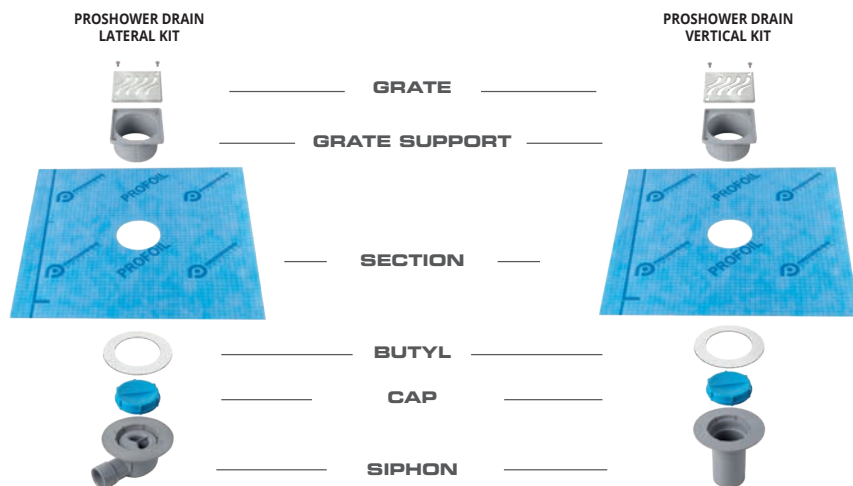

PROSHOWER DRAIN LATERAL KIT PSHLDK

PROSHOWER DRAIN VERTICAL KIT PSHVDK

### AREA OF USE

- **Use** - Balconies, terraces, outdoor surfaces of any size, kitchens and showers.
- **Don't use** - In environments subject to heavy traffic and where washing with acidic and strong alkaline substances is foreseen.

### WARNINGS

After the drain installation, apply the protective cap. Before applying the butyl double-sided adhesive ring on the flange of the drain, thoroughly clean the flange of any dirt residue that may compromise its adhesion. Apply the butyl double-sided adhesive ring and the waterproofing section during the application of the waterproofing system.

**PROSHOWER DRAIN CENTRAL PRO** is a 10x10 cm stainless steel AISI 316L / 1.4404 - V4A drain for the realisation of floor-level shower. This low thickness drain is equipped with a grid that can also be tiled for floor-level drains. PROSHOWER DRAIN CENTRAL PRO has excellent chemical resistance and is equipped with a 360° adjustable siphon.

# PROSHOWER DRAIN CENTRAL PRO

LATERAL DRAIN

PROSHOWER DRAIN CENTRAL PRO - GRATE + POLYSTYRENE CHANNEL PROTECTION + PROFOIL SECTION + DUCT BODY + SIPHON

Article	Description	Pc/Pack.	€/Pc
PSHWCP	PROSHOWER DRAIN CENTRAL PRO	1	

### AREA OF USE

- **Use** - PROSHOWER BASE L PRO it can be used in any indoor and outdoor environment.
- **Don't use** - In environments where very aggressive substances are used and a high concentrated load is expected.

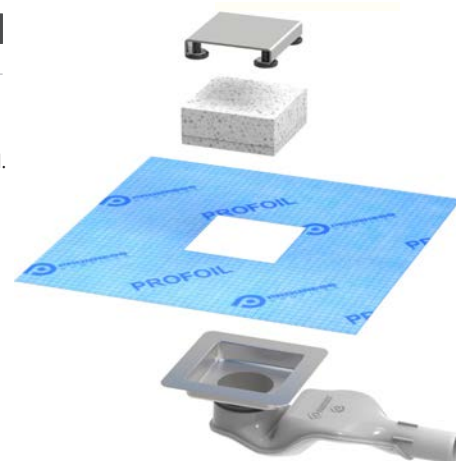

**PRODRIP** is a perimeter drain in ASA (Modified ABS) equipped with wall-floor junction. The junction is covered with non-woven polypropylene to ensure sealing with the used waterproofing system.

# PRODRIP

PERIMETRAL DRAIN

### PERIMETER DRAIN

pack. per pallet = 192

Article	Pcs/Pack.	€/Pc	€/Pack.
PDRP	4		

### AREA OF USE

- **Use** - To realise perimeter drains on balconies, terraces and outside horizontal surfaces of any size.
- **Don't use** - With bituminous waterproofing and as vertical drain.

### WARNINGS

Do not heat with direct flames and do not use adhesive with solvents.

Consult the data sheet prior to application in the case of special applications, we recommend that you consult the technical department.

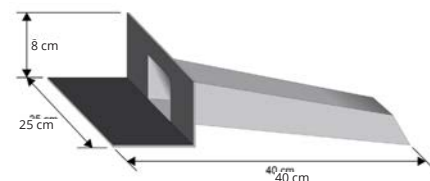

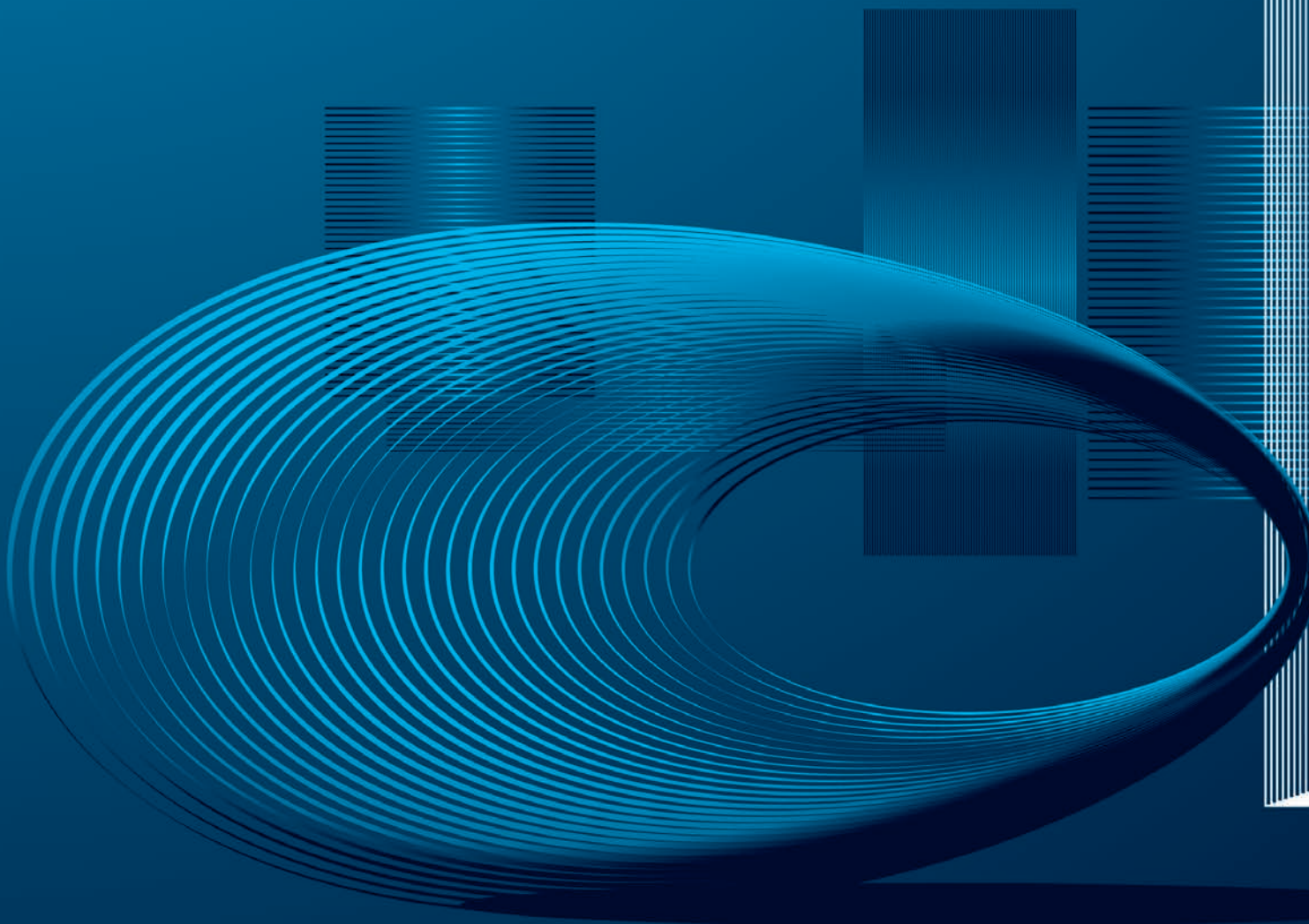

An interpretation of:  
**Museum of the Future, Shaun Killa,  
The Frame, Fernando Domis, DUBAI (United Arab Emirates), 2018**



MEMBRANE AND PANELS

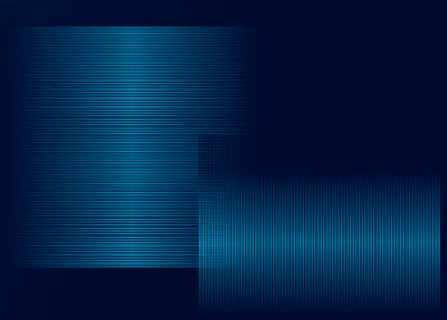
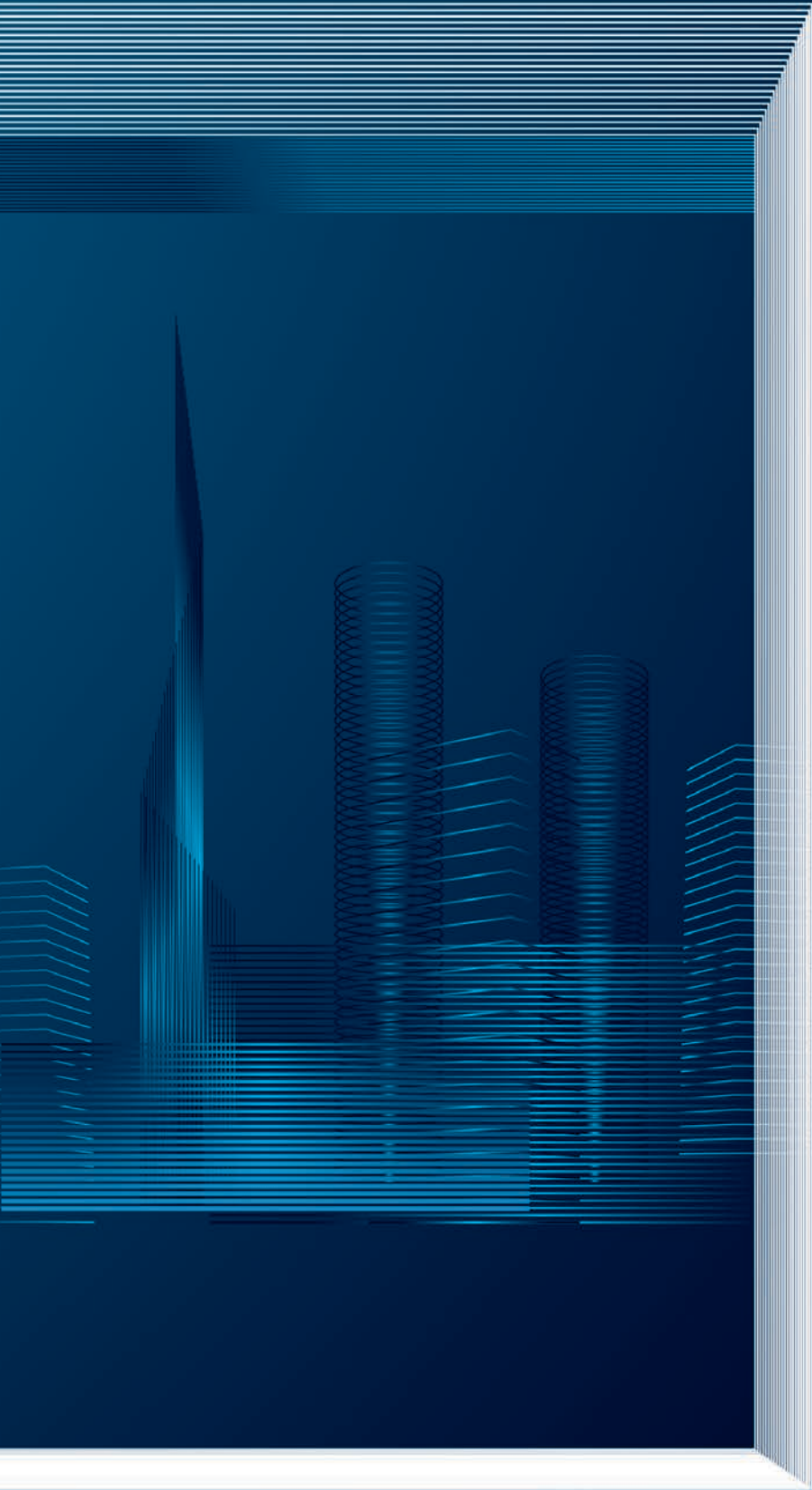



# PRODESO® DRAIN SYSTEM

WEBSITE



**PATENTED**



**PATENTED**

102018000005884

**Discover PRODESO® Drain!!** With its essential draining/waterproofing function guaranteed by the most advanced system in the world.

**PRODESO® DRAIN SYSTEM** is an innovative and patented membrane of last generation for the draining and waterproofing. The "air chamber" created under the tiles, facilitates a micro-ventilation that allows a drainage of water and a quick drying of the adhesive especially in case of large sizes. Reduces the risk deriving from the rise of triacetates present in the adhesives and the appearance of efflorescence in the joints. The membrane consists of a high density polyethylene sheet, with semicircular truncated pyramidal cavities, at the top of which is thermo-welded a polypropylene draining fabric; the lower part of the membrane has a hydrophobic polypropylene spunbond bonded to polyethylene, that extends on one side of about 7.5 cm beyond the polyethylene plate and is waterproofed for 15

cm with a polypropylene film; this spunbond guarantees the bonding to the support. To complete the system an elastic polyethylene tape covered on both sides with a polypropylene spunbond, a waterproof bicomponent adhesive, and a class C2S1 cement based adhesive to glue the membrane. **PRODESO® DRAIN** uncoupling and vapor management features allow its application on not perfectly cured substrates. Easy and quick to install, it has an overall thickness of only 5 mm, less than any other system. Versatility is an essential quality of this product. It guarantees long life to the flooring both outdoor and in the indoor humid environments, such as wellness centers, SPA and pools. An innovative technology that perfectly combines with a simplicity, speed and effectiveness of installation.

## Advantages



UNCOUPLING



ANTI-FRACTURE



WATERPROOFING



UNDERTILE FLOORING  
DRAINAGE / DRYING / MICRO-  
VENTILATION



VAPOUR MANAGEMENT



PRODESO® DRAIN SYSTEM is a waterproof, draining, uncoupling membrane that allows the vapour management, with a thickness of only 5/8 mm. The membrane is composed of a high density polyethylene sheet at the top of which is thermo-welded a polypropylene draining fabric; below is glued a non-woven polypropylene fabric. The semicircular truncated pyramidal cavities of the sheet, create an "air chamber" under the tiles which facilitates the air movement allows the drainage and rapid drying of the adhesive thus reducing the risk of the triacetates present in it rising and the formation of efflorescence in the joints. Thanks to its structure, PRODESO® DRAIN can also be applied on substrates that are not perfectly cured. Its draining capacity makes it particularly suitable for the laying of large size ceramic tiles slabs both indoors and outdoors.

# PRODESO® DRAIN SYSTEM

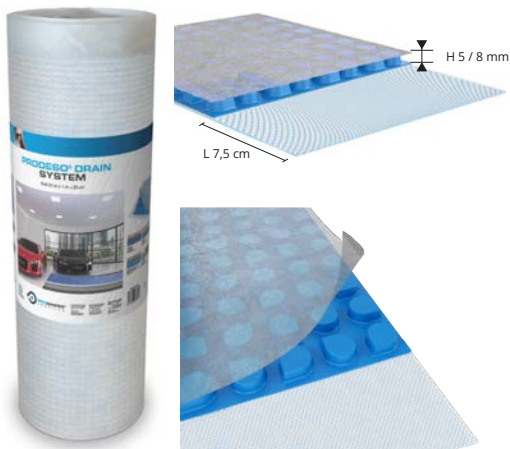

## PRODESO® DRAIN UNCOUPLING, DRAINING AND WATERPROOFING MEMBRANE - 20M<sup>2</sup>

Article	Description	H x L ML	Tot. m <sup>2</sup>
PDESDR 201/E	5 mm	(1 m x 20 ml = 20 m <sup>2</sup> )	20

## PRODESO® DRAIN UNCOUPLING, DRAINING AND WATERPROOFING MEMBRANE - 15M<sup>2</sup>

Article	Description	H x L ML	Tot. m <sup>2</sup>
PDESDR 151/E	8 mm	(1 m x 15 ml = 15 m <sup>2</sup> )	15

ARTICLE AVAILABLE FROM APRIL 2022

## PROBAND 250 - ELASTIC ROLLS IN HDPE AND PP - Thickness 0,42 mm

Article	H mm x L Im	Rolls/ Pack.
PRBPE 2530	250 x 30	3

For the indicative consumption of proband koll AB during the installation of the PROBAND, consult the technical data sheet of PROBAND 150/250



## PROBAND KOLL AB - FAST SETTING RED BICOMPONENT HYDROPHOBIC ADHESIVE

Pack of 15 Kg - pack/pallet = 27 Pcs - Kg/pallet 405 Kg.

Article	Pack. Kg.
PRBKLAB	15

For the indicative consumption of proband koll AB during the installation of the PROBAND, consult the technical data sheet of PROBAND 150/250

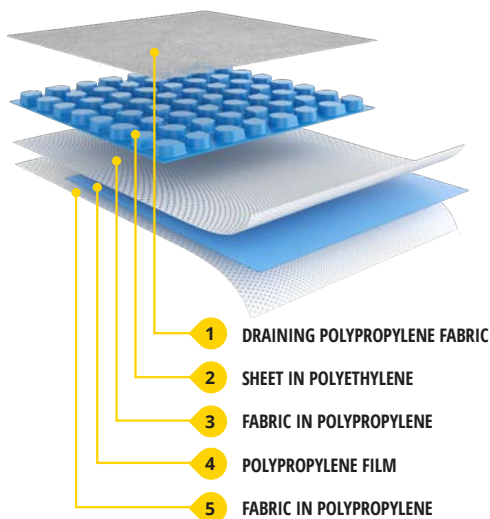

## LAYING'S SECTION

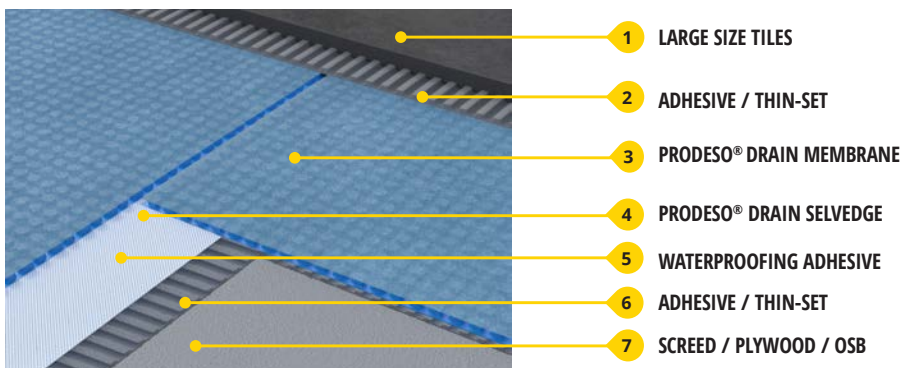



# PRODESO® HEAT GRIP SYSTEM

INSTRUCTION VIDEO



**PATENTED**



**PATENTED**

UA2016A002209  
 EP3225763 A1  
 003067388  
 2698795  
 CN 107268933 A  
 HK1238695  
 CA 2,935,062  
 US 9,726,383 B1  
 US, 10,502,434 B2  
 US 10,859,274 B2  
 US 10,215,423  
 US D818,615S  
 US D818,616S  
 US D818,617S  
 US D832,467S  
 US D841,837S  
 US D872,901S  
 US D874,028S  
 DESIGN PATENT  
 Patent pending

## A New evolution

with the goal of flexibility, innovation and energy efficiency

The system is composed of three elements: PRODESO® HEAT GRIP MEMBRANE, PRODESO® HEAT GRIP CABLE e PRODESO® HEAT GRIP THERMOSTAT KIT. The polyethylene membrane with uncoupling, waterproofing and vapour management features has a 8,5 mm thickness and a thermowelded non-woven fabric on the back side, which guarantees the adhesion to the substrate.

The new membrane structure allows a perfect fixing of the

heating cable and a crack-bridging ability 5 times more than the PRODESO® HEAT. The cables of last generation are composed of many resistances, each one 60 cm long, in a parallel circuit. If the cable is damaged, only the broken resistance stops working but not the whole cable. The thermostat of last generation interfaces with Android and Apple devices, that is why it is possible to adjust all settings and time schedule using an application with internet connection as remote control.

## Advantages

- Only 8.5 mm thickness
- Higher crack-bridging ability
- Uncoupling
- Waterproofing
- Vapour management ducts
- Load distribution
- New constant power cable
- Remote controlled thermost



UNCOUPLING

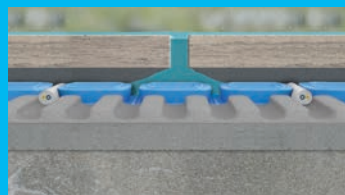

WATERPROOFING



VAPOR AND MOISTURE MANAGEMENT

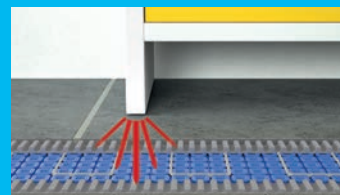

LOAD DISTRIBUTION

## PRODESO® HEAT GRIP MEMBRANE

It is a polyethylene uncoupling and waterproofing membrane, which allows the vapour management, with reliefs to embed and hold the electric heating cable. It has on the lower side a polypropylene non-woven fabric for a better bond to the substrate. The unique design of **PRODESO® HEAT GRIP MEMBRANE** allows:

- Flexible heating zone selection
- Cost and time saving installation
- Uncoupling crack isolation
- Vapor management
- Waterproofing
- Support load distribution
- Small height increase 8,5 mm



## PRODESO® HEAT GRIP CABLE

It is a constant power electric heating cable to be embedded between the reliefs of **PRODESO® HEAT GRIP MEMBRANE**. The cable distance can be 6.2 or 9.3 cm



## PRODESO® HEAT GRIP THERMOSTAT KIT

It is composed of a Wi-Fi digital thermostat, a flush-mounting box, corrugated pipe, two floor temperature sensors and clips to fix the cable.

## LAYING'S SECTION

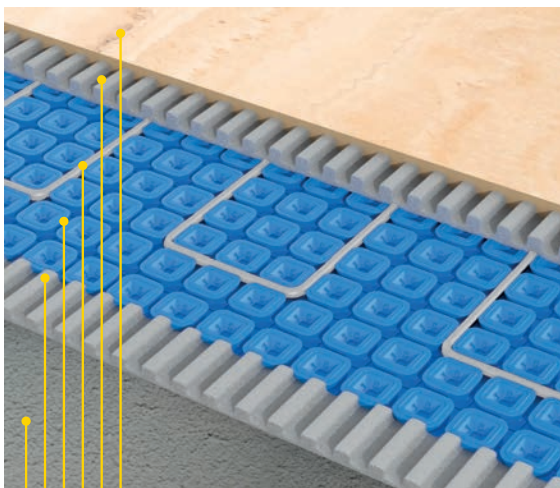

- 1 CERAMIC OR PORCELAIN TILES
- 2 THIN-SET / ADHESIVE
- 3 PRODESO® HEAT GRIP CABLE
- 4 PRODESO® HEAT GRIP MEMBRANE
- 5 THIN-SET / ADHESIVE
- 6 SCREED / PLYWOOD / OSB

## PRODESO® HEAT GRIP MEMBRANE

UNCOUPLING WATERPROOFING MEMBRANE FOR ELECTRIC HEATING - 13/4,5 M<sup>2</sup>

Article	Description	H x L Im	Tot. m <sup>2</sup>
PDESHG 131/E	Prodeso® Heat Grip membrane	(1 ml x 13 ml = 13 m <sup>2</sup> )	13
PDESHG 451/E	Prodeso® Heat Grip membrane	(1 ml x 4,5 ml = 4,5 m <sup>2</sup> )	4,5

## PRODESO® HEAT GRIP CABLE

Article	Cable length Im	Heated surface on the WALL (6,2 cm)	Heated surface on the FLOOR (9,3 cm)	Total Power W
PDHGCB 20	19,80	1,19 m <sup>2</sup>	2,00 m <sup>2</sup>	250 W
PDHGCB 26	25,80	1,55 m <sup>2</sup>	2,50 m <sup>2</sup>	325 W
PDHGCB 31	30,80	1,83 m <sup>2</sup>	3,00 m <sup>2</sup>	385 W
PDHGCB 36	36,00	2,14 m <sup>2</sup>	3,50 m <sup>2</sup>	450 W
PDHGCB 40	40,20	2,38 m <sup>2</sup>	4,00 m <sup>2</sup>	500 W
PDHGCB 46	46,20	2,74 m <sup>2</sup>	4,50 m <sup>2</sup>	575 W
PDHGCB 52	52,20	3,10 m <sup>2</sup>	5,00 m <sup>2</sup>	650 W
PDHGCB 62	61,80	3,69 m <sup>2</sup>	6,00 m <sup>2</sup>	775 W
PDHGCB 72	72,00	4,29 m <sup>2</sup>	7,00 m <sup>2</sup>	900 W
PDHGCB 82	82,20	4,88 m <sup>2</sup>	8,00 m <sup>2</sup>	1025 W
PDHGCB 94	94,20	5,60 m <sup>2</sup>	9,00 m <sup>2</sup>	1175 W
PDHGCB 104	103,80	6,19 m <sup>2</sup>	10,00 m <sup>2</sup>	1300 W
PDHGCB 132	132,00	7,86 m <sup>2</sup>	12,50 m <sup>2</sup>	1650 W
PDHGCB 158	157,80	9,40 m <sup>2</sup>	15,00 m <sup>2</sup>	1975 W

## PRODESO® HEAT GRIP CABLE - 450 M

CONSTANT POWER SILICONE CABLE - DIAMETER 6,5 mm - 230 V

Article	Diameter (mm)	Length Im	Power W/Im
PDHGCBB450	6,5	450 M	12,5W

## PRODESO® HEAT GRIP THERMOSTAT KIT - TOUCH SCREEN - WI-FI KIT DIGITAL THERMOSTAT

Article	Description
PDHTSMWTK	Kit complete with Wi-Fi digital thermostat



## DIGITAL THERMOSTAT

Article	Description
PDHTSMWTT 230	Wi-Fi digital thermostat



## ROLLER FOR CABLE INSTALLATION

Aluminum roller 15 cm long, facilitates and speeds up the insertion of the heating cables between the reliefs of the membranes PRODESO®HEAT e PRODESO® HEAT GRIP.

Article	L cm	Pcs/pack
PSC	15	1



## PROCOFON

Roll of closed-cell polyethylene with adhesive used as edging between the wall and screed or where there are expansion joints.

Article	Thick. x H mm	Im/roll
PEF 550A	5 X 50	25



## PRODESO® HEAT GRIP CABLE KIT

Article	Description
PDHGCK110	1 ml heat shrink sheath + 10 cable lugs
PDHGCK550	5 ml heat shrink sheath + 50 cable lugs



## PRODESO® HEAT GRIP POWER CABLE

Article	Cable length Im
PDHGCBF	2,5



## PRODESO® HEAT CABLE CLIP

Plastic Clip to hold heating cable on PRODESO® HEAT MEMBRANE (40 mm x 5 mm)

Article	Pcs/Pack.
PCBLF	200





# PRODESOS® HEAT SYSTEM

INSTRUCTION VIDEO



**PATENTED**



**PATENTED**

- 002748822
- EP 3,183,505 B1
- US 8,176,694 B2
- US 9,188,348 B2
- US 9,416,979 B2
- US 9,518,746 B2
- US 9,625,163 B2
- US 9,719,265 B2
- US 9,777,931 B2
- US 10,107,505 B2
- US 10,006,644 B2
- US 10,215,423 B2
- US 10,408,469 B2
- US 10,712,020 B2
- US 10,739,016 B2
- Patents Pending

## A World of warmth and comfort in respect with the nature.

Progress Profiles innovative and patented PRODESOS® HEAT SYSTEM for electrical walls and floors heating ensures pleasant warm and comfortable environment with short laying times and at low cost. The system can be used on all kinds of substrate thanks to the membrane uncoupling and waterproofing properties. Temperature and operating times can be controlled from a latest generation thermostat that also guarantees significant savings in energy costs. The system

is quick and easy to install in all conditions and has an overall thickness of only 5.5 mm, far thinner than any alternative system. It is also maintenance free over time. This smart, responsible technology supports the growing demand for sustainable solutions and energy saving while also satisfying the needs of contemporary architecture and evolved home automation. A world of natural, warm wellbeing.

### Advantages



UNCOUPLING / CRACK ISOLATION

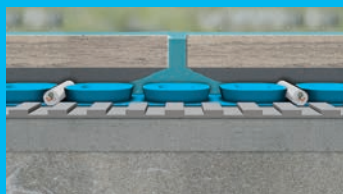

WATERPROOFING



VAPOR AND MOISTURE MANAGEMENT

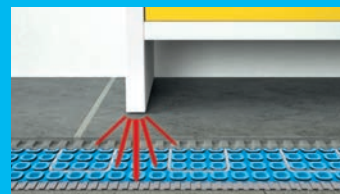

LOAD DISTRIBUTION

## PRODESO® HEAT MEMBRANE

Is a polypropylene uncoupling and waterproofing membrane, with rounded square shaped reliefs. These reliefs form a channel specially designed to embed and hold the **PRODESO® HEAT CABLE**. Product with a new design improvement over the previous version and with many advantageous plus. **PRODESO® HEAT MEMBRANE** unique design allows for:

- Flexible heating zone selection
- Cost and time saving installation
- Uncoupling crack isolation
- Vapor management
- Waterproofing
- Support load distribution
- Small height increase 5,5 mm



## PRODESO® HEAT CABLE

Is a heating cable designed to work in conjunction with **PRODESO® HEAT MEMBRANE**. Cable separation could be 6,2 cm on wall and 9,3 cm on floor.



## PRODESO® HEAT THERMOSTAT KIT

It is composed by a digital or analogic programmable thermostat, flush-mounting box, corrugated pipe and two floor temperature sensors.

## LAYING'S SECTION

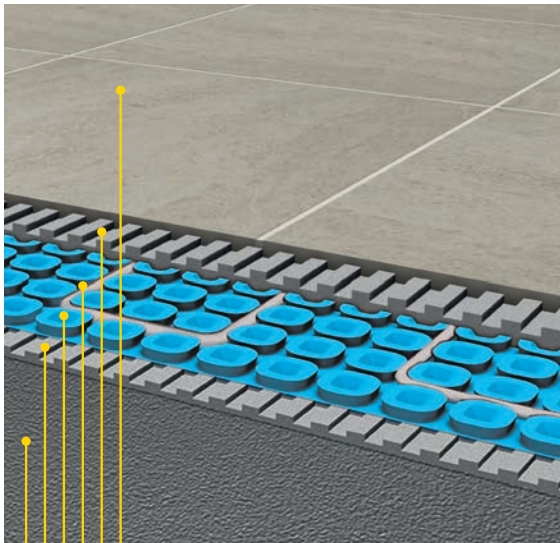

- 1 CERAMIC OR PORCELAIN TILES
- 2 THIN-SET / ADHESIVE
- 3 PRODESO® HEAT CABLE
- 4 PRODESO® HEAT MEMBRANE
- 5 THIN-SET / ADHESIVE
- 6 SCREED / PLYWOOD / OSB

## PRODESO® HEAT UNCOUPLING WATERPROOFING MEMBRANE FOR ELECTRIC HEATING - 15/5 M<sup>2</sup>

Article	Description	Width roll H x L lm	Tot. m <sup>2</sup>
PDESH 151/E	Prodeso® Heat Membrane	(1 ml x 15 ml = 15 m <sup>2</sup> )	15
PDESH 051/E	Prodeso® Heat Membrane	(1 ml x 5 ml = 5 m <sup>2</sup> )	5

## PRODESO® HEAT CABLE

Article	Cable length lm	Heated surface on the WALL (6,2 cm)	Heated surface on the FLOOR (9,3 cm)	Total Power W
PDHCB 12	12,07 ml	0,70 m <sup>2</sup>	1,1 m <sup>2</sup>	150
PDHCB 17	17,66 ml	1,00 m <sup>2</sup>	1,6 m <sup>2</sup>	225
PDHCB 23	23,77 ml	1,40 m <sup>2</sup>	2,2 m <sup>2</sup>	300
PDHCB 29	29,87 ml	1,80 m <sup>2</sup>	2,7 m <sup>2</sup>	375
PDHCB 35	35,97 ml	2,20 m <sup>2</sup>	3,3 m <sup>2</sup>	450
PDHCB 41	41,56 ml	2,50 m <sup>2</sup>	3,8 m <sup>2</sup>	525
PDHCB 47	47,67 ml	2,90 m <sup>2</sup>	4,4 m <sup>2</sup>	600
PDHCB 53	53,77 ml	3,30 m <sup>2</sup>	5,0 m <sup>2</sup>	675
PDHCB 59	59,87 ml	3,70 m <sup>2</sup>	5,5 m <sup>2</sup>	750
PDHCB 71	71,57 ml	4,40 m <sup>2</sup>	6,6 m <sup>2</sup>	900

## PRODESO® HEAT CABLE - 450 M CONSTANT POWER SILICONE CABLE - DIAMETER 4,8 mm - 230 V

Article	Diameter (mm)	Lenght lm	Power W/lm
PDHCB450	4,8	450 M	12,5W

## ROLLER FOR CABLE INSTALLATION

Aluminum roller 15 cm long, facilitates and speeds up the insertion of the heating cables between the reliefs of the membranes.

Article	L cm	Pcs/pack
PSC	15	1



## PROECOFON

Roll of closed-cell polyethylene used as edging between the wall and screed or where there are expansion joints.

Article	Thick. x H mm	lm/roll
PEF 550A	5 X 50	25



## PRODESO® HEAT THERMOSTAT KIT DIGITAL / ANALOGIC

Article	Description
PDHTSKT 230V	Kit complete with digital thermostat - TOUCH SCREEN
PDHTSK 230V	Kit complete with analogic thermostat - NO TOUCH SCREEN



DIGITAL THERMOSTAT KIT



ANALOGIC THERMOSTAT KIT

## THERMOSTAT DIGITAL / ANALOGIC

Articolo	Descrizione
PDHTSMT 230	Digital Thermostat
PDHTSM 230	Analogic Thermostat



DIGITAL ANALOGIC

## PRODESO® HEAT CABLE KIT

Article	Description
PDHGCK110	1 ml heat shrink sheath + 10 cable lugs
PDHGCK550	5 ml heat shrink sheath + 50 cable lugs



## PRODESO® HEAT POWER CABLE

Article	Cable length lm
PDHGCBF	2,5



## PRODESO® HEAT CABLE CLIP

Plastic Clip to hold heating cable on PRODESO® HEAT MEMBRANE (40 mm x 5 mm)

Article	Pcs/Pack.
PCBLF	200





# PRODESO® HEAT KIT SYSTEM

Floor and wall electric heating system kit, composed of 3 pieces: **PRODESO® HEAT MEMBRANE**, **PRODESO® HEAT CABLE** AND **PRODESO® HEAT THERMOSTAT KIT**. The polyethylene membrane, with its uncoupling, waterproofing and vapour management properties, has a thickness of just 5.5 mm.



## PRODESO® HEAT KIT SYSTEM

Wall and floor electric heating system

Article	m <sup>2</sup> membrane	Cable	Power tot W	Thermostat kit	Wall heated surface (with a cable distance of 6,2 cm)	Floor heated surface (with a cable distance of 9,3 cm)
⊕ PDESHK 4	3,2	PDHCB 23	300	1	1,40	2,20
⊕ PDESHK 7	5,6	PDHCB 41	520	1	2,50	3,80
⊕ PDESHK 10	8,0	PDHCB 59	750	1	3,70	5,50

heating cable PDHCB included in the kit

PRODESO® HEAT THERMOSTAT KIT: digital touch screen thermostat, 2 temperature sensors, flush mounting box, flexible corrugated pipe.



PRODESO HEAT MEMBRANE



PRODESO HEAT CABLE



DIGITAL TOUCH



PRODESO HEAT THERMOSTAT KIT



INSTRUCTION VIDEO





Uncoupling and waterproofing membrane in polypropylene with a thickness of 5.5 mm. The membrane is provided on top with pseudo-square reliefs which create channels for fixing the electric heating cable. On the back of the membrane there is a layer of adhesive which guarantees its fixing to the support, clean plywood, OSB, metal or old flooring.

## PRODESO® HEAT STICK MEMBRANE

UNCOUPLING AND WATERPROOFING MEMBRANE

### PRODESO® HEAT STICK MEMBRANE UNCOUPLING WATERPROOFING MEMBRANE FOR ELECTRIC HEATING - 15/5 M²

Article	Description	Width roll LxH Im	Tot. m²
PDESHST 151/E	Prodeso® Heat Stick	(1 ml x 15 ml = 15 m²)	15
PDESHST 051/E	Prodeso® Heat Stick	(1 ml x 5 ml = 5 m²)	5

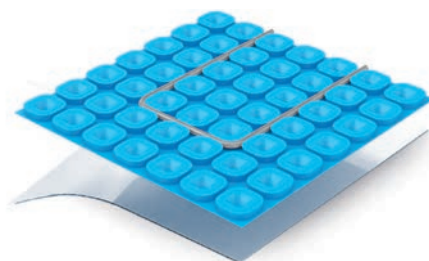

L 5m

L 15m

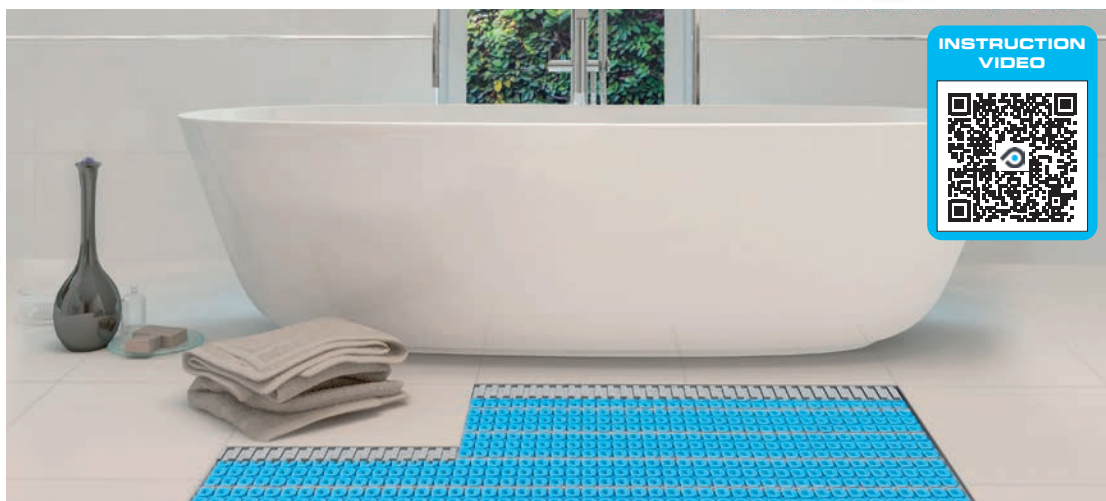

INSTRUCTION VIDEO



PRODESO® ECO / ECO STICK MEMBRANE is an uncoupling and waterproofing membrane in polyethylene with a thickness of 3.5 mm. The membrane is provided on top with dovetail square cavities and on bottom with a layer of adhesive which guarantees its fixing to the support, clean plywood, OSB, metal or old flooring. Thanks to its particular geometry PRODESO® ECO / ECO STICK MEMBRANE transfers loads directly to the support and guarantees the laying of any flooring and the waterproofing even in case of cracked and moisture-sensitive substrates. (\*) available in the self-adhesive version PRODESO® ECO STICK for wood and ceramic substrates.

## PRODESO® ECO / PRODESO® ECO STICK MEMBRANE

UNCOUPLING & WATERPROOFING MEMBRANE

### PRODESO® ECO STICK MEMBRANE UNCOUPLING AND WATERPROOFING SELF-ADHESIVE MEMBRANE - Thickness 3,5 mm

Article	description	Width roll LxH Im
PDESECST 3505/EN	Prodeso® Eco Stick	(1 ml x 5 ml = 5 m²)
PDESECST 3530/EN	Prodeso® Eco Stick	(1 ml x 30 ml = 30 m²)

PRODESO ECO STICK

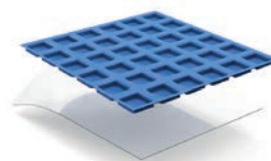

### PRODESO® ECO MEMBRANE UNCOUPLING AND WATERPROOFING MEMBRANE - Thickness 3,5 mm

Article	description	Width roll LxH Im
PDESEC 3505/EN	Prodeso® Eco	(1 ml x 5 ml = 5 m²)
PDESEC 3530/EN	Prodeso® Eco	(1 ml x 30 ml = 30 m²)

PRODESO ECO

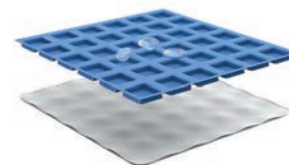

L 30m

L 30m



PRODESO ECO

PRODESO ECO STICK

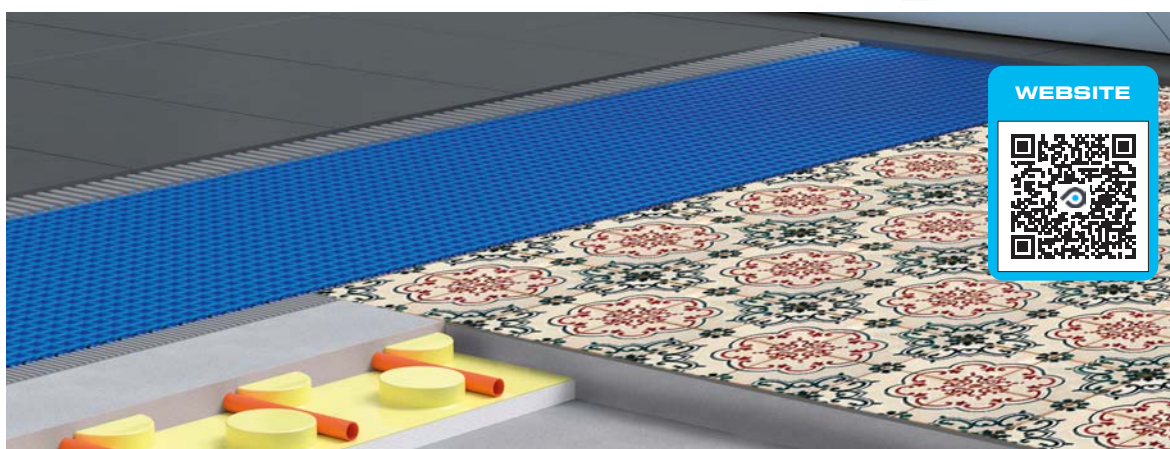

WEBSITE



= News 2021

\* = Production on demand with minimum quantity of 1000 lm Production delay 4/5 weeks. Price to be agreed



# PRODESO® MEMBRANE SYSTEM



**PATENTED**



**PATENTED**  
003368984

**Uncoupling and waterproofing system, particularly good for problematic screeds substrates.**

## PRODESO® MEMBRANE SYSTEM SECTION

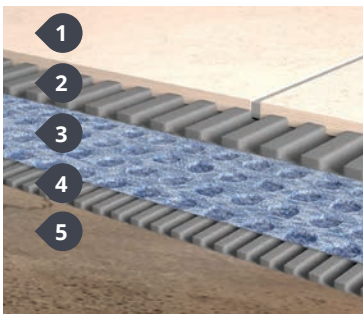

1. Ceramic / Stone or Porcelain Tiles
2. Adhesive
3. PRODESO®
4. Adhesive
5. Screed, Plywood, OSB etc.

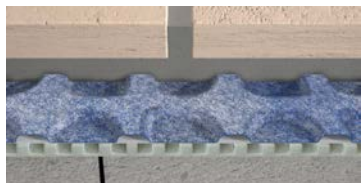

UNCOUPLING

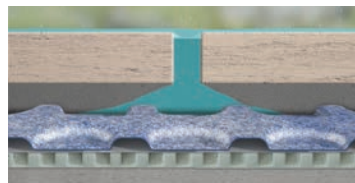

WATERPROOFING

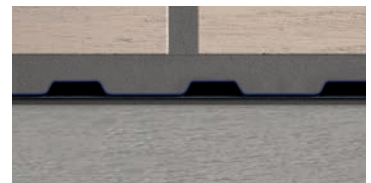

UNCOUPLING

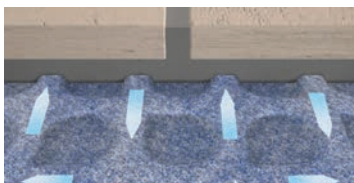

VAPOR AND MOISTURE MANAGEMENT

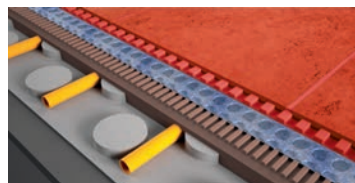

FLOOR HEATING DISTRIBUTION



SUPPORT/LOAD DISTRIBUTION



It is an uncoupling and waterproofing membrane for problematic substrates, balconies, terraces and horizontal surfaces of any size without expansion joints in the screed before the laying of ceramic and natural stone. **PRODESO®** ensures the laying of the flooring and the waterproofing of the substrate also in case of old tiles, on cracked and not perfectly cured substrates, and therefore with possible vapour pressure.

# PRODESO® MEMBRANE

UNCOUPLING & WATERPROOFING  
MEMBRANE

## UNCOUPLING & WATERPROOFING MEMBRANE - Thickness H 3,5 mm

Article	H roll (LM)	L roll (LM)	roll x pallet			
PDES 3530/EN	1	30	8			
PDES 3505/EN	1	5	-			

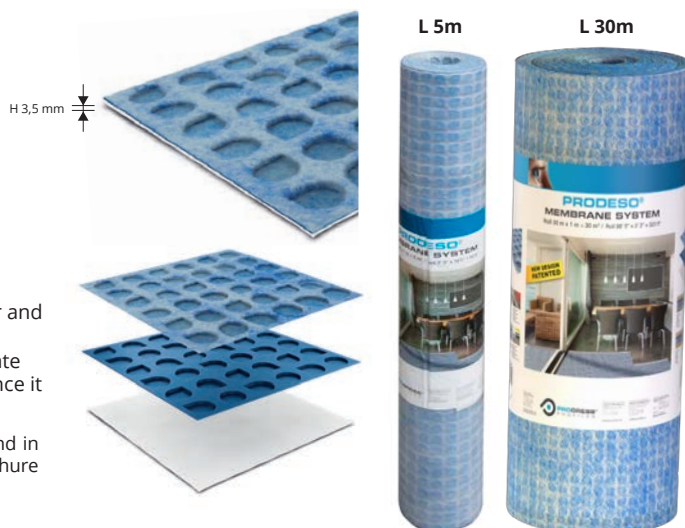

## WHY USE PRODESO® MEMBRANE SYSTEM

**Time Efficient:** PRODESO® Membrane reduces drastically the installation times because from the installation of the membrane up to the laying of flooring you can work without interruption.

**Flexible:** it is suitable for every types of subfloor including very large surfaces both indoor and outdoor.

**Safe:** it is suitable for substrates with cracks as it does not transmit tension of the substrate to the tile coverings and vice versa. It is also suitable on substrates not perfectly cured since it allows the vapour management.

### WARNINGS

Do not lay tiles with a size less than 5 x 5 cm. The technical and application details can be found in the **PRODESO® MEMBRANE SYSTEM** brochure. For other informations not described in the brochure **PRODESO® MEMBRANE SYSTEM**, refer to the technical department.

**PROBAND 150/250** is a waterproofing polyethylene tape with nonwoven polypropylene fabric on both side that guarantees high adhesion to the support.

# PROBAND 150/250

ROLLS IN HDPE AND PP

## ELASTIC ROLLS IN HDPE AND PP - Thickness 0,42 mm

Article	H mm x L lm	Rolls/Pack.			
PRBPE 1507	150 x 7,5	16			
PRBPE 1530	150 x 30	6			
PRBPE 2530	250 x 30	3			

For the indicative consumption of proband koll AB during the installation of the **PROBAND**, consult the technical data sheet of **PROBAND 150/250**

### AREA OF USE

• **Use** - Terraces, balconies and outside surfaces of any dimension, bathrooms, showers, swimming pools and tanks. To realize waterproofing joints between floor and wall and along two adjacent rolls of **PROFOIL**, **PRODESO® MEMBRANE SYSTEM** and **PRODESO® HEAT/GRIP SYSTEM**

• **Don't use** - On bituminous coverings, over thermal-insulating layer and lightweight screed. With adhesives containing solvents.

### WARNINGS

Store in a cool and dry place avoiding direct sunlight and sources of heat. Read the data sheet before applying; in case of special applications call the technical department



## RECOMMENDED ADHESIVES FOR THE LAYING OF PRODESO® MEMBRANE

 <b>KERAFLEX EASY</b> <b>ULTRALITE S1</b> <b>KERAFLEX MAXI S1</b>	 <b>F.55 CERMONO PLUS</b> <b>F.55 CERFIX</b> <b>F.55 CERMONO RAPIDO</b>	 <b>EXTRA 30 MAXI</b> <b>ADEFLEX GREEN S1</b> <b>EXTRA 30 POWER</b>	 <b>H40 NO LIMITS</b> <b>H40 REVOLUTION</b> <b>H40 EXTREME</b>	 <b>SUPERFLEX K77</b> <b>POWERFLEX K50</b> <b>LITOSTONE K99</b>	 <b>FLEXBOND C2S1</b> <b>FLEXBOND LIGHT C2S1</b> <b>WETBOND RAPID C2F</b>	 <b>GRIGOKOLL TEX</b> <b>GRIGOKOLL MAX</b> <b>GRIGOKOLL VELOX</b>
 <b>CERAM 255 STARFLEX</b> <b>CERAM 255 EASY S1</b> <b>CERAM 270 MULTIFLOW</b>	 <b>ULTRAGRES 440</b> <b>ULTRAGRES FLEX</b> <b>ULTRAGRES FAST</b>	 <b>PERICOL R-FLEX</b> <b>PERICOL EXTRA FLEX</b> <b>PERICOL FLEX</b>	 <b>335 MAXI S</b> <b>335 SUPER FLEX</b> <b>325 RAPID FL</b>	 <b>ARDEX X 78</b> <b>ARDEX X 90 OUTDOOR</b> <b>ARDEX AF 495</b>	 <b>MUREFLEX MFK 45</b> <b>ADESIVO FBS 75</b> <b>MAXIMO M 41</b>	 <b>RT UNIVERSAL</b> <b>RT HI TECH</b> <b>RT RAPID FLEX</b>
 <b>SEYFLEX S1</b> <b>SEYULTRA T</b> <b>TIXOSEY</b>	 <b>KRISTAL C2TE</b> <b>EXTRA C2S1</b>	 <b>AZ 59</b> <b>RAPID MAXI</b> <b>SPECIAL ONE</b>	 <b>CERMIPLUS 2.0</b> <b>CERMIPLUS XL FLEX 2.0</b>	 <b>FORTEM</b> <b>MAXIM</b>	 <b>BENFERFLEX+S1</b> <b>BENFERFLEX C2</b> <b>BENFERFLEX + FAST-S1</b>	



# PREFORMED CORNERS

Internal and external preformed corners in polyethylene provided on both side with nonwoven polypropylene fabric that guarantees its adhesion to the support.

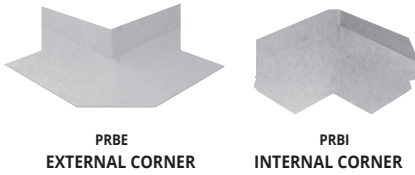

**PREFORMED CORNERS IN HDPE AND PP**  
Thickness **0,42 mm** - Pack **10 Pcs**

Article	H x L mm			
PRBI	60 x 120			
PRBE	60 x 120			

### AREA OF USE

- **Use** - Terraces, balconies and outside surfaces of any dimension, bathrooms, showers, swimming pools and tanks. To realize waterproofing joints between floor and wall and along two adjacent rolls of **PROFOIL**, **PRODES® MEMBRANE SYSTEM** and **PRODES® HEAT/GRIP SYSTEM**
- **Don't use** - On bituminous coverings, over thermal-insulating layer and lightweight screed. With adhesives containing solvents. adhesive.

# PROBAND BU

BUTYLE TAPE

**PROBAND BU** is an adhesive tape in butyle provided on one side with non-woven polypropylene that guarantees high adhesion. use for the Realization of perimeter junctions in case of bituminous coverings, PVC, wood, polycarbonate, glass, plastic and metal on balconies, terraces and external surfaces of any size.



**BUTYL ADHESIVE TAPE** - Thickness **H 1 mm**  
- rolls **15 ml** - Pack **2 Pcs.**

Article	H roll (mm)			
PRBBU 7515	75			

**WARNINGS: Don't use** - On dirty, incoherent and wet surfaces.

# PROBAND KOLL

SINGLE-COMPONENT HYDROPHOBIC ADHESIVE

**PROBAND KOLL** is a single-component hygro-hardener adhesive for the sealing of **PROBAND 150/250** on **PRODES® MEMBRANE**.



**FAST SETTING SINGLE-COMPONENT HYDROPHOBIC ADHESIVE**  
Pack of **6 Kg** pack per pallet = **100 Pcs** per pallet **600 Kg.**

Article	Pack. Kg.			
PRBKL	6			

For the indicative consumption of proband koll during the installation of the **PROBAND**, consult the technical data sheet of **PROBAND 150/250**

### AREA OF USE

- **Use** - For the sealing of the tape **PROBAND 150/250** with **PRODES® MEMBRANE** and **PRODES® HEAT/GRIP MEMBRANE** on balconies, terraces, bathrooms, kitchens, saunas and external surfaces of any size.
- **Don't use** - On bituminous coverings, to glue tiles and to waterproof cement based support. Do not use outside with **PRODES® HEAT/GRIP MEMBRANE**

# PROBAND KOLL AB

BICOMPONENT HYDROPHOBIC ADHESIVE

**PROBAND KOLL AB** is a bicomponent hydrophobic adhesive for the sealing of **PROBAND 150/250** on **PRODES® MEMBRANE** and **PRODES® HEAT/GRIP MEMBRANE**.



**FAST SETTING BICOMPONENT HYDROPHOBIC ADHESIVE**  
Pack of **15 Kg** - pack/pallet = **27 Pcs** - Kg/pallet **405 Kg.**

Article	Pack. Kg.			
PRBKLAB	15			

For the indicative consumption of proband koll AB during the installation of the **PROBAND**, consult the technical data sheet of **PROBAND 150/250**

### AREA OF USE

- **use** - Balconies, terraces , bathrooms, kitchens, saunas and external surfaces of any size.
- **Don't use** - as waterproofing sheet, to glue tiles and **PRODES®** family membranes, **PROFOIL** and **PROFOIL PANEL**.

# PROMEMBRANE KOLL

CEMENTITIOUS ADHESIVE

**PROMEMBRANE KOLL** is a C2ES1 class cementitious adhesive, with high workability and prolonged adjustability, specially designed to bond all the membranes of the "PRODES®" family, even overlapping and on floor heating systems and the **PROFOIL** membrane.



**PROMEMBRANE KOLL CEMENTITIOUS ADHESIVE**  
pack/pallet = **25 PCS.** - **625 KG** per pallet

Article	Kg./Pack			
PRMKL	25			

Sold exclusively by the pallet.

**WARNINGS: Do not use** **PROMEMBRANE KOLL** for bonding natural or recomposed stone sensitive to moisture. Consult the technical data sheet before application; in case of particular applications, it's advisable to consult the technical department.

# PROBAND FIX

MOISTURE-CURE SEALANT

**PROBAND FIX** is a moisture-cure sealant with high adhesion and elasticity. It guarantees the adhesion of **PROBAND 150/250** with aluminium frames, plastic and metal and between adjacent sheets of **PROFOIL**. Don't use On bitumen membranes. To seal proband with **PRODES®**.

**MOISTURE-CURE SEALANT**  
pack. of **12** cartridges - **B** (white) - **G** (grey)

Article	Cartridge lm			
PRBFXB	290			
PRBFXG	290			



**GUN FOR MOISTURE-CURE SEALANT CARTRIDGE**

Article	Pc/Pack			
PRBFXGUN	1			



**MOISTURE-CURE SEALANT CARTRIDGE**

pack. of **12** cartridges - **B** (white) - **G** (grey)

Articolo	Cartridge lm			
PRBFXUB	600			
PRBFXUG	600			



**PROSHOWER LATERAL AND VERTICAL DRAIN KIT** are 2 central drain systems with lateral or vertical outflow equipped with a siphon, grate support, stainless steel grate, butyl double-sided ring for the fixing of the waterproof section, waterproof section and a protection cap with template function too that allows the correct positioning of the butyl ring and the waterproof section. LATERAL AND VERTICAL DRAIN KIT ensure a correct flow of rainwater.

## PROSHOWER DRAIN KIT

LATERAL AND VERTICAL DRAINS

Article	Description	Pc/Pack.
PSHLDK	PROSHOWER DRAIN LATERAL KIT	1
PSHVDK	PROSHOWER DRAIN VERTICAL KIT	1

### AREA OF USE

- **Use** - Balconies, terraces, outdoor surfaces of any size, kitchens and showers.
- **Don't use** - In environments subject to heavy traffic and where washing with acidic and strong alkaline substances is foreseen.

### WARNINGS

After the drain installation, apply the protective cap. Before applying the butyl double-sided adhesive ring on the flange of the drain, thoroughly clean the flange of any dirt residue that may compromise its adhesion. Apply the butyl double-sided adhesive ring and the waterproofing section during the application of the waterproofing system.



PROSHOWER DRAIN LATERAL KIT PSHLDK

PROSHOWER DRAIN VERTICAL KIT PSHVDK

**PRODRIP** is a perimeter drain in ASA (Modified ABS) equipped with wall-floor junction. The junction is covered with non-woven polypropylene to ensure sealing with the used waterproofing system.

## PRODRIP

PERIMETER DRAIN

### PERIMETER DRAIN

pack. per pallet = 192

Article	Pcs/Pack.
PDRP	4

### AREA OF USE

- **Use** - To realise perimeter drains on balconies, terraces and outside horizontal surfaces of any size.
- **Don't use** - With bituminous waterproofing and as vertical drain.

### WARNINGS

Do not heat with direct flames and do not use adhesive with solvents. Consult the data sheet prior to application in the case of special applications, we recommend that you consult the technical department.

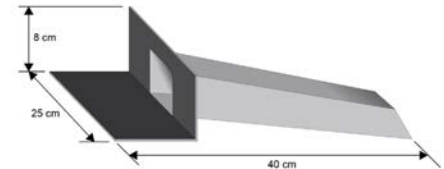

It is a membrane in high density polyethylene. It is covered on top with a polypropylene spunbond and on the back with a non-woven fabric in polypropylene. Both of them are thermo-welded to the polyethylene sheet to guarantee the adhesion of the membrane with the adhesive. **PRODESO® SOUND** is an uncoupling and soundproof membrane, with a thickness of 2,3 mm, which does not require any expansion joints before tiling with ceramic or natural stone. **PRODESO® SOUND** guarantees the laying of any flooring and the soundproofing up to 17dB in any indoor environment, even in the case of problematic supports and old tiles.

## PRODESO® SOUND

UNCOUPLING AND SOUNDPROOF MEMBRANE

ROOL - Thickness 2,3 mm

Article	Roll H x L Im	rolls / pallet
PDSND 30	1 x 20	12

### AREA OF USE

- **Use** - Uncoupling and soundproof membrane also for cracked screeds. It can be laid on cement and gypsum based screed, old ceramic, natural stone floorings, concrete and wood structure. Very resistant to saline solutions, acids and alkalis, alcohol and oils. In case of particular products, contact our technical department.
- **Don't use** - On lightweight screeds not suitable for the laying of flooring. Do not lay with adhesives containing solvents.

### WARNINGS

For the laying of PRODESO® SOUND use a C2S1 cement based adhesive. Tile immediately after the membrane laying to avoid damages. If it is not possible to tile immediately, the membrane must be protected using running boards. Do not use PRODESO® SOUND on substrates subject to continuous rising moisture. For information not included in the Technical Details, please contact our technical department.

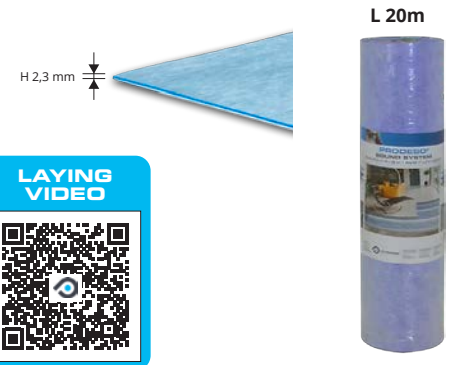

**PROECOFON** is a roll of closed-cell polyethylene used as edging between the wall and screed or where there are expansion joints. It should be used in all floor-laying work to ensure long life of the floor.

## PROECOFON

EXPANDED POLYETHYLENE CLOSED - CELL WITH ADHESIVE

### CLOSED-CELL EXPANDED POLYETHYLENE WITH ADHESIVE

Article	Thick. x H mm	lm/roll
PEF 550A	5 X 50	25
PEF 5100A	5 X 100	100

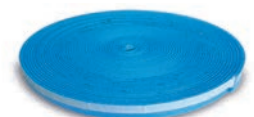

Adhesive junction tape for the membrane PRODESO® SOUND

### PRODESO® SOUND TAPE - height 50 mm

Article	lm/roll	Pc/Pack	Pc/box
PDSNDTP 550	50	6	36

## PRODESO® SOUND TAPE





# PROFOIL PRO

ROLLS IN HDPE AND PP

**PROFOIL** is a waterproofing polyethylene membrane with nonwoven polypropylene fabric on both side that guarantees high adhesion to the support.

**PROFOIL PRO** is a waterproofing elastic polyethylene membrane with nonwoven polypropylene fabric on both side that guarantees high adhesion to the support.

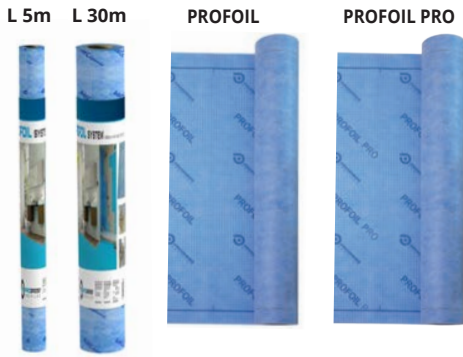

**PROFOIL - ROLLS IN HDPE AND PP - Thickness 0,42 mm**

Article	Width roll H x L Im	total m <sup>2</sup>	Rolls/pallet		
PFLO 0430	1 x 30	30	40		
PFLO 0405	1 x 5	5	154		

**PROFOIL PRO - ELASTIC ROLLS IN HDPE AND PP - Thickness 0,42 mm**

Article	Width roll H x L Im	total m <sup>2</sup>	Rolls/pallet		
PFLOPR 0430	1 x 30	30	40		



### AREAS OF USE

• **Use.** Waterproofing of substrates and vertical structures before the laying of ceramic in areas subject to occasional contact with water like bathrooms and kitchens, saunas and Turkish baths. **PROFOIL PRO** can also be used in environments with permanent contact with water like swimming pools and tanks. • **Don't use.** On bituminous coverings, over insulating panels and lightweight screed.

### WARNINGS

Store in a cool and dry place avoiding direct sunlight and sources of heat. Read the data sheet before applying; in case of special applications please call the technical department.

# PROFOIL PASTE

WATERPROOFING ELASTIC MEMBRANE



**PROFOIL PASTE** is a ready to use thin-layer waterproofing elastic membrane with low emissions of volatile organic compounds.

**WATERPROOFING ELASTIC MEMBRANE**

Article	Kg./Bucket	Bucket/ Pallet			
PFLOPST 04	4	64			
PFLOPST 10	10	36			

### WARNINGS

**Don't use.** For external application, on wet surfaces or substrates subject to moisture rising, in environments where water is always present, pools and tanks. Store in a cool and dry place avoiding direct sunlight and sources of heat. Read the data sheet before applying; in case of special applications please call the technical department.

# PROBAND 150/250

ELASTIC ROLLS IN HDPE AND PP



**PROBAND 150/250** is a waterproofing polyethylene tape with nonwoven polypropylene fabric on both side that guarantees high adhesion to the support.

**ELASTIC ROLLS IN HDPE AND PP - Thickness 0,42 mm**

Article	Roll width H mm x L Im	Rolls/ Pack.			
PRBPE 1507	150 x 7,5	16			
PRBPE 1530	150 x 30	6			
PRBPE 2530	250 x 30	3			

### AREA OF USE

• **Use** - Terraces, balconies and outside surfaces of any dimension, bathrooms, showers, swimming pools and tanks. To realize waterproofing joints between floor and wall and along two adjacent rolls of **PROFOIL**, **PRODESO® MEMBRANE SYSTEM** and **PRODESO® HEAT/GRIP SYSTEM**. • **Don't use** - On bituminous coverings, over thermal-insulating layer and lightweight screed. With adhesives containing solvents.

# PREFORMED CORNERS and PIPE COLLAR

Internal and external preformed corners and pipe collar in polyethylene provided on both side with nonwoven polypropylene fabric that guarantees its adhesion to the support. Use on Terraces, balconies and outside surfaces of any dimension, bathrooms, showers, swimming pools and tanks. To realize waterproofing joints between floor and wall and along two adjacent rolls of **PROFOIL**, **PRODESO® MEMBRANE SYSTEM** and **PRODESO® HEAT/GRIP SYSTEM**.

**PREFORMED CORNERS AND PIPE COLLAR IN HDPE AND PP**

Thickness 0,42 mm

Article	H x L mm			
PRBI	60 x 120			
PRBE	60 x 120			
PRBT	125 x 125			

### WARNINGS

• **Don't use** - On bituminous coverings, over thermal-insulating layer and lightweight screed. With adhesives containing solvents. adhesive.

# PRODRAIN 10

MEMBRANA DRENANTE

**DRAINAGE MEMBRANE**

Thickness H 10 mm - Total 12,0 m<sup>2</sup> - 6 ROLLS PER PALLET = 72 m<sup>2</sup>

Article	H roll (MT)	L roll (MT)	roll x pallet		
PDRI 10	0,96	12,5	6		

### AREAS OF USE

• **Use.** Outside on concrete sloping suitably waterproofed such as terraces, balconies and pavements and in contact with waterproofed vertical structures such as foundation walls. Highly resistant to saline solutions, acid and alkaline, alcohol and oils. In case of special products consult the technical department.

• **Don't use.** On concrete waterproofed without adequate slope to the drained water runoff. As soundproof and thermal-insulating layer.

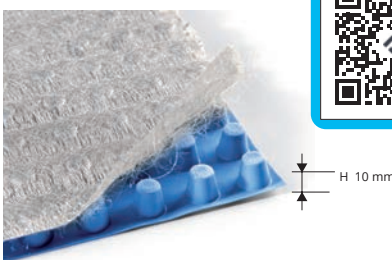

**PROFOIL PANEL** are high density extruded polystyrene panels covered on both sides with a steam- and waterproofing membrane. The membrane is waterproofing and the adhesive to fix them reinforces the panels for a quick and inexpensive laying.

## PROFOIL PANEL

HIGH DENSITY EXTRUDED POLYSTYRENE PANEL

**PROFOIL PANEL 2700 mm - high density extruded polystyrene**  
915 mm x 2700 mm = 2,470 m<sup>2</sup>

Article	H mm	Pcs/pallet	Mq/pallet			
PFLPAN927	9,50	80	197,60			
PFLPAN1327	12,70	60	148,20			
PFLPAN1627	15,90	50	123,50			
PFLPAN2527	25,00	30	74,10			
PFLPAN3827	38,10	20	49,40			
PFLPAN5027	50,80	15	37,05			

PROFOIL PANEL in 1524 mm is available only in small quantity.  
Please contact the office for availability.



PFLPAN...

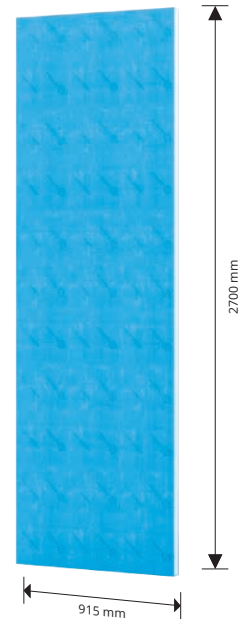

THICKNESS PROFOIL PANEL

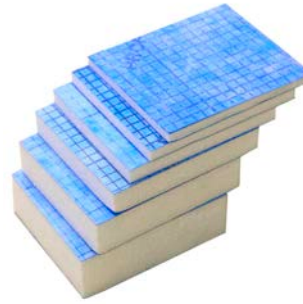
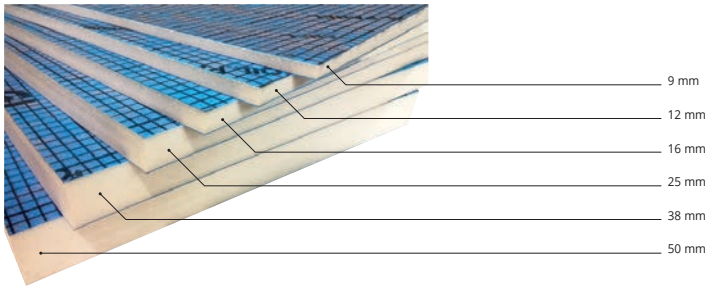

## PROFOIL AND PROBAND DOWELS, WASHERS, SCREWS

STAINLESS STEEL/ZINC-COATED METAL/GLASS FIBER NET



**PROFOIL DOWELS - ZINC-COATED METAL - pack. 250 Pc**

Article	L mm		
TZPFP 110	100		
TZPFP 140	140		
TZPFP 170	170		
TZPFP 200	200		



**PROFOIL DOWELS - STAINLESS STEEL - pack. 250 Pc**

Article	L mm		
TIPFP 110	110		
TIPFP 140	140		
TIPFP 170	170		
TIPFP 200	200		
TIPFP 250	250		



**PROFOIL WASHERS (ZINC-COATED METAL) - pack. 100 Pc**

Article	Pcs/Pack.	ø mm	
RFPPF 36	100	35	

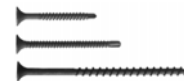

**PROFOIL SCREWS (ZINC-COATED METAL)**

Article	Pcs/Pack.	L mm	
VACPFP 35	1000	35	
VACPFP 55	1000	45	
VACPFP 80	1000	80	

**PRO GOBOARD PANEL** highdensity polyisocyanurate foam panel, covered on both sides with a fibre-glass reinforced cement-based waterproof coating to allow the laying of tiles. The panels, tested for a resistance long duration, are available in thickness of 6,25 / 12,5 / 25 and 50 mm, size of 92 x 152 cm and 122 x 244 cm and can be used on floors, false ceilings, walls, showers and ceilings.

## PRO GOBOARD PANEL

HIGH DENSITY POLYISOCYANURATE FOAM PANEL

**PRO GOBOARD PANEL - highdensity polyisocyanurate foam**

Article	Description	Pcs/pallet	m <sup>2</sup> /pallet	/m <sup>2</sup>		
PGOBOR06	PRO GOBOARD H 6,25 mm - 92 cm x 152 cm - 1,40 m <sup>2</sup>	75	105			
PGOBOR125	PRO GOBOARD H 12,5 mm - 92 cm x 152 cm - 1,40 m <sup>2</sup>	60	84			
PGOBOR25	PRO GOBOARD H 25 mm - 122 cm x 244 cm - 2,98 m <sup>2</sup>	30	89,4			
PGOBOR50	PRO GOBOARD H 50 mm - 122 cm x 244 cm - 2,98 m <sup>2</sup>	15	44,70			

PGOBOR...

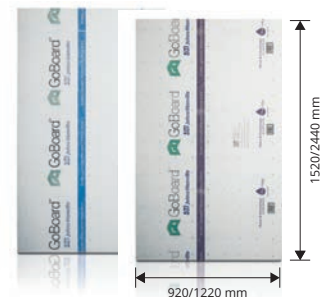

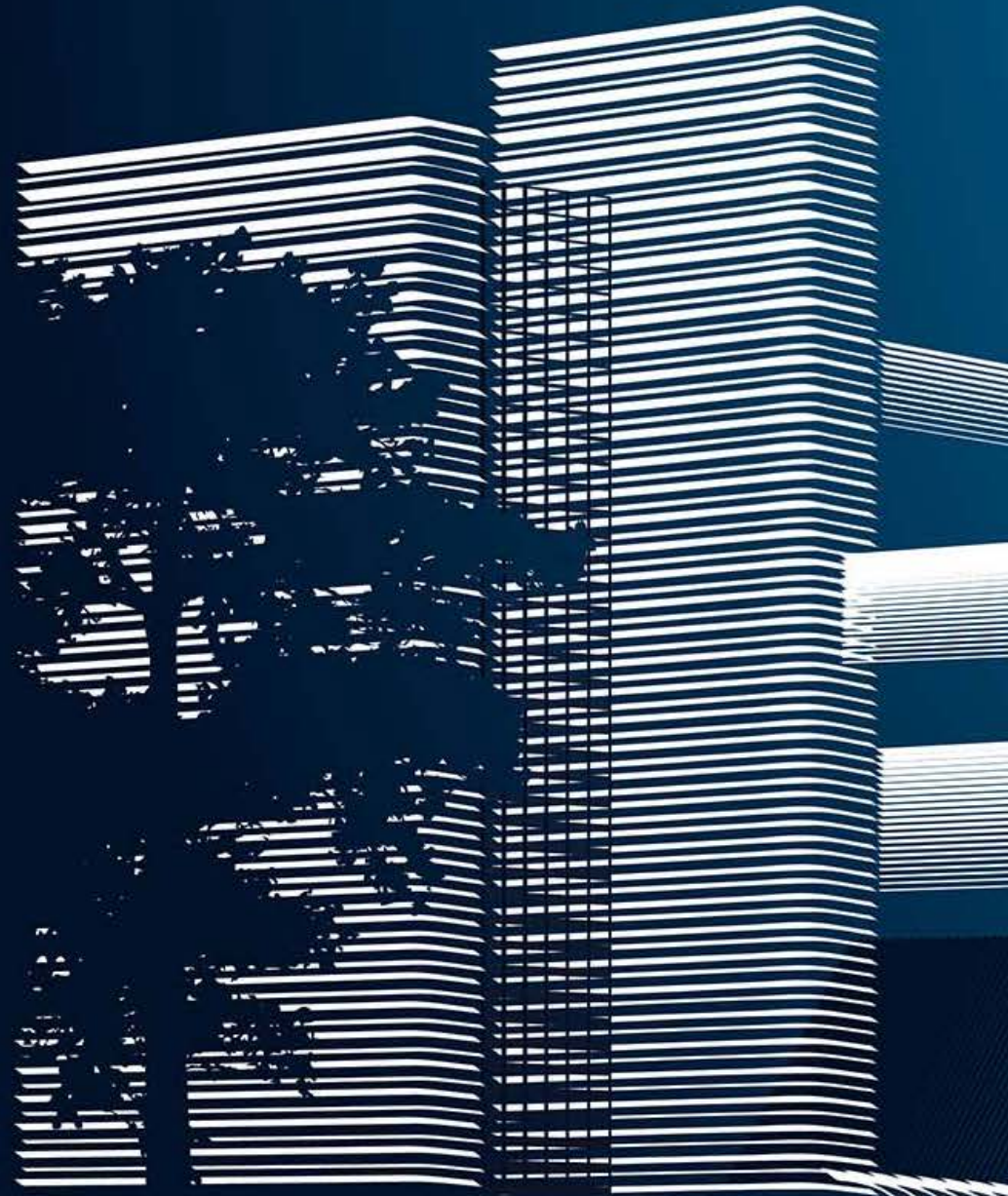

An interpretation of:  
**Kaufmann "Fallingwater" House, Frank Ll. Wright, Pennsylvania (USA), 1939**





PROFILES & SYSTEMS

SHOWER AND DRAINAGE SYSTEMS

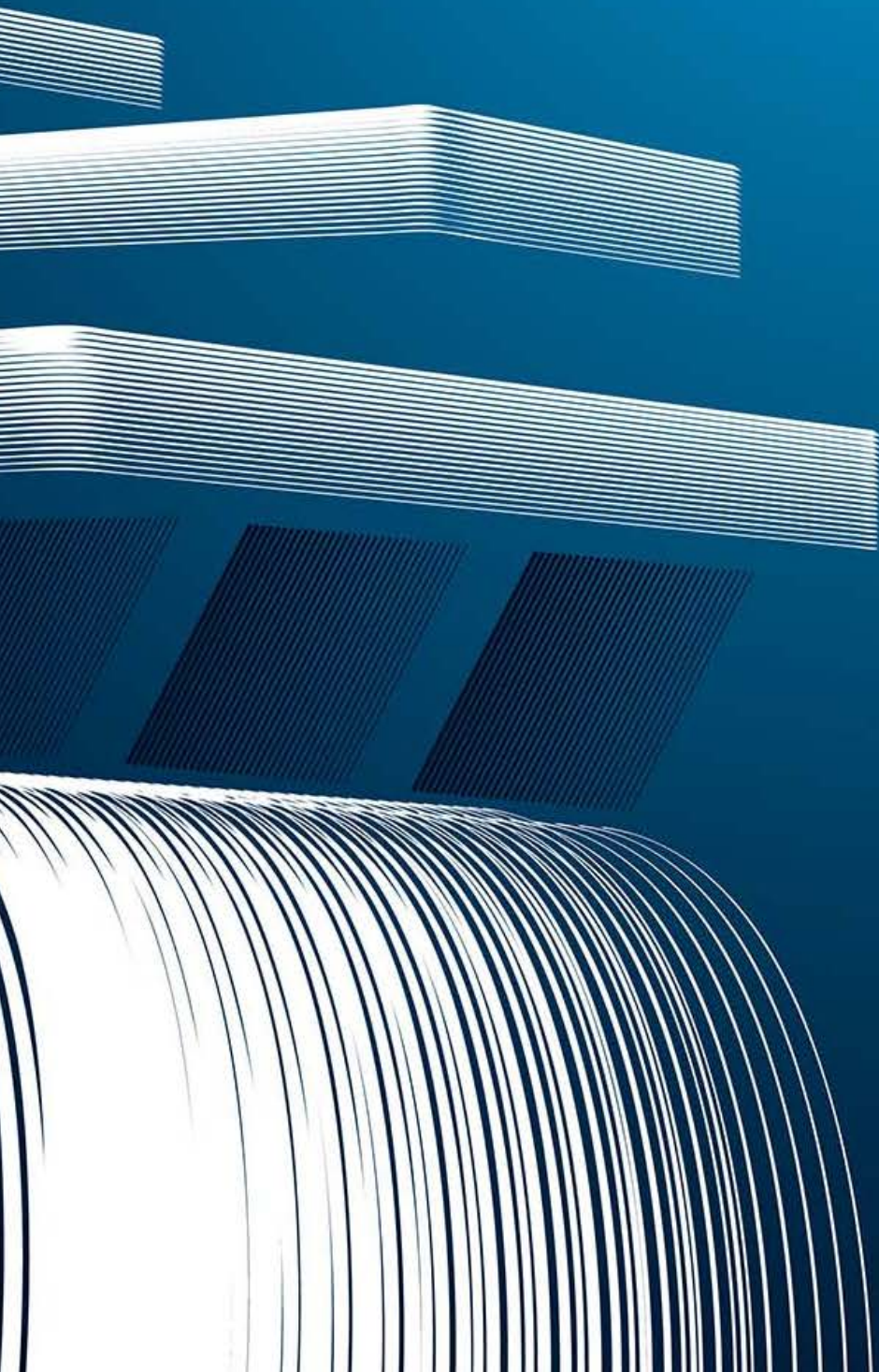



# PROSHOWER LINEAR KIT SYSTEM

PROSHOWER LINEAR KIT SYSTEM is an innovative solution, which combines functionality and design to answer to all requirements of the shower.



Article	Description	Pc/Pack.
PSHPANEK	PROSHOWER LINEAR KIT BASE	1

Article	Kit components	Pc/Pack.
PSHPAN...	PROSHOWER PANEL in moulded polystyrene 120x120 cm with glued Profoil	1
PRBFXB	PROBAND FIX white	2
PRBPE 1507	ROLL PROBAND 150 - 7,5 lm	1
PFLO 0405	PROFOIL ROLL - 5 lm	1
PIAA 40212	ALUMINUM PROFILES (screed leveling profile) length 120 cm	2
PRSPD 10	PVC TOWEL	1



PROSHOWER PANEL LINEAR  
PSHPAN

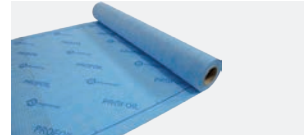

PROFOIL  
PFLO 0405



PROBAND 150  
PRBPE 1507



PROBAND FIX  
PRBFXB



PVC TOWEL  
PRSPD 10



ALUMINUM PROFILES  
PIAA 40212

PROSHOWER PANEL EXTENSION  
EXEMPLES OF LAYING

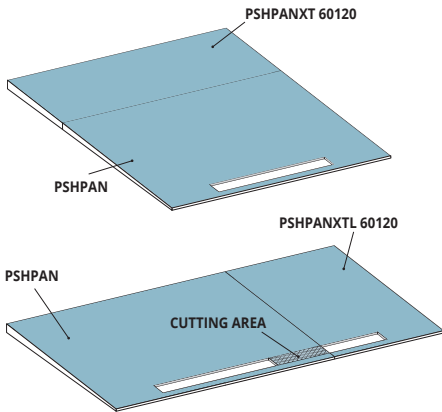

Article	Description	Pc/Pack.
PSHPAN	Proshower panel in moulded polystyrene 120x120 cm with glued Profoil	1

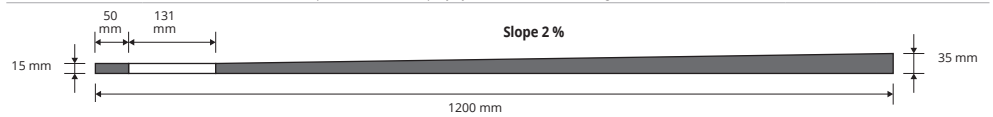

Article	Description	Pc/Pack.
PSHPANXT 60120	PROSHOWER PANEL EXTENSION 120x60 cm for PROSHOWER PANEL LINEAR - Slope 2%	1
PSHPANXTL 60120	LATERAL PROSHOWER PANEL EXTENSION 60x120 cm for PROSHOWER PANEL LINEAR - Slope 2%	1

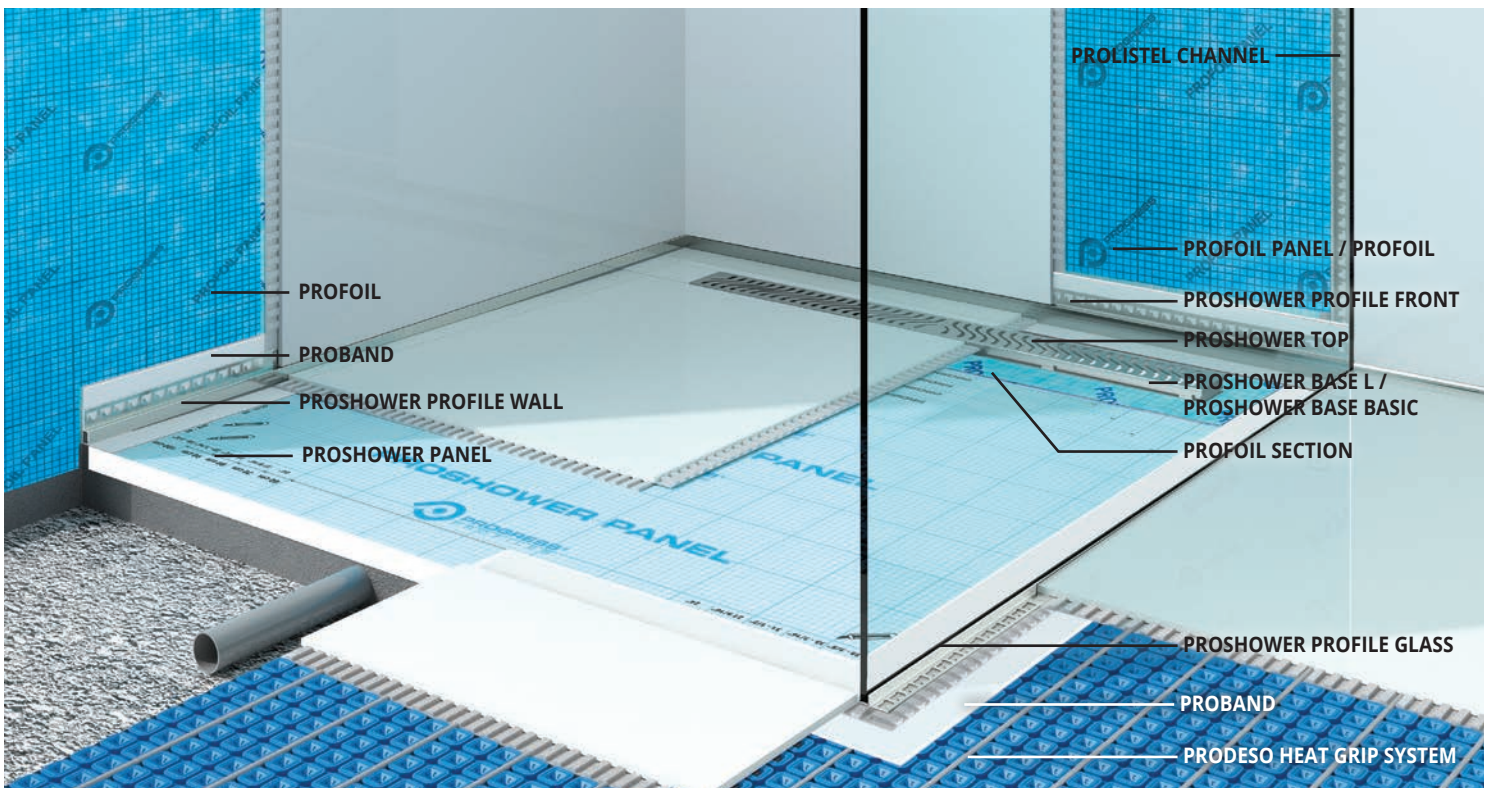

**PROSHOWER BASE L** is a channel body in stainless steel AISI 304/1.4301 - V2A steel for the realisation of floor-level shower. The body channel, with an overall height of 85 mm, is completed by 6 different grids in stainless steel. **PROSHOWER BASE L** undergoes electro-polishing and subsequent passivation, which guarantees excellent resistance in any environment. Its low thickness combined with the fully adjustable siphon, the modularity and the high number of grids make it a much sought-after solution.

## PROSHOWER BASE L

SUPER POLISHED STAINLESS STEEL  
AISI 304/1.4301-V2A



\* L 30 cm

DUCT BODY MADE OF AISI 304 STAINLESS STEEL

Article	Description	Pc/Pack.
PSHWDL 30	PROSHOWER BASE L-ACC-L 30 x 8 cm	1
PSHWDL 70	PROSHOWER BASE L-ACC-L 70 x 8 cm	1
PSHWDL 80	PROSHOWER BASE L-ACC-L 80 x 8 cm	1
PSHWDL 90	PROSHOWER BASE L-ACC-L 90 x 8 cm	1
PSHWDL 100	PROSHOWER BASE L-ACC-L 100 x 8 cm	1
PSHWDL 120	PROSHOWER BASE L-ACC-L 120 x 8 cm	1

PSHWDL 30 / 70 / 80 / 90 / 100 / 120

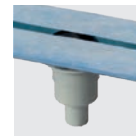
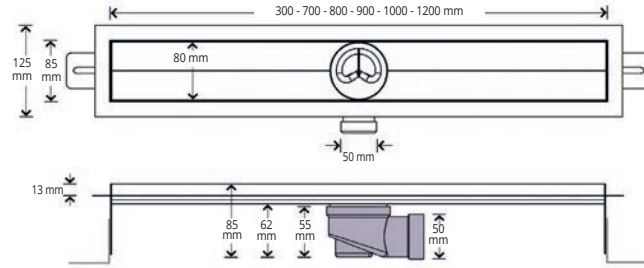

### UPON REQUEST

PROSHOWER BASE L with vertical siphon complete of installed Profoil membrane (code ref. PSHWDVS...). Drain Ø 50 mm.

**PROSHOWER BASE BASIC** is a water collecting duct system in polypropylene for floor showers, available in several lengths and grids.

## PROSHOWER BASE BASIC

GREY POLYPROPYLENE



GREY POLYPROPYLENE DUCT BODY

Article	Description	Pc/Pack.
PSHWBB 60	PROSHOWER BASE BASIC - 60 x 8 cm PP	1
PSHWBB 70	PROSHOWER BASE BASIC - 70 x 8 cm PP	1
PSHWBB 80	PROSHOWER BASE BASIC - 80 x 8 cm PP	1
PSHWBB 90	PROSHOWER BASE BASIC - 90 x 8 cm PP	1

PSHWBB 60 / 70 / 80 / 90

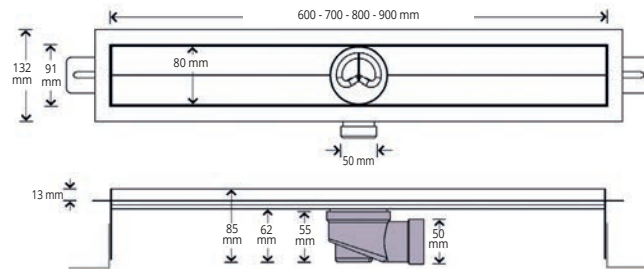

### UPON REQUEST

PROSHOWER BASE BASIC with vertical siphon complete of installed Profoil membrane (code ref. PSHWBVS...). Drain Ø 50 mm.

## PROFOIL SECTION

HDPE E PP GUAINA

PROFOIL SECTION AND DOUBLE SIDED TAPE 3 lm

Article	L	Pc/Pack.
PSHANT 30	30 cm	1
PSHANT 60	60 cm	1
PSHANT 70	70 cm	1
PSHANT 80	80 cm	1
PSHANT 90	90 cm	1
PSHANT 100	100 cm	1
PSHANT 120	120 cm	1



3 m

PROFOIL SECTION AND DOUBLE SIDED TAPE

## PROSHOWER TOP

SUPER-POLISHED STAINLESS STEEL AISI 304 / 1.4301 - V2A

## PROSHOWER TILE - tileable

PSHWT 30/60/70/80/90/100/120



## PROSHOWER LINE

PSHWL 60/70/80/90/100/120



## PROSHOWER DESIGN

PSHWD 30/60/70/80/90/100/120



## PROSHOWER STRIPS

PSHWST 60/70/80/90/100/120

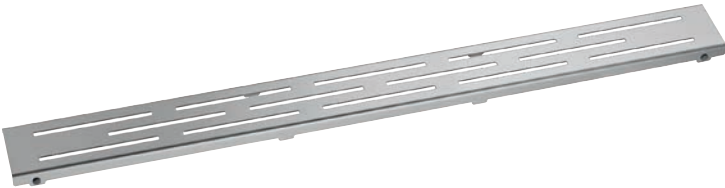

## PROSHOWER GRILL

PSHWGR 60/70/80/90/100/120



## PROSHOWER SQUARE

PSHWSQ 60/70/80/90/100/120



PROSHOWER TILE - SUPER-POLISHED STAINLESS STEEL AISI 304 / 1.4301 - V2A - Pack. 1 Pc

Article	Lenght cm	Width cm
PSHWT 30*	30	8
PSHWT 60**	60	8
PSHWT 70	70	8
PSHWT 80	80	8
PSHWT 90	90	8
PSHWT 100*	100	8
PSHWT 120*	120	8

\*PSHWT 30,100,120 Provided only combined with Proshower Base L.

\*\*PSHWT 60 Provided only combined with Proshower Base Basic.

PROSHOWER LINE - SUPER-POLISHED STAINLESS STEEL AISI 304 / 1.4301 - V2A - Pack. 1 Pc

Article	Lenght cm	Width cm
PSHWL 60**	60	8
PSHWL 70	70	8
PSHWL 80	80	8
PSHWL 90	90	8
PSHWL 100*	100	8
PSHWL 120*	120	8

\*PSHWL 100,120 Provided only combined with Proshower Base L.

\*\*PSHWL 60 Provided only combined with Proshower Base Basic.

PROSHOWER DESIGN - SUPER-POLISHED STAINLESS STEEL AISI 304 / 1.4301 - V2A - Pack. 1 Pc

Article	Lenght cm	Width cm
PSHWD 30*	30	8
PSHWD 60**	60	8
PSHWD 70	70	8
PSHWD 80	80	8
PSHWD 90	90	8
PSHWD 100*	100	8
PSHWD 120*	120	8

\*PSHWD 30,100,120 Provided only combined with Proshower Base L.

\*\*PSHWD 60 Provided only combined with Proshower Base Basic.

PROSHOWER STRIPS - SUPER-POLISHED STAINLESS STEEL AISI 304 / 1.4301 - V2A - Pack. 1 Pc

Article	Lenght cm	Width cm
PSHWST 60**	60	8
PSHWST 70	70	8
PSHWST 80	80	8
PSHWST 90	90	8
PSHWST 100*	100	8
PSHWST 120*	120	8

\*PSHWST 100,120 Provided only combined with Proshower Base L.

\*\*PSHWST 60 Provided only combined with Proshower Base Basic.

PROSHOWER GRILL - SUPER-POLISHED STAINLESS STEEL AISI 304 / 1.4301 - V2A - Pack. 1 Pc

Article	Lenght cm	Width cm
PSHWGR 60**	60	8
PSHWGR 70	70	8
PSHWGR 80	80	8
PSHWGR 90	90	8
PSHWGR 100*	100	8
PSHWGR 120*	120	8

\*PSHWGR 100,120 Provided only combined with Proshower Base L.

\*\*PSHWGR 60 Provided only combined with Proshower Base Basic.

PROSHOWER SQUARE - SUPER-POLISHED STAINLESS STEEL AISI 304 / 1.4301 - V2A - Pack. 1 Pc

Article	Lenght cm	Width cm
PSHWSQ 60**	60	8
PSHWSQ 70	70	8
PSHWSQ 80	80	8
PSHWSQ 90	90	8
PSHWSQ 100*	100	8
PSHWSQ 120*	120	8

\*PSHWSQ 100,120 Provided only combined with Proshower Base L.

\*\*PSHWSQ 60 Provided only combined with Proshower Base Basic.

\* = Production on demand with minimum quantity of 10 pcs. Production delay 4/5 weeks. Price to be agreed

# DRAIN REDUCTION

POLYPROPYLENE

Article	Description	Pc/Pack.
PSHWRD 5040	50 to 40 mm polypropylene drain reduction	1



REDUCTION

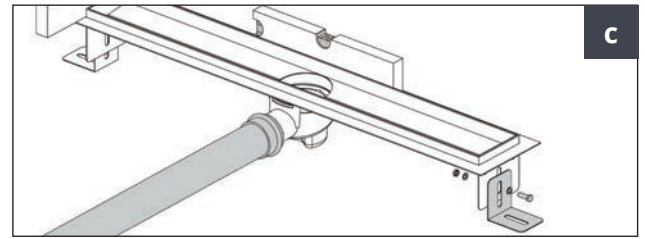
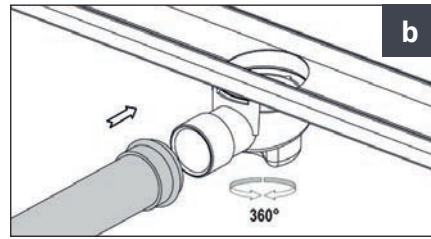
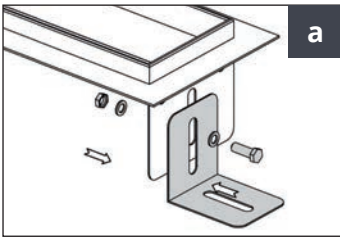

# MODULAR ASSEMBLY KIT

Article	Description	Pc/Pack.
PSHWRD	Modular assembly kit to make drain ducts of any length	1



MODULAR ASSEMBLY KIT

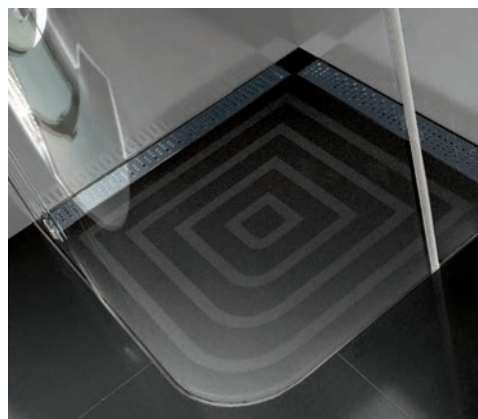
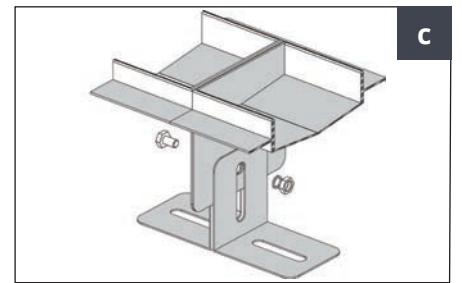
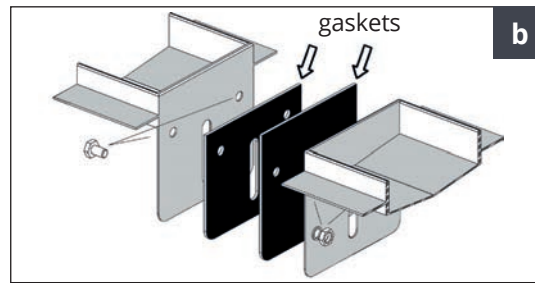
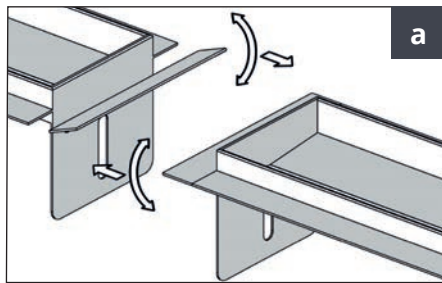

# PROSHOWER BASE L PRO

SUPER-POLISHED  
STAINLESS STEEL AISI 316L / 1.4404 - V4A

PROSHOWER BASE L PRO is a stainless steel AISI 316L / 1.4404 - V4A drain for the realisation of floor-level and for wall shower drain. This drain is available in different lengths and equipped with different grids. The reduced thickness grid has excellent chemical resistance and is equipped with a 360° adjustable siphon.

PSHWP...

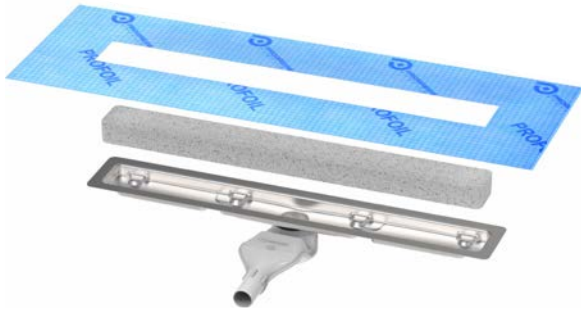

DUCT BODY MADE OF A STAINLESS STEEL AISI 316L / 1.4404 - V4A

Article	Description	Pc/Pack.
PSHWP 30	PROSHOWER BASE L PRO - L 30 x 5,5 cm	1
PSHWP 60	PROSHOWER BASE L PRO - L 60 x 5,5 cm	1
PSHWP 70	PROSHOWER BASE L PRO - L 70 x 5,5 cm	1
PSHWP 80	PROSHOWER BASE L PRO - L 80 x 5,5 cm	1
PSHWP 90	PROSHOWER BASE L PRO - L 90 x 5,5 cm	1
PSHWP 100	PROSHOWER BASE L PRO - L 100 x 5,5 cm	1

Article	Kit components	Pc/Pack.
PSHWPNN...	PROSHOWER BASE L PRO DUCT BODY	1
TASPRF...	PROFOIL SECTION	1
SPSHWPT...	POLYSTYRENE TEMPORARY CHANNEL PROTECTION	1

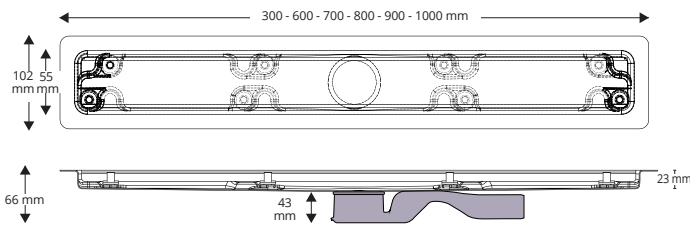

PROSHOWER BASE L PRO  
DUCT BODY  
PSHWPNN...



PROFOIL SECTION  
TASPRF...



POLYSTYRENE TEMPORARY  
CHANNEL PROTECTION  
SPSHWPT...

# PROSHOWER TOP PRO

SUPER-POLISHED STAINLESS STEEL AISI 316L / 1.4404 - V4A

# PROSHOWER TILE/LINE PRO

PSHWPT 30/60/70/80/90/100

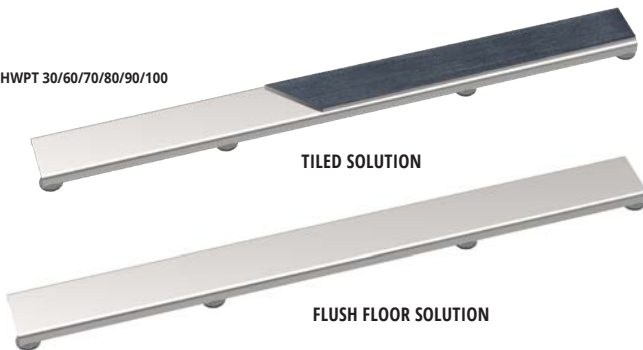

PROSHOWER TILE/LINE PRO - SUPER-POLISHED STAINLESS STEEL AISI 316L/1.4404-V4A - Pack. 1 Pc

Article	Lenght cm	Width cm
PSHWPLT 30	30	5,5
PSHWPLT 60	60	5,5
PSHWPLT 70	70	5,5
PSHWPLT 80	80	5,5
PSHWPLT 90	90	5,5
PSHWPLT 100	100	5,5

Sold only in combination with Proshower Base L PRO

# PROSHOWER DESIGN PRO

PSHWPD 30/60/70/80/90/100

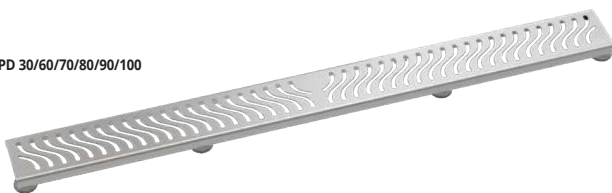

PROSHOWER DESIGN PRO - - SUPER-POLISHED STAINLESS STEEL AISI 316L/1.4404-V4A - Pack. 1 Pc







Article	Lenght cm	Width cm
PSHWPD 30	30	5,5
PSHWPD 60	60	5,5
PSHWPD 70	70	5,5
PSHWPD 80	80	5,5
PSHWPD 90	90	5,5
PSHWPD 100	100	5,5

Sold only in combination with Proshower Base L PRO

**PROSHOWER BASE L PRO** is also equipped with a wall drain box made of AISI 316L / 1.4404 - V4A stainless steel which recessed into the wall, allows to realize wall drains without compromising the water flow and the ease of cleaning.

## WALL DRAIN BOX

### WALL DRAIN BOX STAINLESS STEEL AISI 316L/1.4404-V4A

Article	Description	Pc/Pack.
 <b>KBPSHW PAC 30</b>	PROSHOWER BASE L PRO wall drain box 30 cm	1
 <b>KBPSHW PAC 60</b>	PROSHOWER BASE L PRO wall drain box 60 cm	1
 <b>KBPSHW PAC 70</b>	PROSHOWER BASE L PRO wall drain box 70 cm	1
 <b>KBPSHW PAC 80</b>	PROSHOWER BASE L PRO wall drain box 80 cm	1
 <b>KBPSHW PAC 90</b>	PROSHOWER BASE L PRO wall drain box 90 cm	1
 <b>KBPSHW PAC 100</b>	PROSHOWER BASE L PRO wall drain box 100 cm	1



### INSTALLATION SECTION OF THE WALL DRAIN PROSHOWER BASE L PRO

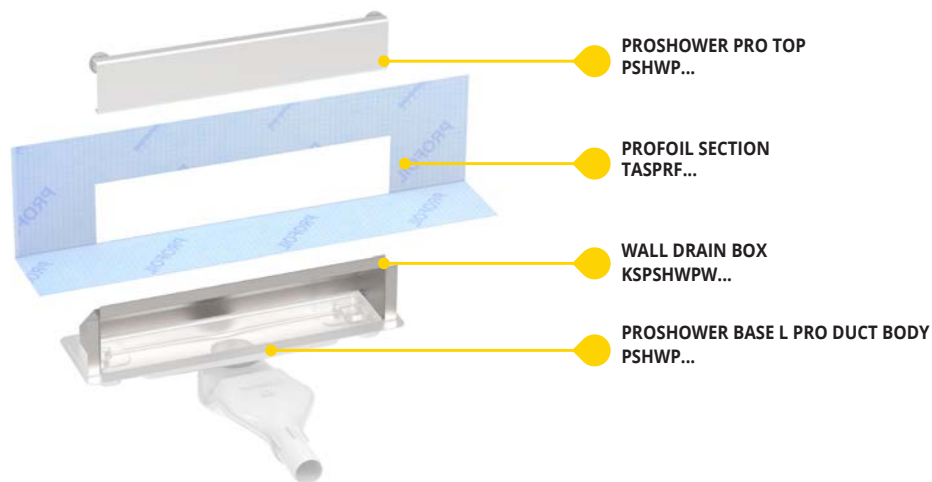



# PROSHOWER PROFILE GLASS

SATINATED STAINLESS STEEL AISI 304 / 1.4301 - V2A

**PROSHOWER PROFILE GLASS** Suitable profile for fixing glass slabs in case of floor level showers with a slope of 2%. Due to its particular shape and finish in satin-finish stainless steel AISI 304 / 1.4301 - V2A, it covers and decorates the visible side of the screed.

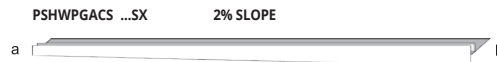
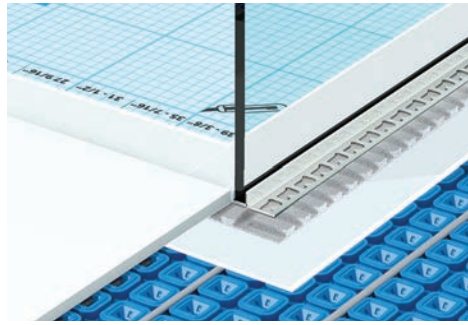
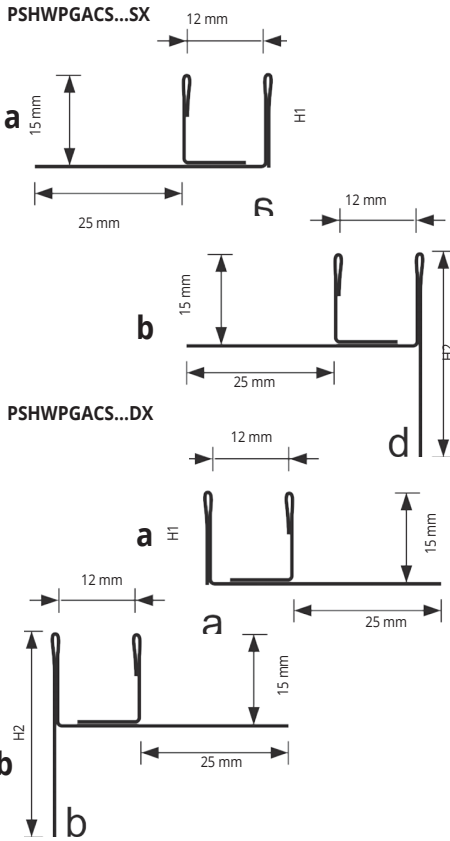

### EXAMPLES AND INSTRUCTIONS FOR LAYING METHODS

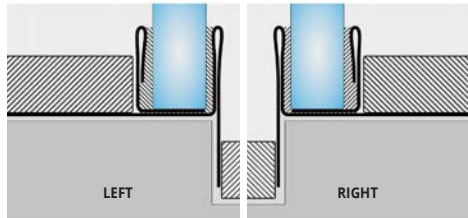

**SATINATED STAINLESS STEEL AISI 304/1.4301-V2A - LEFT**  
degreased and passivated - thermo packed - Pack. 1 Pc

Article	H1 mm	H2 mm	L cm
PSHWPAGACS 100SX	15	33	100
PSHWPAGACS 150SX	15	43	150
PSHWPAGACS 200SX	15	53	200

**SATINATED STAINLESS STEEL AISI 304/1.4301-V2A - RIGHT**  
degreased and passivated - thermo packed - Pack. 1 Pc

Article	H1 mm	H2 mm	L cm
PSHWPAGACS 100DX	15	33	100 cm
PSHWPAGACS 150DX	15	43	150 cm
PSHWPAGACS 200DX	15	53	200 cm

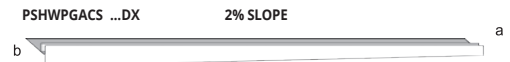

1. Choose "PROSHOWER PROFILE GLASS" according to the desired length.
2. Cut "PROSHOWER PROFILE GLASS" to the desired length and apply the adhesive on the support where the profile will be laid.
3. Press the anchoring flange of "PROJOLLY SQUARE" into the adhesive.
4. Lay the tiles, aligning them with the profile leaving a 2 mm joint.
5. Remove immediately all remains of adhesive from the surface of the profile.
6. Fill the joints between the profile and the tiles with grout, in order to avoid water stagnation. Remove immediately all the remains of grout from the surface of the profile.
7. Insert the sheet of glass and seal.

# PROSHOWER PROFILE

SATINATED STAINLESS STEEL AISI 304 / 1.4301 - V2A

**PROSHOWER PROFILE** is a profile for floor level showers in stainless steel for the protection of the floor edges and as decoration of the screed visible side. The profile has a 2% slope. Its specific shape makes it an easy to lay profile to be used with all kind of floor.

PSHWPACS... SX

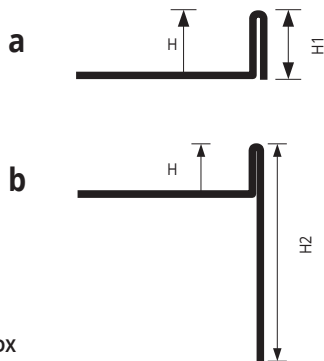

PSHWPACS... DX

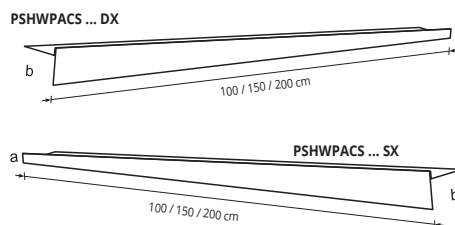
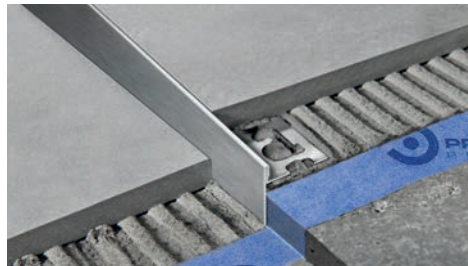
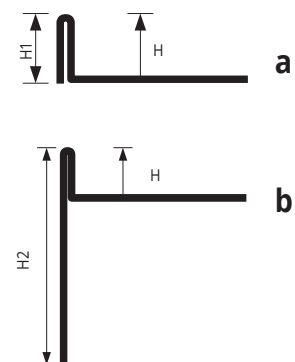

### EXAMPLES AND INSTRUCTIONS FOR LAYING METHODS

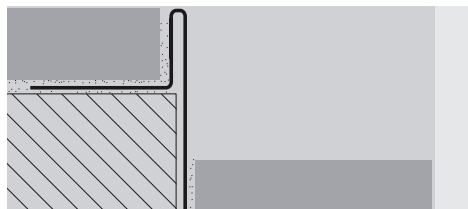

**SATINATED STAINLESS STEEL AISI 304/1.4301-V2A - RIGHT**  
degreased and passivated - thermo packed - Pack. 1 Pc

Article	H mm	H1 mm	H2 mm	L cm
PSHWPACS 1010DX	10	11	28	100
PSHWPACS 1015DX	10	11	38	150
PSHWPACS 1020DX	10	11	48	200
PSHWPACS 12510DX	12,5	13,5	30	100
PSHWPACS 12515DX	12,5	13,5	40	150
PSHWPACS 12520DX	12,5	13,5	50	200

**SATINATED STAINLESS STEEL AISI 304/1.4301-V2A - LEFT**  
degreased and passivated - thermo packed - Pack. 1 Pc

Article	H mm	H1 mm	H2 mm	L cm
PSHWPACS 1010SX	10	11	28	100
PSHWPACS 1015SX	10	11	38	150
PSHWPACS 1020SX	10	11	48	200
PSHWPACS 12510SX	12,5	13,5	30	100
PSHWPACS 12515SX	12,5	13,5	40	150
PSHWPACS 12520SX	12,5	13,5	50	200

1. Choose "PROSHOWER PROFILE" according to the desired length.
2. Cut "PROSHOWER PROFILE" to the desired length and apply the adhesive on the support where the profile will be laid.
3. Press the anchoring flange of "PROJOLLY SQUARE" into the adhesive.
4. Lay the tiles, aligning them with the profile leaving a 2 mm joint.
5. Remove immediately all remains of adhesive from the surface of the profile.
6. Fill the joints between the profile and the tiles with grout, in order to avoid water stagnation. Remove immediately all the remains of grout from the surface of the profile.
7. Insert the sheet of glass and seal.



**PROSHOWER PROFILE FRONT** is a satin-finish stainless steel AISI 304/1.4301-V2A profile. It is suitable to cover and decorate the visible part of wall in front of the shower tray in case of floor level showers with slope.

# PROSHOWER PROFILE FRONT

SATINED STAINLESS STEEL AISI 304 / 1.4301 - V2A

**SATINED STAINLESS STEEL AISI 304/1.4301-V2A**  
degreased and passivated - thermo packed - Pack. 1 Pc

Article	H mm	H1 mm	L cm
PSHWPFACS 101028	10	28	100
PSHWPFACS 101038	10	38	100
PSHWPFACS 101048	10	48	100
PSHWPFACS 101528	10	28	150
PSHWPFACS 101538	10	38	150
PSHWPFACS 101548	10	48	150
PSHWPFACS 1251028	12,5	28	100
PSHWPFACS 1251038	12,5	38	100
PSHWPFACS 1251048	12,5	48	100
PSHWPFACS 1251528	12,5	28	150
PSHWPFACS 1251538	12,5	38	150
PSHWPFACS 1251548	12,5	48	150

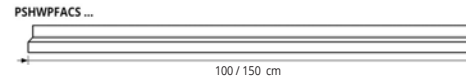
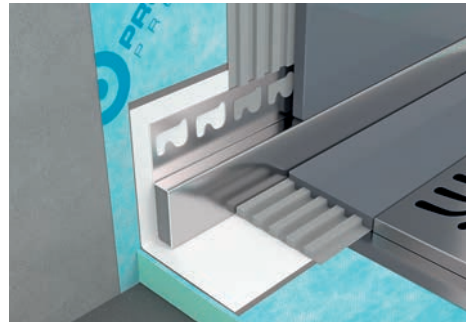

### EXAMPLES AND INSTRUCTIONS FOR LAYING METHODS



1. Choose "PROSHOWER PROFILE FRONT" according to the desired length. 2. Cut "PROSHOWER PROFILE FRONT" to the desired length and apply the adhesive on the support where the profile will be laid. 3. Press the anchoring flange of "PROJOLLY SQUARE" into the adhesive. 4. Lay the tiles, aligning them with the profile leaving a 2 mm joint. Remove immediately all remains of adhesive from the surface of the profile. 5. Fill the joints between the profile and the tiles with grout, in order to avoid water stagnation. Remove immediately all the remains of grout from the surface of the profile. 6. Insert the sheet of glass and seal.

PSHWPFACS 101028 PSHWPFACS 1251028 PSHWPFACS 101038  
PSHWPFACS 101528 PSHWPFACS 1251528 PSHWPFACS 101538

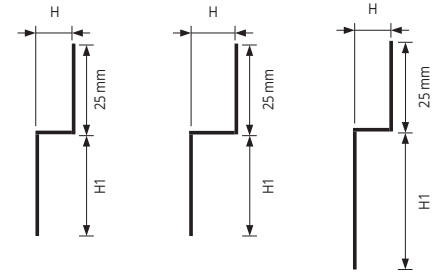

PSHWPFACS 1251038 PSHWPFACS 101048 PSHWPFACS 1251048  
PSHWPFACS 1251538 PSHWPFACS 101548 PSHWPFACS 1251548

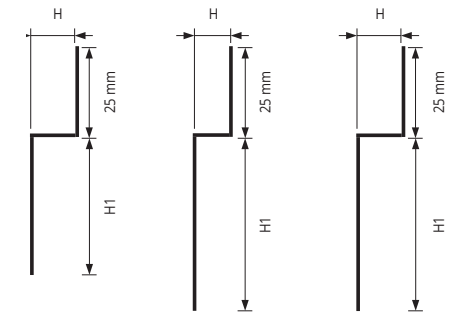

**PROSHOWER PROFILE WALL** Profile in satin-finish stainless steel AISI 304 / 1.4301 - V2A. It is suitable to cover and decorate the visible part of wall beside the shower tray in case of floor level showers with a slope of 2%.

# PROSHOWER PROFILE WALL

SATINED STAINLESS STEEL AISI 304 / 1.4301 - V2A

**SATINED STAINLESS STEEL AISI 304/1.4301-V2A - RIGHT**  
degreased and passivated - thermo packed - Pack. 1 Pc

Article	H mm	H1 mm	H2 mm	L cm
PSHWPLACS 1010DX	10	10	28	100
PSHWPLACS 1015DX	10	10	38	150
PSHWPLACS 1020DX	10	10	48	200
PSHWPLACS 12510DX	12,5	10	28	100
PSHWPLACS 12515DX	12,5	10	38	150
PSHWPLACS 12520DX	12,5	10	48	200

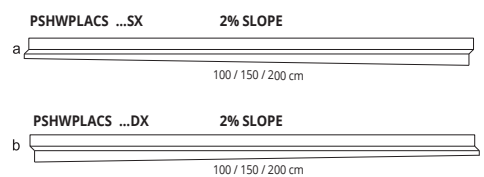

### EXAMPLES AND INSTRUCTIONS FOR LAYING METHODS

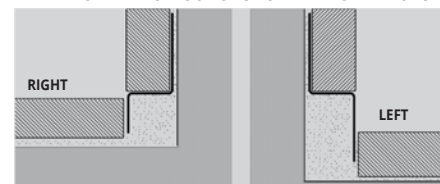

**SATINED STAINLESS STEEL AISI 304/1.4301-V2A - LEFT**  
degreased and passivated - thermo packed - Pack. 1 Pc

Article	H mm	H1 mm	H2 mm	L cm
PSHWPLACS 1010SX	10	10	28	100
PSHWPLACS 1015SX	10	10	38	150
PSHWPLACS 1020SX	10	10	48	200
PSHWPLACS 12510SX	12,5	10	28	100
PSHWPLACS 12515SX	12,5	10	38	150
PSHWPLACS 12520SX	12,5	10	48	200

1. Choose "PROSHOWER PROFILE WALL" according to the desired length. 2. Cut "PROSHOWER PROFILE WALL" to the desired length and apply the adhesive on the support where the profile will be laid. 3. Press the anchoring flange of "PROJOLLY SQUARE" into the adhesive. 4. Lay the tiles, aligning them with the profile leaving a 2 mm joint. Remove immediately all remains of adhesive from the surface of the profile. 5. Fill the joints between the profile and the tiles with grout, in order to avoid water stagnation. Remove immediately all the remains of grout from the surface of the profile. 6. Insert the sheet of glass and seal.

PSHWPLACS ...SX

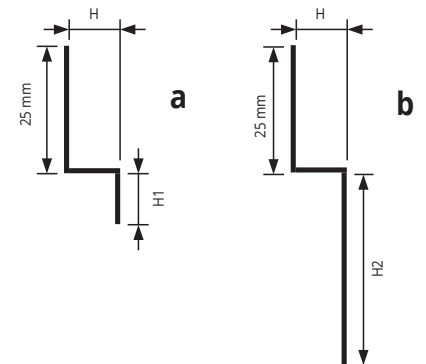

PSHWPLACS ...DX

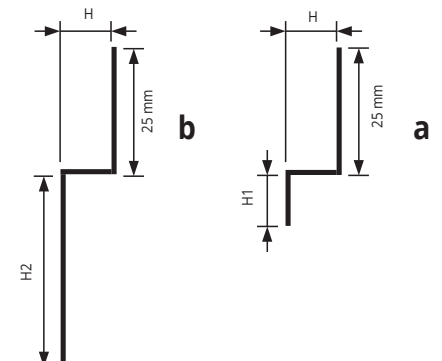

# PROLISTEL CHANNEL

STAINLESS STEEL AISI 304/1.4301-V2A

**PROLISTEL CHANNEL** is a F-shaped strip in polished an satin-finish stainless steel AISI 304/1.4301-V2A suitable to decorate the wall coverings in ceramic tiles and natural stones. Its section allows the realization of a decorative joint which can also be used as a guide for the fixing of sheets of glass on floors and walls. Its particular section and the availability in two different finishes make **PROLISTEL CHANNEL** a much sought-after profile that allows an easy workmanlike application.

PLTCH... 08 - 10 - 11 - 12,5

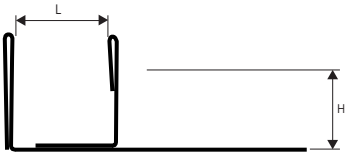

## EXAMPLES AND INSTRUCTIONS FOR LAYING METHODS

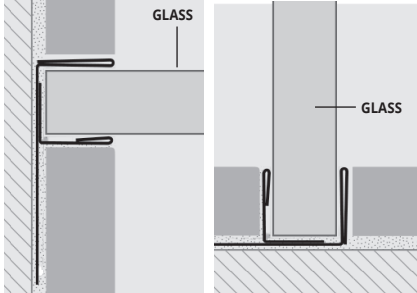

1. Choose "PROLISTEL CHANNEL" according to the visible surface and desired finish. 2. Cut "PROLISTEL CHANNEL" to the desired length and apply the adhesive on the surface where the profile will be laid. 3. Press "PROLISTEL CHANNEL" into the adhesive, aligning it with the tiles leaving a 2 mm. joint. Remove immediately all remains of adhesive from the surface of the profile. 4. Fill the joint between the profile and tiles with grout in order to avoid water stagnation. Remove immediately all the remains of grout from the surface of the profile.

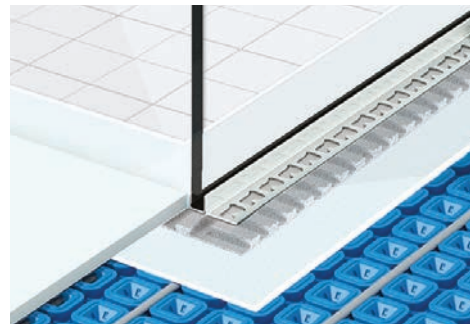

**POLISHED STAINLESS STEEL AISI 304/1.4301-V2A**  
bar length 2,7 lm - pack. 1 Pc

Article	H mm	L mm		
PLTCHAC 0812	8	12		
PLTCHAC 1012	10	12		
PLTCHAC 1112	11	12		
PLTCHAC 12512	12,5	12		

**POLISHED STAINLESS STEEL AISI 304/1.4301-V2A**  
bar length 2,7 lm - pack. 1 Pc

Article	H mm	L mm		
PLTCHAC 0808	8	08		
PLTCHAC 1008	10	08		
PLTCHAC 1108	11	08		
PLTCHAC 12508	12,5	08		

**POLISHED STAINLESS STEEL AISI 304/1.4301-V2A**  
bar length 2,7 lm - pack. 1 Pc

Article	H mm	L mm		
PLTCHAC 0810	8	10		
PLTCHAC 1010	10	10		
PLTCHAC 1110	11	10		
PLTCHAC 12510	12,5	10		



**SATIN-FINISH STAINLESS STEEL AISI 304/1.4301-V2A**  
bar length 2,7 lm - pack. 1 Pc

Article	H mm	L mm		
PLTCHACS 0812	8	12		
PLTCHACS 1012	10	12		
PLTCHACS 1112	11	12		
PLTCHACS 12512	12,5	12		

**SATIN-FINISH STAINLESS STEEL AISI 304/1.4301-V2A**  
bar length 2,7 lm - pack. 1 Pc

Article	H mm	L mm		
PLTCHACS 0808	8	08		
PLTCHACS 1008	10	08		
PLTCHACS 1108	11	08		
PLTCHACS 12508	12,5	08		

**SATIN-FINISH STAINLESS STEEL AISI 304/1.4301-V2A**  
bar length 2,7 lm - pack. 1 Pc

Article	H mm	L mm		
PLTCHACS 0810	8	10		
PLTCHACS 1010	10	10		
PLTCHACS 1110	11	10		
PLTCHACS 12510	12,5	10		

## COLOURS



AC - Polished stainless steel AISI 304/1.4301-V2A  
ACS - Satin finish stainless steel AISI 304/1.4301-V2A

# PROLISTEL CHANNEL

ANODIZED AND POLISHED ALUMINIUM

**PROLISTEL CHANNEL** is a F-shaped strip in anodized and polished aluminum suitable to decorate the wall coverings in ceramic tiles and natural stones. Its section allows the realization of a decorative joint which can also be used as a guide for the fixing of sheets of glass on floors and walls. Its particular section and the availability in two different finishes make **PROLISTEL CHANNEL** a much sought-after profile that allows an easy workmanlike application.

PLTCH... 08 - 10 - 11 - 12,5

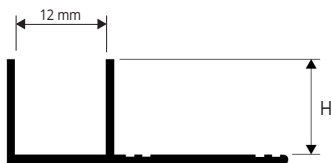

## EXAMPLES AND INSTRUCTIONS FOR LAYING METHODS

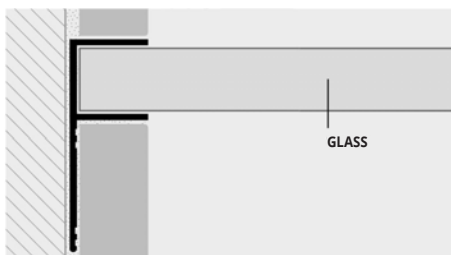

1. Choose "PROLISTEL CHANNEL" according to the visible surface and desired finish. 2. Cut "PROLISTEL CHANNEL" to the desired length and apply the adhesive on the surface where the profile will be laid. 3. Press "PROLISTEL CHANNEL" into the adhesive, aligning it with the tiles leaving a 2 mm. joint. Remove immediately all remains of adhesive from the surface of the profile. 4. Fill the joint between the profile and tiles with grout in order to avoid water stagnation. Remove immediately all the remains of grout from the surface of the profile.

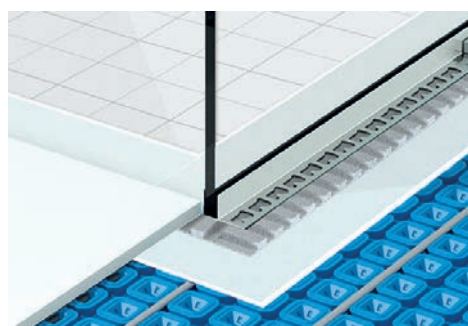

**ANODIZED SILVER ALUMINIUM**  
bar length 2,7 lm - pack. 40 Pcs - 108 lm

Article	H mm		
PLTCHAA 08	8		
PLTCHAA 10	10		
PLTCHAA 11	11		
PLTCHAA 125	12,5		



**POLISHED CHROME ALUMINIUM**  
bar length 2,7 lm - pack. 40 Pcs - 108 lm

Article	H mm		
PLTCHBC 08	8		
PLTCHBC 10	10		
PLTCHBC 11	11		
PLTCHBC 125	12,5		

## COLOURS

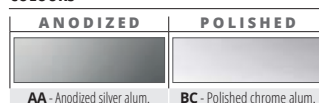

AA - Anodized silver alum. BC - Polished chrome alum.

= News 2021

= Production on demand with minimum quantity of 100 pcs. Production delay 4/5 weeks. Price to be agreed



# PROSHOWER CENTRAL KIT SYSTEM

PROSHOWER CENTRAL KIT SYSTEM is an innovative solution, which combines functionality and design to answer to all requirements of the shower.



Article	Description	Pc/Pack.
PSHPANCEK	PROSHOWER CENTRAL KIT SYSTEM	1

Article	Kit components	Pc/Pack.
PSHPANC	PROSHOWER PANEL CENTRAL - moulded polystyrene 120 cm x 120 cm	1
PRBFXB	PROBAND FIX white	2
PRBPE 1507	PROBAND 150 - 7,5 lm	1
PFLO 0405	PROFOIL ROLL - 5 lm	1
PRSPD 10	PVC TOWEL	1
PSHLDK	PROSHOWER DRAIN LATERAL KIT	1



PROSHOWER PANEL CENTRAL  
PSHPANC



PROFOIL  
PFLO 0405



PROBAND 150  
PRBPE 1507



PROBAND FIX  
PRBFXB



PVC TOWEL  
PRSPD 10

Article	Description	Pc/Pack.
PSHPANC	PROSHOWER PANEL CENTRAL - moulded polystyrene 120 cm x 120 cm	1

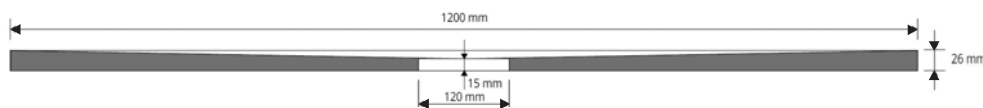

PROSHOWER PANEL CENTRAL  
PSHPANC

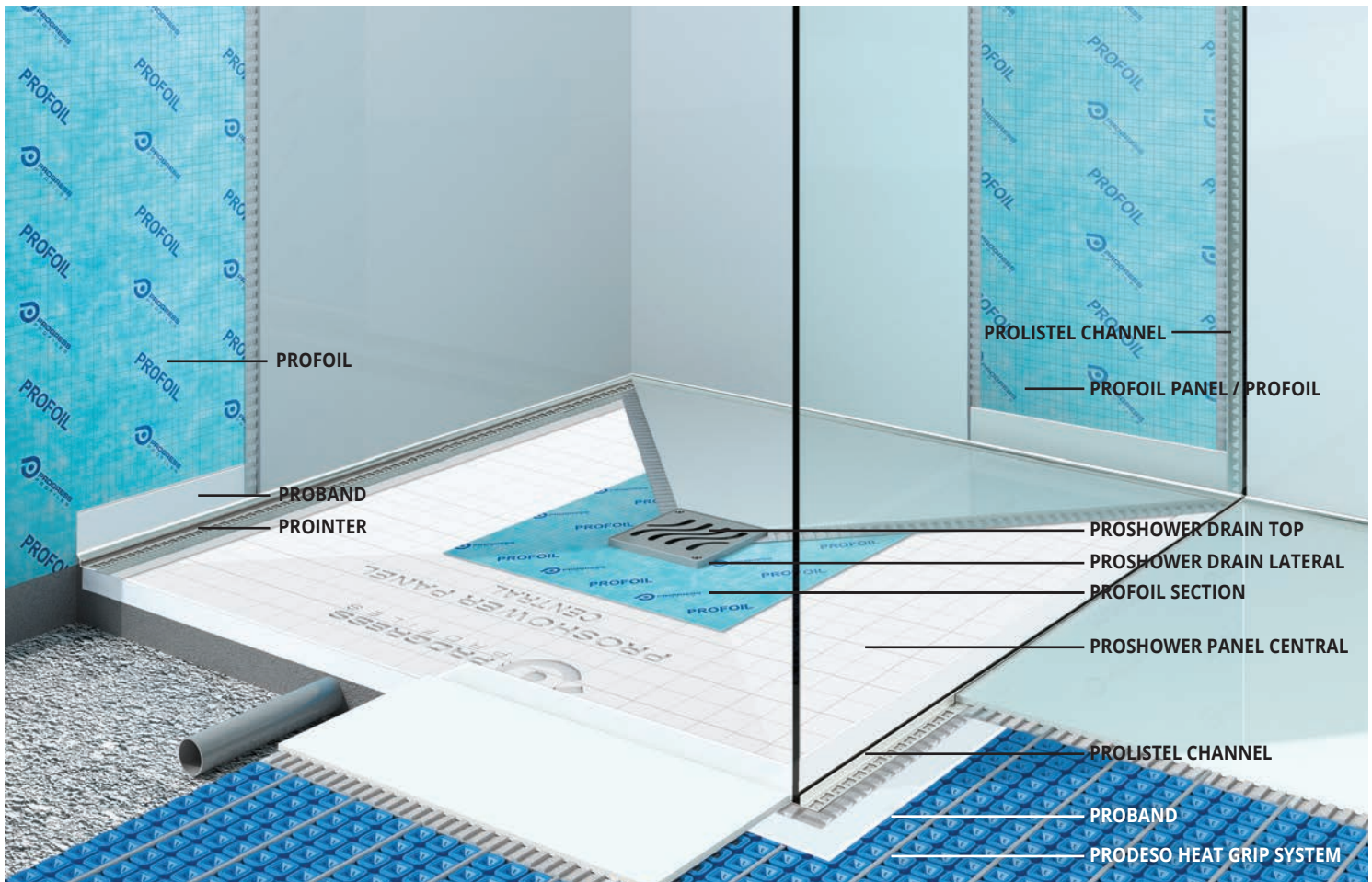

**PROSHOWER LATERAL DRAIN KIT** are 2 central drain systems with lateral outflow equipped with a siphon, grate support, stainless steel grate, butyl double-sided ring for the fixing of the waterproof section, waterproof section and a protection cap with template function too that allows the correct positioning of the butyl ring and the waterproof section. LATERAL AND VERTICAL DRAIN KIT ensure a correct flow of rainwater.

## PROSHOWER DRAIN KIT

LATERAL AND VERTICAL DRAINS

Article	Description	Pc/Pack.
PSHLDK	PROSHOWER DRAIN LATERAL KIT	1

### AREA OF USE

- **Use** - PROSHOWER BASE L PRO it can be used in any indoor and outdoor environment.
- **Don't use** - In environments where very aggressive substances are used and a high concentrated load is expected.

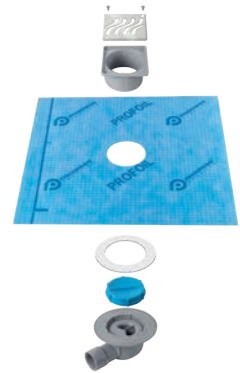

**PROSHOWER DRAIN CENTRAL PRO** is a 10x10 cm stainless steel AISI 316L / 1.4404 - V4A drain for the realisation of floor-level shower. This low thickness drain is equipped with a grid that can also be tiled for floor-level drains. PROSHOWER DRAIN CENTRAL PRO has excellent chemical resistance and is equipped with a 360° adjustable siphon.

## PROSHOWER DRAIN CENTRAL PRO

LATERAL DRAIN

### PROSHOWER DRAIN CENTRAL PRO - GRATE + POLYSTYRENE CHANNEL PROTECTION + PROFOIL SECTION + DUCT BODY + SIPHON

Article	Description	Pc/Pack.
PSHWCP	PROSHOWER DRAIN CENTRAL PRO	1

### AREA OF USE

- **Use** - Balconies, terraces, outdoor surfaces of any size, kitchens and showers.
- **Don't use** - In environments subject to heavy traffic and where washing with acidic and strong alkaline substances is foreseen.

### WARNINGS

After the drain installation, apply the protective cap. Before applying the butyl double-sided adhesive ring on the flange of the drain, thoroughly clean the flange of any dirt residue that may compromise its adhesion. Apply the butyl double-sided adhesive ring and the waterproofing section during the application of the waterproofing system.

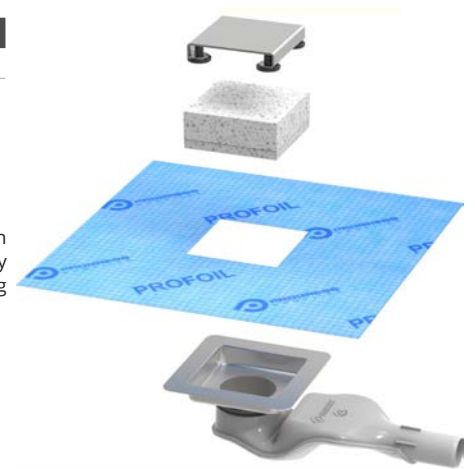



# PROFOIL PANEL

HIGH DENSITY EXTRUDED  
POLYSTYRENE PANEL

PROFOIL PANEL are high density extruded polystyrene panels covered on both sides with a steam- and waterproofing membrane. The membrane is waterproofing and the adhesive to fix them reinforces the panels for a quick and inexpensive laying.

PFLPAN...

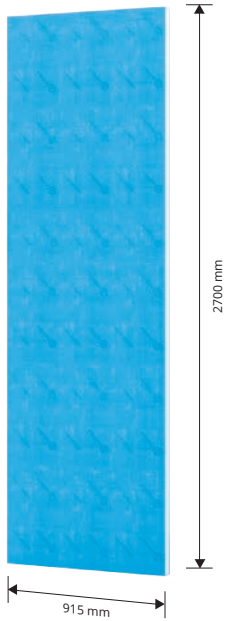

PROFOIL PANEL 2700 mm - high density extruded polystyrene  
915 mm x 2700 mm = 2,470 m<sup>2</sup>

Article	H mm	Pcs/pallet	Mq/pallet		
PFLPAN927	9,50	80	197,60		
PFLPAN1327	12,70	60	148,20		
PFLPAN1627	15,90	50	123,50		
PFLPAN2527	25,00	30	74,10		
PFLPAN3827	38,10	20	49,40		
PFLPAN5027	50,80	15	37,05		

PROFOIL PANEL in 1524 mm is available only in small quantity.  
Please contact the office for availability.

PROFOIL PANEL THICKNESS

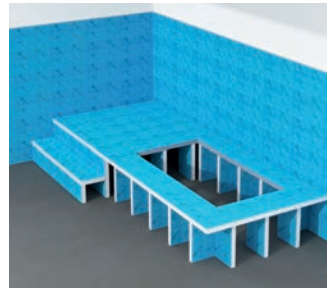
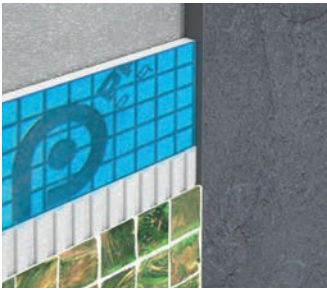
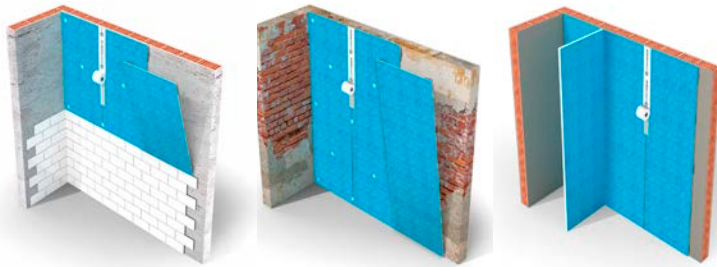
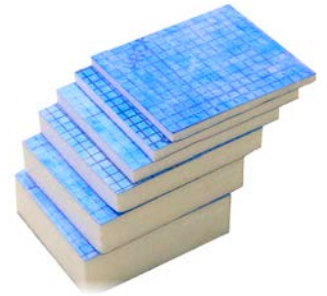
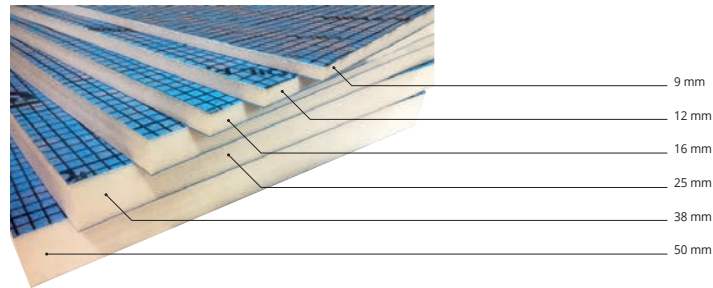

## PROFOIL AND PROBAND DOWELS, WASHERS, SCREWS

STAINLESS STEEL/ZINC-COATED METAL/GLASS FIBER NET



PROFOIL DOWELS - ZINC-COATED METAL - pack. 250 Pc

Article	L mm		
TZPFP 110	100		
TZPFP 140	140		
TZPFP 170	170		
TZPFP 200	200		



PROFOIL DOWELS - STAINLESS STEEL - pack. 250 Pc

Article	L mm		
TIPFP 110	110		
TIPFP 140	140		
TIPFP 170	170		
TIPFP 200	200		
TIPFP 250	250		



PROFOIL PANEL SCREWS (ZINC-COATED METAL)

Article	Pcs/Pack.	L mm	
VACFPF 35	1000	35	
VACFPF 55	1000	45	
VACFPF 80	1000	80	



PROFOIL PANEL WASHERS (ZINC-COATED METAL) - pack. 100 Pc

Article	Pcs/Pack.	ø mm	
RFPPF 36	100	35	

**PROFOIL PANEL NICHE** are prefabricated built-in elements of PROFOIL PANEL to make indoor wall niches and support surfaces. The niches can be linked to the waterproofing systems PROFOIL and PROFOIL PANEL. The fixing of the shelf inside the niche is optional. The shelf, part of the, can be fixed at the needed height. It is available in 4 sizes.

# PROFOIL PANEL NICHE

HIGH DENSITY EXTRUDED POLYSTYRENE

## PROFOIL PANEL NICHE - WATERPROOFING NICHE

Article	Description	Pcs/Pack.
<b>PFLPANICH 88</b>	WATERPROOFING NICHE MADE OF PROFOIL PANEL of 12,5mm, Inside size of the niche 203,2 x 203,2 mm	1
<b>PFLPANICH 1212</b>	WATERPROOFING NICHE MADE OF PROFOIL PANEL of 12,5mm, Inside size of the niche 304,8 x 304,8 mm	1
<b>PFLPANICH 821</b>	WATERPROOFING NICHE MADE OF PROFOIL PANEL of 12,5mm, Inside size of the niche 203,2 x 533,4 mm	1
<b>PFLPANICH 1221</b>	WATERPROOFING NICHE MADE OF PROFOIL PANEL of 12,5mm, Inside size of the niche 304,8 x 533,4 mm	1

PFLPANICH 88

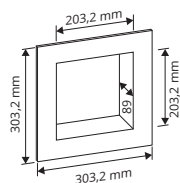

PFLPANICH 1212

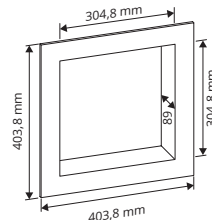

PFLPANICH 821

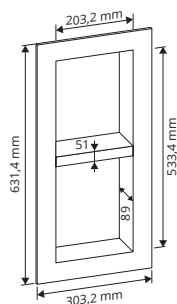

PFLPANICH 1221

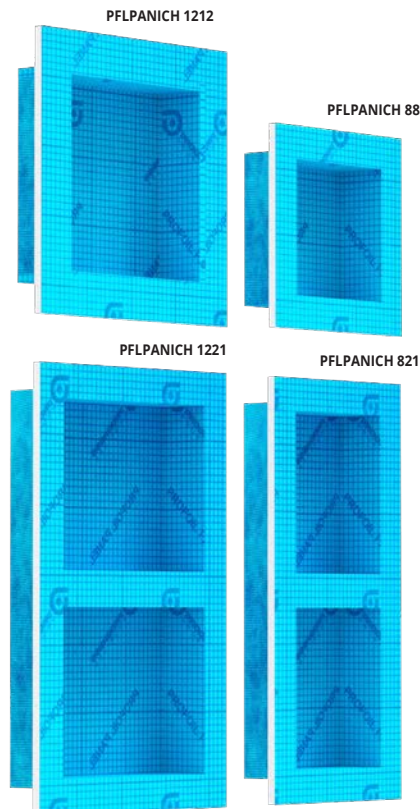
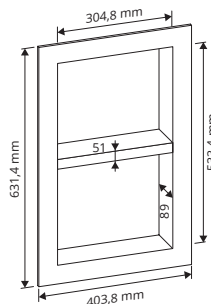



# PROFOIL PRO

ROLLS IN HDPE AND PP

**PROFOIL** is a waterproofing polyethylene membrane with nonwoven polypropylene fabric on both side that guarantees high adhesion to the support.

**PROFOIL PRO** is a waterproofing elastic polyethylene membrane with nonwoven polypropylene fabric on both side that guarantees high adhesion to the support.

**PROFOIL - ROLLS IN HDPE AND PP - Thickness 0,42 mm** ROLLS IN HDPE AND PP - Thickness 0,42 mm

Article	Width roll H x L lm	total m <sup>2</sup>	Rolls/pallet
PFLO 0430	1 x 30	30	40
PFLO 0405	1 x 5	5	154

**PROFOIL PRO - ELASTIC ROLLS IN HDPE AND PP - Thickness 0,42 mm PP**

Article	Width roll H x L lm	total m <sup>2</sup>	Rolls/pallet
PFLOPR 0430	1 x 30	30	40

## AREAS OF USE

• **Use.** Waterproofing of substrates and vertical structures before the laying of ceramic in areas subject to occasional contact with water like bathrooms and kitchens, saunas and Turkish baths. **PROFOIL PRO** can also be used in environments with permanent contact with water like swimming pools and tanks. • **Don't use.** On bituminous coverings, over insulating panels and lightweight screed.

## WARNINGS

Store in a cool and dry place avoiding direct sunlight and sources of heat. Read the data sheet before applying; in case of special applications please call the technical department.

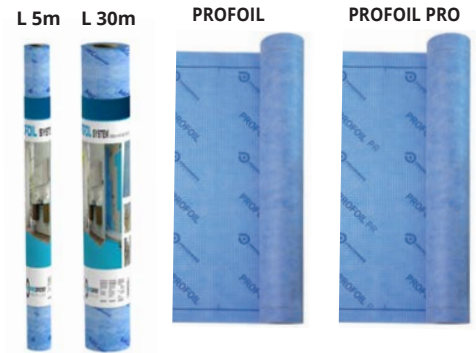

# PROFOIL PASTE

WATERPROOFING ELASTIC MEMBRANE

**PROFOIL PASTE** is a ready to use thin-layer waterproofing elastic membrane with low emissions of volatile organic compounds.



**WATERPROOFING ELASTIC MEMBRANE**

Article	Kg./ Bucket	Bucket/ Pallet
PFLOPST 04	4	64
PFLOPST 10	10	36

## AREAS OF USE

• **Use.** Waterproofing for bathrooms, kitchens, showers, gypsum-based plasters, cement-based plaster and plasterboard walls. • **Don't use.** For external application, on wet surfaces or substrates subject to moisture rising, in environments where water is always present, pools and tanks.

## WARNINGS

Store in a cool and dry place avoiding direct sunlight and sources of heat. Read the data sheet before applying; in case of special applications please call the technical department.

# PROBAND 150/250

ELASTIC ROLLS IN HDPE AND PP



ROLLS IN HDPE AND PP - Thickness 0,42 mm

Article	Roll width H mm x L lm	Rolls/ Pack.
PRBPE 1507	150 x 7,5	16
PRBPE 1530	150 x 30	6
PRBPE 2530	250 x 30	3

# CORNERS and PIPE COLLAR

HDPE E PP

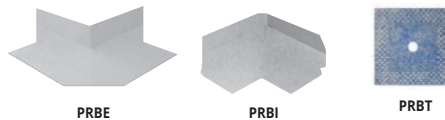

**PREFORMED ELASTIC CORNERS AND PIPE COLLAR IN HDPE AND PP**  
Thickness 0,42 mm

Article	H x L mm
PRBI	60 x 120
PRBE	60 x 120
PRBT	125 x 125

# PROBAND FIX

MOISTURE-CURE SEALANT



**MOISTURE-CURE SEALANT**  
pack. of 12 cartridges - B (white) - G (grey)

Article	Cartridge lm
PRBFXB	290
PRBFXG	290



**GUN FOR MOISTURE-CURE SEALANT CARTRIDGE**

Article	Pc/Pack
PRBFXGUN	1



**MOISTURE-CURE SEALANT CARTRIDGE**  
pack. of 12 cartridges - B (white) - G (grey)

Articolo	Cartridge lm
PRBFXUB	600
PRBFXUG	600





**PROSHELF** are tileable shelves in stainless steel AISI 316/1.4404-V4A for the underile installation. Thanks of their perforated fixing flaps, they are easily installed on the wall during the laying of the ceramic coating. They are available in 2 shapes, triangular for the corner installation and rectangular. These shelves are suitable for the installation in Bathroom and kitchens.

# PROSHELF

STAINLESS STEEL AISI 316/1.4404-V4A

## PROSHELF - STAINLESS STEEL AISI 316/1.4404-V4A TRIANGULAR TILEABLE SHELF

Article	size	Pc/Pack.	
PRSHLFTP24	170 mm x 240 mm	1	
PRSHLFTP30	212 mm x 300 mm	1	

## PROSHELF - STAINLESS STEEL AISI 316/1.4404-V4A RECTANGULAR TILEABLE SHELF

Article	size	Pc/Pack.	
PRSHLFRP40	150 mm x 400 mm	1	
PRSHLFRP30	115 mm x 300 mm	1	

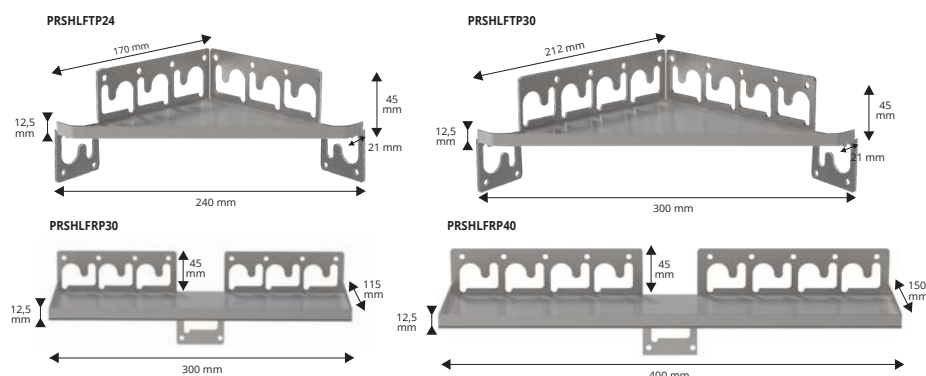

## PROSHELF - STAINLESS STEEL AISI 316/1.4404-V4A TRIANGULAR SHELF

Article	size	Pc/Pack.	
PRSHLFTD24	170 mm x 240 mm	1	
PRSHLFTD30	212 mm x 300 mm	1	

## PROSHELF - STAINLESS STEEL AISI 316/1.4404-V4A RECTANGULAR SHELF

Article	size	Pc/Pack.	
PRSHLFRD40	150 mm x 400 mm	1	
PRSHLFRD30	115 mm x 300 mm	1	

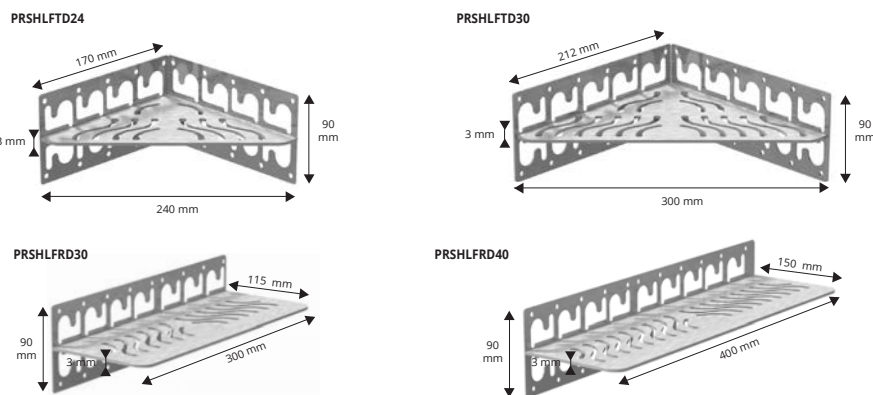

## EXAMPLES OF LAYING

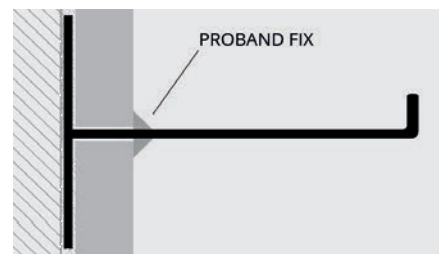

1. Choose "PROSHELF" according to the desired shape and size.
2. apply the adhesive on the support where the shelf will be installed.
3. Press the anchoring flap into the adhesive;
4. Lay the tiles taking care to align them with the shelf. Immediately remove adhesive residues from the surface of the shelf.
5. Carefully seal the joints between the shelf and tiles with PROBAND FIX to avoid water stagnation. Remove any grout residue from the shelf surface.

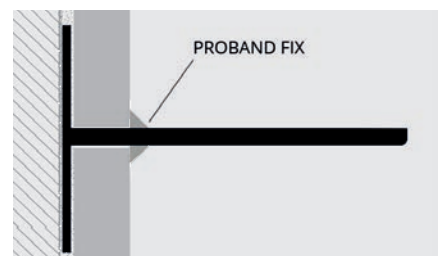

**PRO GOBOARD PANEL** highdensity polyisocyanurate foam panel, covered on both sides with a fibre-glass reinforced cement-based waterproof coating to allow the laying of tiles. The panels, tested for a resistance long duration, are available in thickness of 6,25 / 12,5 / 25 and 50 mm, size of 92 x 152 cm and 122 x 244 cm and can be used on floors, false ceilings, walls, showers and ceilings.

# PRO GOBOARD PANEL

HIGH DENSITY POLYISOCYANURATE FOAM PANEL

## PRO GOBOARD PANEL - highdensity polyisocyanurate foam

Article	Description	Pcs/pallet	m <sup>2</sup> /pallet
PGOBOR06	PRO GOBOARD H 6,25 mm - 92 cm x 152 cm - 1,40 m <sup>2</sup>	75	105
PGOBOR125	PRO GOBOARD H 12,5 mm - 92 cm x 152 cm - 1,40 m <sup>2</sup>	60	84
PGOBOR25	PRO GOBOARD H 25 mm - 122 cm x 244 cm - 2,98 m <sup>2</sup>	30	89,4
PGOBOR50	PRO GOBOARD H 50 mm - 122 cm x 244 cm - 2,98 m <sup>2</sup>	15	44,70

## PGOBOR...



# PROHEATER SYSTEM

PROHEATER is a wall porcelain stone tiled design heater that warms your bathroom with elegance and style

## PROHEATER - WALL PORCELAIN STONE TILED HEATING SYSTEM

Article	Description
PHTST...	Proheater 60 x 152 cm <span style="float: right;">*</span>

Available in various ceramic finishes. The code of the chosen color must be added to the article code.  
Ex: PHTST... (chosen color 01 - Lincoln); PHTST01.

## PROHEATER TOWEL RACK - Pack. 2 Pcs

Article	Description
PHTPSB	White varnished metal towel rack <span style="float: right;">*</span>
PHTPSN	Black varnished metal towel rack <span style="float: right;">*</span>

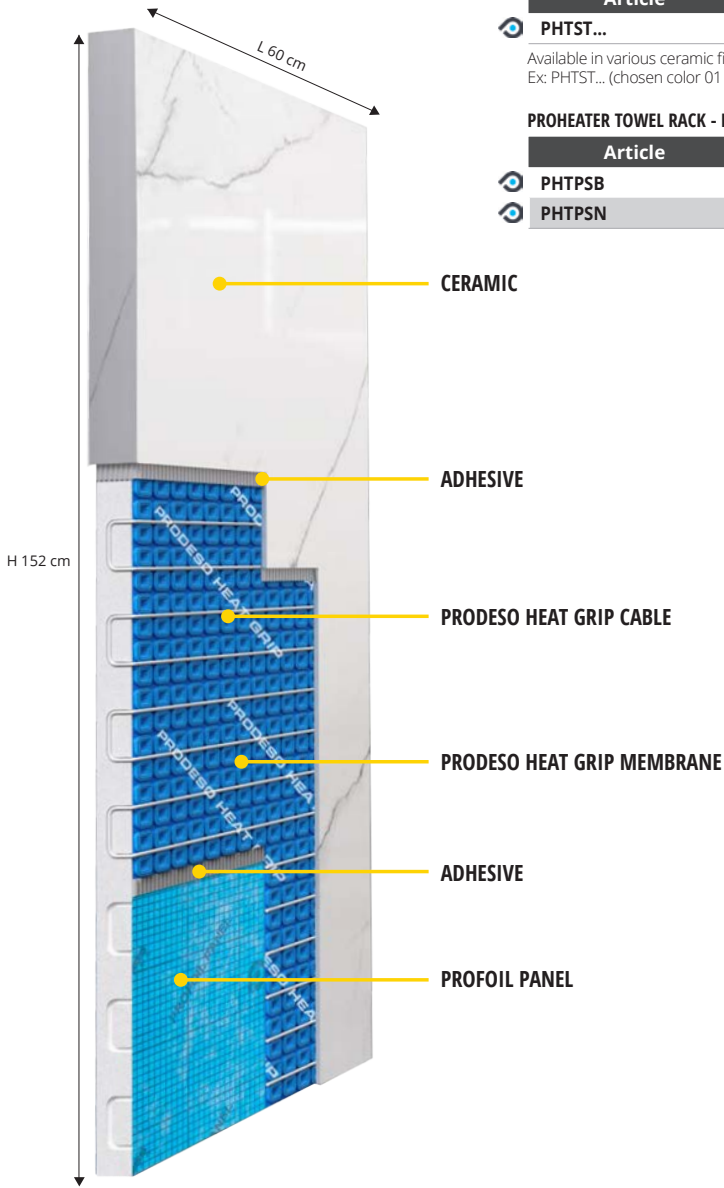

## PROHEATER WITH TOWEL RACK



## CERAMIC COLOR RANGE



= News 2022

= Production on demand. Production delay 4/5 weeks.



**PATENTED**





An interpretation of:  
**Grande Arche De la Défense, J. Otto von Spreckelsen,  
PARIS (France), 1989**

SKIRTING BOARDS

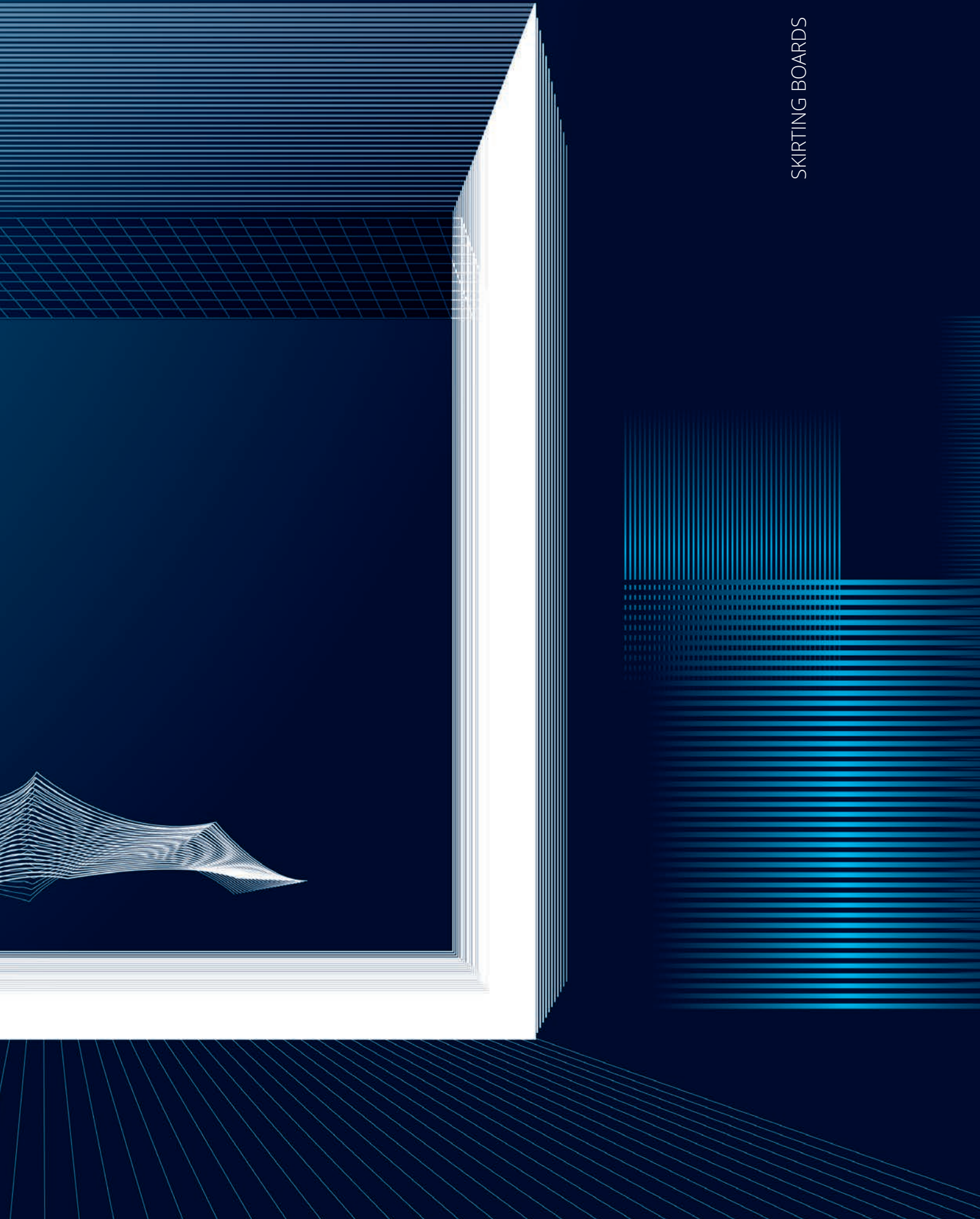



**PROSKIRTING CHANNEL** is the new innovative skirting designed with an integrated system for plasterboard walls, and devised to create a skirting flush to the wall with decorative inner grooves for a modern and contemporary touch.

# PROSKIRTING CHANNEL

ANODIZED, BRUSHED, VARNISHED ALUMINIUM



**SUPPORT/ PERFORATED BASE - ANODIZED SILVER ALUM.**  
thermo packed - bar length 2 lm - pack. 20 Pcs - 40 lm

Article	H mm		
PKGCFAA 75	75		

ORDER THE SUPPORT AND THE TOP YOU WISH

**VISIBLE TOP - ANODIZED, BRUSHED, WHITE VARNISHED ALUM.**  
thermo packed bar length 2 lm - pack. 20 Pcs - 40 lm

Article	H mm		
PKCHAA 55	55		
PKCHBS 55	55		
PKCHA 55-01	55		

On demand may be realised in other finishes of the colour chart.  
Contact our customer service for minimum quantity, timing and price.

**EXTERNAL /INTERNAL CORNER - ANODIZED, BRUSHED, WHITE VARNISHED ALUM.** - pack. 5 Pcs

Article	H mm	€/Pack
REPCHAA 55/5	55	
REPCHBS 55/5	55	
REPCHA 55-01/5	55	



**END CAPS - ANODIZED, BRUSHED, WHITE VARNISHED ALUM.** - pack. 10 Pcs

Article	H mm	€/Pack
TPKCHAA 55/10	60	
TPKCHBS 55/10	60	
TPKCHA 55-01/10	60	

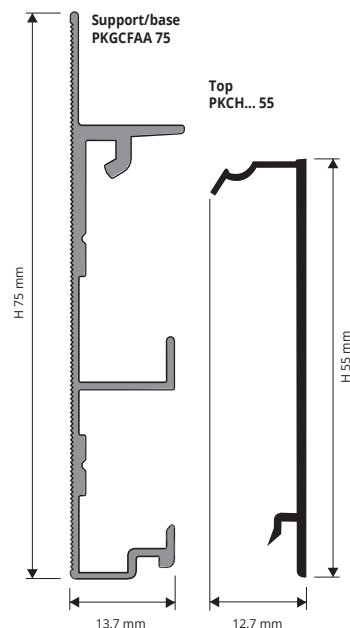

COLOURS

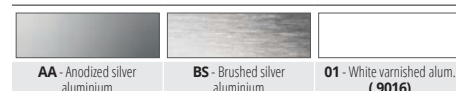

EXAMPLES OF LAYING for instructions see the product below

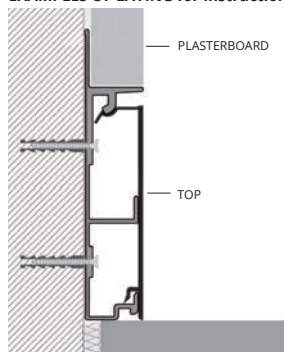

**PROSKIRTING FLAT** is the new innovative skirting designed with an integrated system for plasterboard walls, and devised to create a skirting flush to the wall for a modern and contemporary touch.

# PROSKIRTING FLAT

ANODIZED, BRUSHED, VARNISHED ALUMINIUM



**SUPPORT/ PERFORATED BASE - ANODIZED SILVER ALUM.**  
thermo packed - bar length 2 lm - pack. 20 Pcs - 40 lm

Article	H mm		
PKGCFAA 75	75		

ORDER THE SUPPORT AND THE TOP YOU WISH

**VISIBLE TOP - ANODIZED, BRUSHED, WHITE VARNISHED ALUM.**  
thermo packed - bar length 2 lm - pack. 20 Pcs - 40 lm

Article	H mm		
PKFLAA 60	60		
PKFLBS 60	60		
PKFLA 60-01	60		

On demand may be realised in other finishes of the colour chart.  
Contact our customer service for minimum quantity, timing and price.

**EXTERNAL / INTERNAL CORNER - ANODIZED, BRUSHED, WHITE VARNISHED ALUM.** - pack. 5 Pcs

Article	H mm	€/Pack
REPFLAA 60/5	60	
REPFLBS 60/5	60	
REPFLA 60-01/5	60	



**END CAPS - ANODIZED, BRUSHED, WHITE VARNISHED ALUM.** - pack. 10 Pcs

Article	H mm	€/Pack
TPKCHAA 55/10	60	
TPKCHBS 55/10	60	
TPKCHA 55-01/10	60	

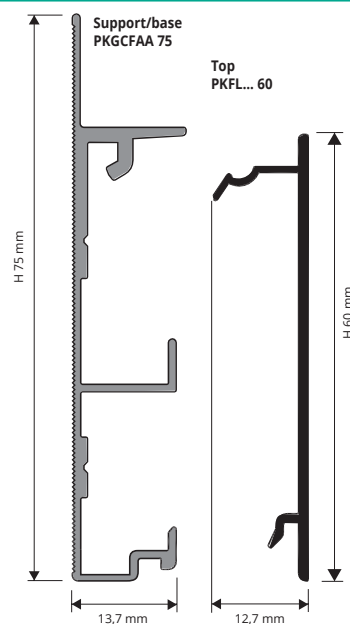

COLOURS



EXAMPLES AND INSTRUCTIONS FOR LAYING METHODS

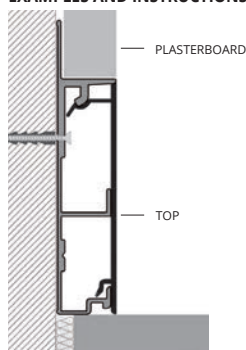

1. Fix the substrate/perforated base to the wall before laying the plasterboard, calculating all the heights and distances. 2. Lay the plasterboard aligning the lower part flush to the "PROSKIRTING CHANNEL" and/or FLAT. 3. Plaster and carry out the surface finishing on the plasterboard. 4. Choose the required Top "PROSKIRTING CHANNEL" and/or FLAT finish, cut and lay the profile fitting the lower part and then the upper part by pressing gently. **IMPORTANT:** Pay attention to the external edges of the aluminium Proskirting. They must be protected against agents such as adhesives and sealants and against grinding or scraping actions.

# PROSKIRTING INS

ANODIZED SILVER ALUMINIUM

**PROSKIRTING INS** is the new innovative skirting designed with an integrated system for plasterboard walls, and devised to create a recessed skirting for a modern and minimalist design in line with the latest trends.

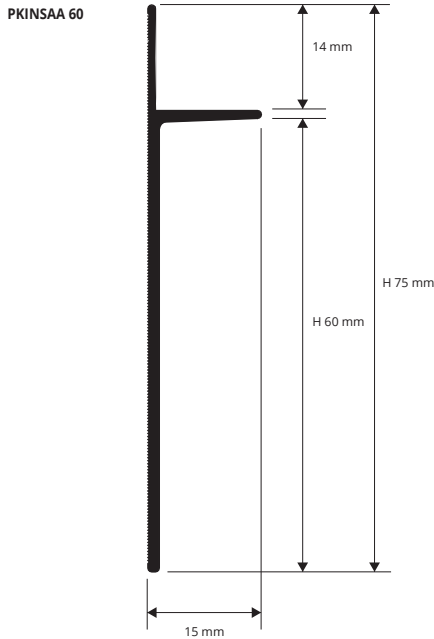

**ANODIZED SILVER ALUMINIUM thermo packed**  
bar length **2 lm** - pack. **30 Pcs - 60 lm**

Article	H x L mm
PKINSAA 60	60 X 15

ON DEMAND MAY BE REALISED IN OTHER FINISHES OF THE COLOUR CHART. CONTACT OUR CUSTOMER SERVICE FOR MINIMUM QUANTITY (MINIMUM QUANTITY ORDER OF 500 LM), TIMING AND PRICE.

## COLOURS



AA - Anodized silver alum.

## EXAMPLES AND INSTRUCTIONS FOR LAYING METHODS

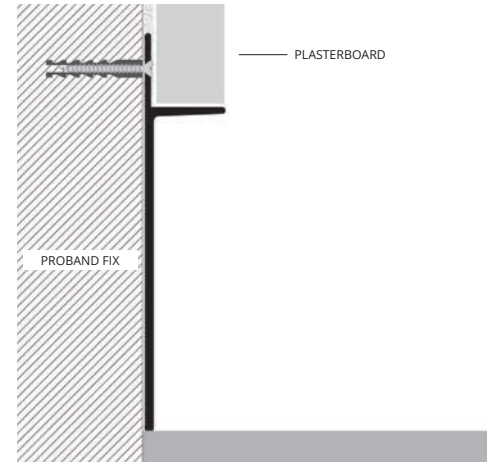

1. Fix "PROSKIRTING INS" using screws (concealed part) and glue/silicone (exposed side), before laying the plasterboard, calculating all the heights and distance. 2. Lay the plasterboard aligning the lower part flush to the "PROSKIRTING INS". 3. Plaster and carry out the surface finishing on the plasterboard.

USE PROBAND FIX FOR FIXING THE PROFILE TO THE WALL



# PROSKIRTING LINE

ANODIZED SILVER ALUMINIUM

**PROSKIRTING LINE** in the innovative skirting suitable for smoothed lime, marmorino, stucco, and Venetian coats on civil plaster or plasterboard.

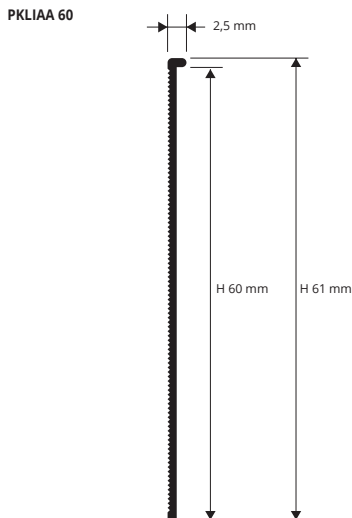

**ANODIZED SILVER ALUMINIUM thermo packed**  
bar length **2 lm** - pack. **40 Pcs - 80 lm**

Article	H x L mm
PKLIAA 60	61 x 2,5

ON DEMAND MAY BE REALISED IN OTHER FINISHES OF THE COLOUR CHART. CONTACT OUR CUSTOMER SERVICE FOR MINIMUM QUANTITY (MINIMUM QUANTITY ORDER OF 500 LM), TIMING AND PRICE.

## COLOURS

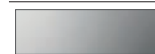

AA - Anodized silver alum.

## EXAMPLES AND INSTRUCTIONS FOR LAYING METHODS

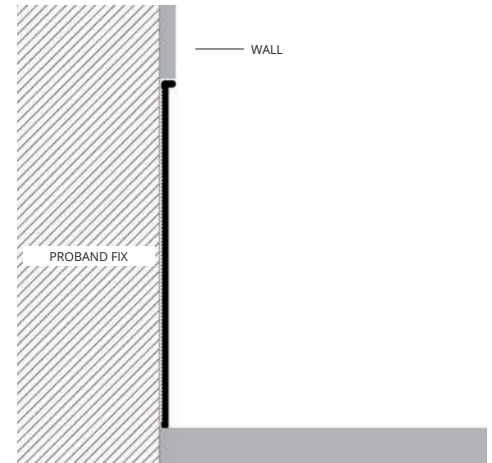

1. Fix the "PROSKIRTING LINE" using glue/silicone (exposed side), before making the required coat, calculating all the heights and distances. 2. Carry out the surface finishing aligning the lower part flush to the "PROSKIRTING LINE".

USE PROBAND FIX FOR FIXING THE PROFILE TO THE WALL







**PROSKIRTING ISP** is a joint, inspectional "cable duct" baseboard in aluminium, conceived and designed to hide and protect the passage of electric cables, the ones for computer, telephones and other plants as well, allowing an easy and quick access. The supports that are to be fixed on the wall consent accommodate different utility wires/cables as well. Aesthetically pleasant, it is recommended for various public and private environments: offices, schools, residences, commercial centers etc. Available in silver anodized aluminium (H: 100 mm) and in polished titanium and brushed titanium aluminium (H: 70 mm). In order to facilitate and to perfect the laying process, internal and external angles, plugs and junctions are recommended.

# PROSKIRTING ISP

SILVER ANODIZED ALUMINIUM, TITANIUM POLISHED AND BRUSHED ALUM. (H:70 MM)

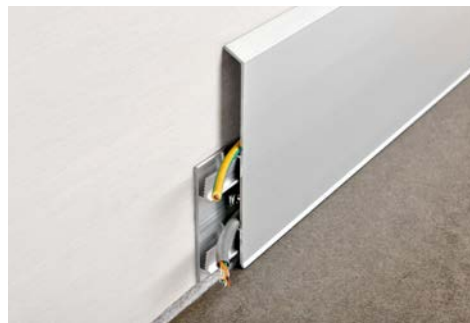

**SKIRTING ANODIZED SILVER ALUMINIUM**  
thermo packed - bar length 2 lm - pack. 25 Pcs - 50 lm

Article	H mm
PKISPAA 70	70
PKISPAA 100	100

**PUNCHED SUPPORT**  
support length 2 cm - pack. 10 Pcs

Article	H mm
PKGS 55	55

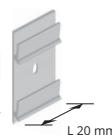

ARTICLES NOT FOR SALE SINGLY

On demand may be realised in other finishes of the colour chart. Contact our customer service for minimum quantity, timing and price.

**SKIRTING POLISHED TITANIUM ALUMINIUM**  
thermo packed - bar length 2 lm - pack. 25 Pcs - 50 lm

Article	H mm
PKISPBT 70	70

**SKIRTING POLISHED BRUSHED TITANIUM ALUMINIUM**  
thermo packed - bar length 2 lm - pack. 25 Pcs - 50 lm

Article	H mm
PKISPTS 70	70

UPON REQUEST AVAILABLE IN H 100mm (MINIMUM QUANTITY 200 lm)  
Skirtings in polished brushed titanium aluminium match with capsules and joints in varnished PVC with polished titanium aluminium effect (see below).

COLOURS



**POWER SUPPLY BOX**  
SOCKET with FASTENING BASIS

Article
SPA 1820

**SWITCH BOX**  
with BOX BASIS

Article
SI 1410

**JUNCTION BOX**  
with FASTENING BASIS

Article
SD 1210

**VERTICAL CABLE DUCT PROFILE**  
bar length 2,7 lm

Article
PSPV

It matches with CSPPK 80. Pag. 197.

LAYING INSTRUCTIONS

1. Choose "PROSKIRTING ISP" in the desired finish and height.
2. Fix the punched support to the wall with screws every 50 cm.
3. If expected, laying the low-voltage electric cables like web, computer, telephone and satellite TV.
4. Attach the profile to the support applying low pressure.

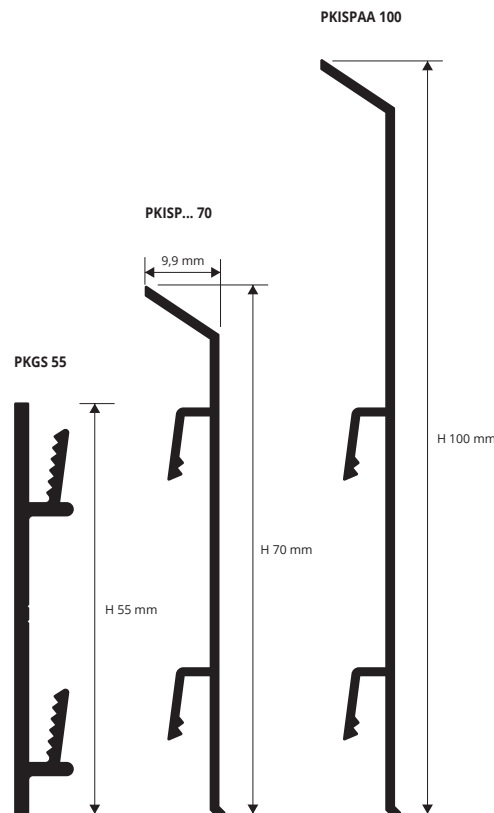

EXAMPLES OF LAYING

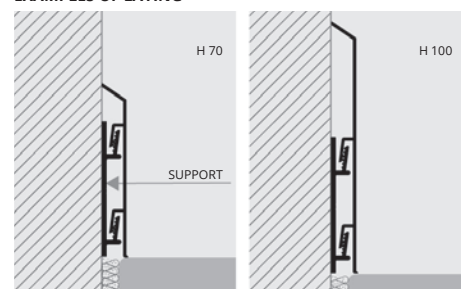

## CORNERS, END CAPS and JOINTS

VARNISHED PLASTIC (finishes anodized silver, polished titanium)

IN/EXTERNAL CORNER - VARNISHED PLASTIC anod. silver - pack. 5 Pcs

Article	H mm
PKIAGI .../5	70/100
PKIAGE .../5	70/100

JOINTS - VARNISHED PLASTIC anod. silver - pack. 10 Pcs

Article	H mm
PKIGIN .../10	70 / 100

END CAPS R / L - VARNISHED PLASTIC ANODIZED silver  
pack. 10 Pcs (5 right and 5 left)

Article	H mm
PKITDSAA .../5	70 / 100

IN/EXTERNAL CORNER - VARNISHED PLASTIC polished titanium - pack. 5 Pcs

Article	H mm
PKIAGIBT 70/5	70
PKIAGEBT 70/5	70

JOINTS - VARNISHED PLASTIC polished titanium - pack. 10 Pcs

Article	H mm
PKIGINBT 70/10	70

END CAPS R / L - VARNISHED PLASTIC poli. titanium - pack. 10 Pcs (5 right and 5 left)

Article	H mm
PKITDSBT 70/5	70

Available on demand aluminium prewelded internal and external flush corners. Price to be agreed. Production delay 4/5 weeks.



PKIAGE.. 70 / 100 external corner



PKIAGI.. 70 / 100 internal corner



PKIGIN.. 70 / 100 joint



PKITDS.. 70 / 100/5 end caps

\* = Production on demand with minimum quantity of 100 Pcs. Production delay 4/5 weeks. Price to be agreed



# PROSKIRTING LIST 40

ANODISED, BRUSHED, VARNISHED ALUMINIUM

PROSKIRTING LIST is a skirting/baseboard profile in different finishes anodized, polished, brushed, varnished aluminium, 40 mm high and 10 mm wide which can be fixed directly to the wall with adhesive (PKLT .. 40A non-inspectable version) or with aluminum supports (inspectable version PKLT .. 40). The aluminum supports, 20 mm long, are fixed with plugs to the wall, every about 50 cm. PROSKIRTING LIST 40 in aluminum is suitable in any indoor environment.

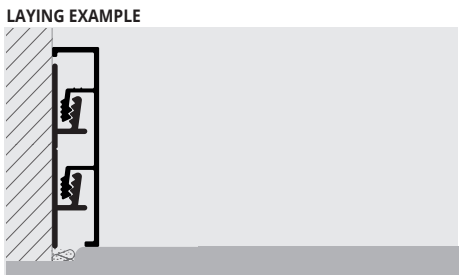
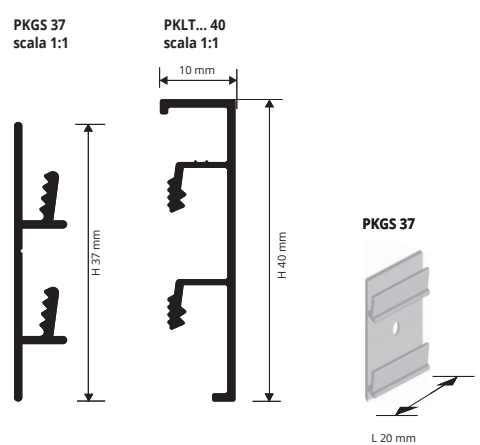

**LAYING INSTRUCTIONS**  
 1. Choose "PROSKIRTING LIST" in the desired finish and height. 2. Fix the punched support to the wall with screws every 50 cm. 3. If expected, laying the low-voltage electric cables like web, computer, telephone and satellite TV. 4. Attach the profile to the support applying low pressure.



PROSKIRTING LIST 40 - ANODISED SILVER ALUMINIUM thermo packed - bar lenght 2 ml - pack. 20 PCS - 40 ml

Article	H mm	€/ml	€/Pcs
PKLTAA 40	40		
PKLTAA 40A	40		

"A" at the end of the product code = Item with adhesive

PROSKIRTING LIST 40 - VARNISHED ALUMINIUM WHITE thermo packed - bar lenght 2 ml - pack. 20 PCS - 40 ml

Article	H mm	€/ml	€/Pcs
PKLTA 40-01	40		
PKLTA 40-01A	40		

"A" at the end of the product code = Item with adhesive

**COLOURS**

01 - Aluminium varnished white	AA - Anodised silver aluminium	BS - Brushed silver aluminium



PROSKIRTING LIST 40 - BRUSHED SILVER ALUMINIUM thermo packed - bar lenght 2 ml - pack. 20 PCS - 40 ml

Article	H mm	€/ml	€/Pcs
PKLTBS 40	40		
PKLTBS 40A	40		

"A" at the end of the product code = Item with adhesive

PUNCHED SUPPORT - Natural aluminium - bar lenght 2 cm - pack. 10 PCS

Article	H mm	€/pack.
PKGS 37	37	

**COLOURS ON DEMAND 100 PCS / 200 LM**

010 - Varnished aluminium matt white	BT - Polished titanium aluminium	TS - Brushed titanium aluminium
RS - Brushed copper aluminium		

## INTERNAL and EXTERNAL CORNERS, END CAPS

ANODISED, BRUSHED AND VARNISHED ALUMINIUM

Internal / external corners  
 REPKLT... 40

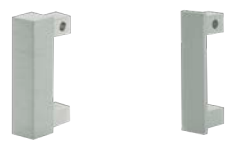

INTERNAL / EXTERNAL CORNER - ANODISED SILVER ALUMINIUM pack. 5 PCS

Article	H mm	€/Pack
REPKLTAA 40/5	40	

INTERNAL / EXTERNAL CORNER - BRUSHED SILVER ALUMINIUM pack. 5 PCS

Article	H mm	€/Pack
REPKLTBS 40/5	40	

INTERNAL / EXTERNAL CORNER - VARNISHED ALUMINIUM WHITE pack. 5 PCS

Article	H mm	€/Pack
REPKLTA 40-01/5	40	

END CAPS - ALL. ANODISED SILVER ALUMINIUM pack. 4/10 PCS

Article	H mm	€/Pack 4 Pcs	€/Pack 10 Pcs
TPKLTAA 40/...	40		

END CAPS - BRUSHED SILVER ALUMINIUM pack. 4/10 PCS

Article	H mm	€/Pack 4 Pcs	€/Pack 10 Pcs
TPKLTBS 40/...	40		

END CAPS - VARNISHED ALUMINIUM WHITE pack. 4/10 PCS

Article	H mm	€/Pack 4 Pcs	€/Pack 10 Pcs
TPKLTAA 40-01/...	40		

Choose the desired packaging.  
 E.g.: TPKLTA... 40/4 (pack. 4 Pcs)  
 TPKLTA... 40/10 (pack. 10 Pcs)





PROSKIRTING LIST is a skirting/baseboard profile in different finishes anodized, polished, brushed, varnished aluminium, 80 mm high and 10 mm wide which can be fixed directly to the wall with adhesive (PKLT .. 80A non-inspectable version) or with aluminum supports (inspectable version PKLT .. 80). The aluminum supports, 20 mm long, are fixed with plugs to the wall, every about 50 cm. PROSKIRTING LIST 80 in aluminum is suitable in any indoor environment.

# PROSKIRTING LIST 80

ANODISED, BRUSHED, VARNISHED ALUMINIUM



PROSKIRTING LIST 80 - ANODISED SILVER ALUMINIUM thermo packed - bar lenght 2 ml - pack. 20 PCS - 40 ml

Article	H mm	€/ml	€/Pcs
PKLTAA 80	80		
PKLTAA 80A	80		

"A" at the end of the product code = Item with adhesive

PROSKIRTING LIST 80 - VARNISHED ALUMINIUM WHITE thermo packed - bar lenght 2 ml - pack. 20 PCS - 40 ml

Article	H mm	€/ml	€/Pcs
PKLTA 80-01	80		
PKLTA 80-01A	80		

"A" at the end of the product code = Item with adhesive

## COLOURS

01 - Aluminium varnished white	AA - Anodised silver aluminium	BS - Brushed silver aluminium

## COLOURS ON DEMAND 100 PCS / 200 LM

010 - Varnished aluminium matt white	BT - Polished titanium aluminium	TS - Brushed titanium aluminium	RS - Brushed copper aluminium



PROSKIRTING LIST 80 - BRUSHED SILVER ALUMINIUM thermo packed - bar lenght 2 ml - pack. 20 PCS - 40 ml

Article	H mm	€/ml	€/Pcs
PKLTBS 80	80		
PKLTBS 80A	80		

"A" at the end of the product code = Item with adhesive

PUNCHED SUPPORT - Natural aluminium - bar lenght 2 cm - pack. 10 PCS

Article	H mm	€/pack.
PKGS 55	55	

## EXAMPLE FOR THE LAYING

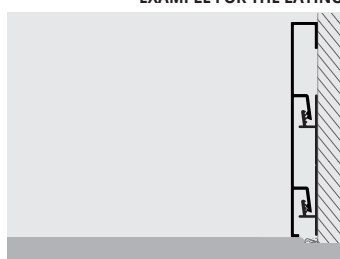

PKALA 80.. scale 1:1

PKGS 55 scale 1:1

PKGS 55

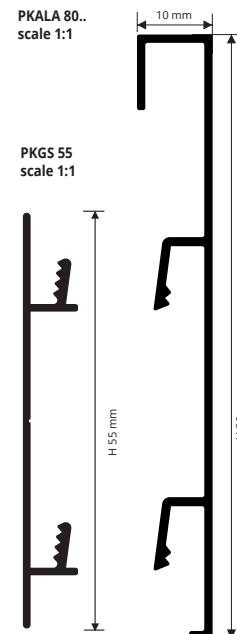
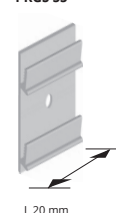

## ISTRUZIONI TECNICHE DI POSA

1. Choose "PROSKIRTING LIST" in the desired finish and height.
2. Fix the punched support to the wall with screws every 50 cm.
3. If expected, laying the low-voltage electric cables like web, computer, telephone and satellite TV.
4. Attach the profile to the support applying low pressure.

# INTERNAL and EXTERNAL CORNERS, END CAPS

ANODISED, BRUSHED AND VARNISHED ALUMINIUM

INTERNAL / EXTERNAL CORNER - ANODISED SILVER ALUMINIUM pack. 5 PCS

Article	H mm	€/pack.
REPKLTA 80/5	80	

INTERNAL / EXTERNAL CORNER - BRUSHED SILVER ALUMINIUM pack. 5 PCS

Article	H mm	€/pack.
REPCLTBS 80/5	80	

INTERNAL / EXTERNAL CORNER - VARNISHED ALUMINIUM WHITE pack. 5 PCS

Article	H mm	€/pack.
REPKLTA 80-01/5	80	

END CAPS - ALL. ANODISED SILVER ALUMINIUM pack. 4/10 PCS

Article	H mm	€/pack. 4 Pcs	€/pack. 10 Pcs
TPKLTA 80/...	80		

END CAPS - BRUSHED SILVER ALUMINIUM pack. 4/10 PCS

Article	H mm	€/pack. 4 Pcs	€/pack. 10 Pcs
TPCLTBS 80/...	80		

END CAPS - VARNISHED ALUMINIUM WHITE pack. 4/10 PCS

Article	H mm	€/pack. 4 Pcs	€/pack. 10 Pcs
TPKLTA 80-01/...	80		

Choose the desired packaging.  
E.g.: TPKLTA... 80/4 (pack. 4 Pcs)  
TPKLTA... 80/10 (pack. 10 Pcs)

End caps TPKLT... 80



Internal / external corners REPKLT... 80



\* = Production on demand with minimum quantity of 100 pcs. Production delay 4/5 weeks. Price to be agreed



**PROSKIRTING LED** is an innovative patented baseboard called "cable duct" in anodized aluminium, with illumination led system incorporated. Conceived and designed to illuminate the passage zone such as corridors and house and office entrances as well. It generates soft and indirect light. Moreover, it solves many other problems such as the laying of the baseboard itself, the passage of the electric cables, the ones for PC, telephone and other plants as well. **PROSKIRTING LED** has been designed with double function and utility: 1- **PROSKIRTING LED** complete PKLEDAA 80 is an inspectional joint baseboard composed of PKGS 66 support for fixing it with screws on the wall and the **PROSKIRTING LED** PKLEDAA 80 at sight profile. 2- **PROSKIRTING LED** PKLEDAA 80 is a at sight baseboard profile to be fixed directly with silicone/ adhesive. It is not an inspectional one like **PROSKIRTING LED** complete, and is available also in auto adhesive version (PKLEDAA 80A).

# PROSKIRTING LED

ANODIZED SILVER ALUMINIUM WITH LED AND POWER SUPPLY BOX



**SKIRTING BOARD IN ANOD. SILVER ALU. WITHOUT ADHESIVE. ADAPTOR LED, LED & FLAT NOT INCLUDED (indicate the article) thermo packed - bar length 2 lm - pack. 10 Pcs - 20 lm**

Article	H mm
PKLEDAA 80	80

**SKIRTING BOARD IN ANOD. SILVER ALUM. WITH ADHESIVE, ADAPTOR LED, LED & FLAT NOT INCLUDED (indicate the article) thermo packed - bar length 2 lm - pack. 10 Pcs - 20 lm**

Article	H mm
PKLEDAA 80A	80

Please, specify in your order the code of the FLAT you choose : matt or gloss. Eg.: PKLEDAA 80 + PKGPIAL

**POLYCARBONATE FLAT - bar length 2 lm**

Article
PKGPIAL
PKGPIAO

**ADHESIVE FLEXIBLE LED COIL**

length 5 lm - pack.1 ROLL

Article
LEDN
LEDF
LEDC

"N" at the end of the product code = neutral light

"F" at the end of the product code = cold light

"C" at the end of the product code = hot light

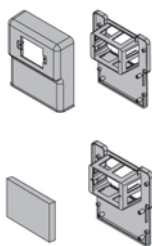

**POWER SUPPLY BOX**

SOCKET with FASTENING BASIS

Article
SPA 1820

**LED POWER SUPPLY 75W - 12V**

Article
ALL 7512

**CABLE RACEWAY/ SUPPORT- COEXTRUDED PVC**  
bar length 2 lm - pack. 20 Pcs - 40 lm

Article	H mm
CSPPK 80	70

**PUNCHED SUPPORT - NATURAL ALUMINIUM**  
support length 2 cm - pack. 10 Pcs

Article	H mm
PKGS 66	66

ARTICLES NOT FOR SALE SINGLY

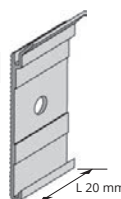

**COLOURS**



On demand may be realised in other finishes of the colour chart. Contact our customer service for minimum quantity, timing and price.

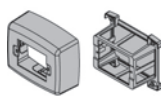

**SWITCH BOX**

with BOX BASIS

Article
SI 1410

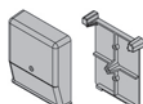

**JUNCTION BOX**

with FASTENING BASIS

Article
SD 1210



**VERTICAL CABLE DUCT PROFILE**

bar length 2,7 lm

Article
PSPV

It matches with CSPPK 80.

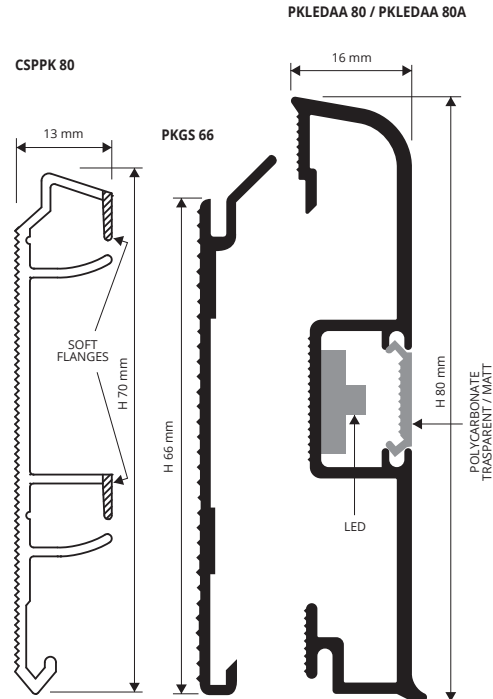

**EXAMPLES AND INSTRUCTIONS FOR LAYING METHODS**

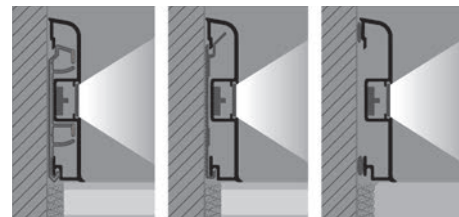

1. Fix the support one the wall putting the screws and plugs every 50 cm (recommended). Make a test with "PROSKIRTING LED" in order to value the height and the correct position of supports.
2. Fix in the chosen spaces the socket/ power supply box basis, switch box basis and, eventually, the junction box.
3. Connect 220V supply to power/ transformer unit, and afterwards, connect the "PROSKIRTING LED" bar next to power unit.
4. Connect the pre-applied led bars inside the "PROSKIRTING LED" with the supplied cables/ wires in continuous way.
5. The power supply unit guarantees about 15 lm of led illumination, beyond that distance it is necessary to add another power supply box/socket.

When fixing without support, clean the surface carefully so that it's dry and with no grass trace, apply the silicone on the knurled sides of the profile and lay down correctly, pressing uniformly and with no hammering. For the application of "PROSKIRTING LED" with adhesive, we recommend the temperature not below 15°.

## CORNERS, END CAPS and JOINTS

VARNISHED PLASTIC SILVER FINISH



PKAGI 80  
internal corner



PKAGE 80  
external corner



PKGIN 80  
joint

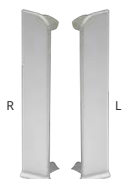

PKTDSAA 80/5  
end caps

**IN/EXTERNAL CORNER - VARNISHED PLASTIC (SILVER FIN.)**  
pack. 5 Pcs

Article	H x L mm
PKAGI 80/5	80 X 40
PKAGE 80/5	80 X 40

**JOINTS - VARNISHED PLASTIC (SILVER FIN.) - pack. 10 Pcs**

Article	H mm
PKGIN 80/10	80

**END CAPS R / L - VARNISHED PLASTIC (SILVER FIN.)**

pack. 10 Pcs (5 right and 5 left)

Article	H mm
PKTDSAA 80/5	80



\* = Production on demand with minimum quantity of 100 Pcs. Production delay 4/5 weeks. Price to be agreed



**PROSKIRTING GILED** is an innovative profile in silver anodized aluminum and polished chrome, with 80 and 100 mm height, with a rigid vinyl resin TOP PROFILE, with a 17,5mm exposed surface, available in 9 different marmorised finishes, provided with an integrated LED lighting system generating a soft and indirect light. **PROSKIRTING GILED** can be used instead of the classic skirting board or rotated 180 degrees and installed along the ceiling edges, allowing to cover up to 15mm wide joints. The reflection of the LED light by the aluminum surface of the profile creates a modern atmosphere. **PROSKIRTING GILED** is equipped with all the trim pieces available such as inside and outside corner, joints, end caps and power supply box. *Conceived and designed by the designer Gilberto Toneguzzi.*

# PROSKIRTING GILED

ANODIZED ALUMINIUM  
POLISHED ALUMINIUM



**SKIRTING H 80 mm IN ANOD. SILVER, POLI. CHROME ALUM.**  
TOP PROFILE NOT INCLUDED (indicate the article)  
thermo packed - bar length 2 lm - pack. 20 Pcs - 40 lm

Article	H mm		
PKGLEDA 80	80		
PKGLEDBC 80	80		*
PKGLEDA 80A	80		
PKGLEDBC 80A	80		*
PKGLEDA 80F	80		*
PKGLEDBC 80F	80		*

**SKIRTING H 100 mm IN ANOD. SILVER, POLI. CHROME ALUM.**  
TOP PROFILE NOT INCLUDED (indicate the article)  
thermo packed - bar length 2 lm - pack. 20 Pcs - 40 lm

Article	H mm		
PKGLEDA 100	100		
PKGLEDBC 100	100		*
PKGLEDA 100A	100		
PKGLEDBC 100A	100		*
PKGLEDA 100F	100		*
PKGLEDBC 100F	100		*

"A" at the end of the product code = Item with adhesive  
"F" at the end of the product code = Punched Item

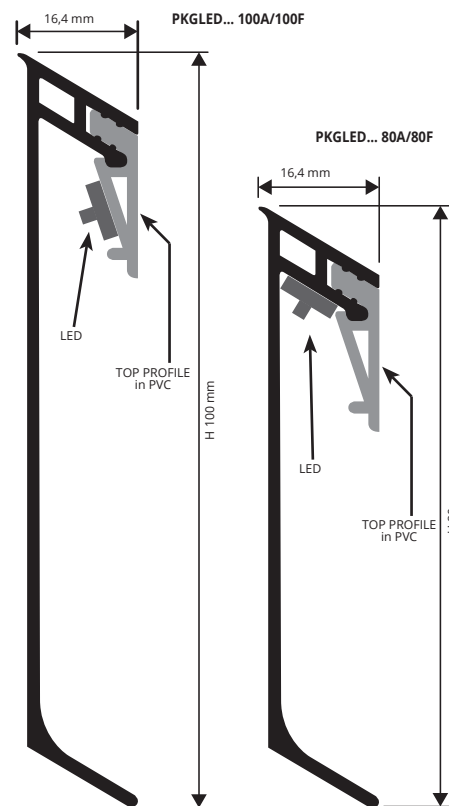

"F" at the end of the product code = Punched Item

USE PROBAND FIX FOR FIXING THE PROFILE TO THE WALL



TOP PROFILE IN PVC - bar length 2 lm

Article	
TOPPKGL...	

In the order specify the chosen colour of the TOP PROFILE.  
E.g. TOPPKGL... (colour gold) TOPPKGLMBO.

Specify the chosen colour of the PVC TOP PROFILE (see below).

PVC TOP PROFILE COLOURS



On demand may be realised in other finishes of the colour chart. Contact our customer service for minimum quantity, timing and price.

SKIRTING COLOURS



ADHESIVE FLEXIBLE LED COIL

length 5 lm - pack.1 ROLL

Article	
LEDN	
LEDF	
LEDC	

"N" at the end of the product code = neutral light  
"F" at the end of the product code = cold light  
"C" at the end of the product code = hot light

LED ADAPTOR AC/DC 75W - 12V (15 lm)  
LED ADAPTOR AC/DC 25W - 12V (5 lm)

Article	
ALL 7512	
ALL 2512	

EXAMPLES AND INSTRUCTIONS FOR LAYING METHODS

1. Choose "PROSKIRTING GILED" depending on the desired finish and fixing system; 2. If you are installing the version with adhesive: clean the surface on which the profile is to be laid, ensuring that it is dry. Remove the protective film and place the profile, applying adequate pressure on it. If you are installing the punched version, drill the surface on which the profile is to be laid using a drill with 5mm diameter and insert the 5x 25mm screws. Screw the profile; 3. Connect the 12/24 V adaptor; 4. Fix the LED light to the inclined side of the aluminum profile or to the vinyl resin support and install electrical wiring; 5. Apply the rigid vinyl resin insert to the aluminum profile.



## CORNERS, END CAPS and JOINTS

VARNISHED PLASTIC

**FLUSH CORNERS** - varnished plastic

IN/EXTERNAL CORNER - FLUSH CORNERS

VARNISHED PLASTIC ANOD. SILVER, POLI. CHROME - pack. 5 Pcs

Article	H x L mm	
REPKGLEDA 80/5	80 x 10	
RIPKGLEDA 80/5	80 x 10	
REPKGLEDBC 80/5	80 x 10	*
RIPKGLEDBC 80/5	80 x 10	*

FLUSH JOINT - VARNISHED PLASTIC ANOD. SILVER, POLI. CHROME  
pack. 5 Pcs

Article	H mm	
GIPKGLEDA 80/5	80	
GIPKGLEDBC 80/5	80	*

FLUSH END CAPS R / L - VARNISHED PLASTIC ANOD. SILVER,  
POLI. CHROME - pack. 6 Pcs (3 right and 3 left)

Article	H mm	
TPKGLEDA 80/3	80	
TPKGLEDBC 80/3	80	*

**FLUSH CORNERS** - varnished plastic

IN/EXTERNAL CORNER - FLUSH CORNERS

VARNISHED PLASTIC ANOD. SILVER, POLI. CHROME - pack. 5 Pcs

Article	H x L mm	
REPKGLEDA 100/5	100 x 10	
RIPKGLEDA 100/5	100 x 10	
REPKGLEDBC 100/5	100 x 10	*
RIPKGLEDBC 100/5	100 x 10	*

FLUSH JOINT - VARNISHED PLASTIC ANOD. SILVER, POLI. CHROME  
pack. 5 Pcs

Article	H mm	
GIPKGLEDA 100/5	100	
GIPKGLEDBC 100/5	100	*

FLUSH END CAPS R / L - VARNISHED PLASTIC ANOD. SILVER,  
POLI. CHROME - pack. 6 Pcs (3 right and 3 left)

Article	H mm	
TPKGLEDA 100/3	100	
TPKGLEDBC 100/3	100	*

INTERNAL CORNER  
RIPKGLE... 80/100



JOINT  
GIPKGLE... 80/100



EXTERNAL CORNER  
REPKGLE... 80/100



END CAPS  
TPKGLE... 80/100



\* = Production on demand with minimum quantity of 100 Pcs. Production delay 4/5 weeks. Price to be agreed

# PROSKIRTING

ANODIZED SILVER ALUMINIUM

**PROSKIRTING** is an innovative patented "cable channel" skirting in anodized aluminium. Studied and designed to resolve various problems related to the installation of skirting and to the laying of electrical, computer and telephone cables and other service systems. **PROSKIRTING** has been designed to offer a dual function: 1- **PROSKIRTING** complete PKAA 80 is a snap-on inspectable skirting consisting of a support PKGS 66 to be screwed to the wall and the visible profile **PROSKIRTING** PKAA 80. 2- **PROSKIRTING** PKAA 80 is the visible skirting profile to be fixed directly with silicone/adhesive. It is not inspectable like **PROSKIRTING** complete; it is also available in a self-adhesive version (PKAA 80A).

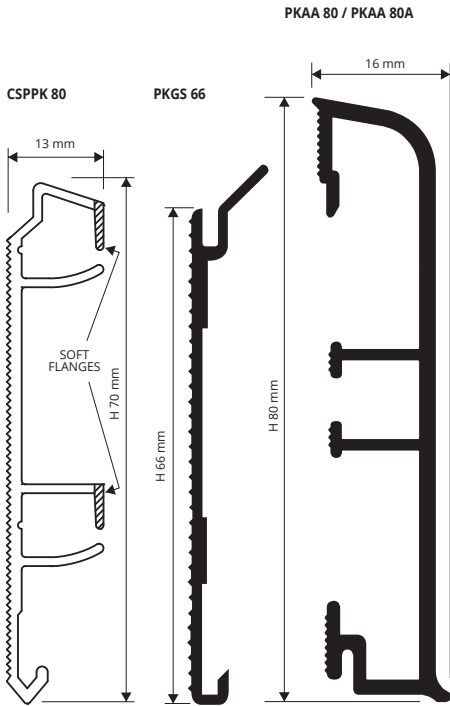

**ONLY SKIRTING (for sale singly) - ANODIZED SILVER ALUMINIUM thermo packed - bar length 2 lm - pack. 10 Pcs - 20 lm**

Article	H mm
PKAA 80	80
PKAA 80A	80

"A" at the end of the product code = Item with adhesive

USE PROBAND FIX FOR FIXING THE PROFILE TO THE WALL



- Advantages:** profile to be glued. Aesthetically superior thanks to the HI-TECH design with rounded shell-shape top and bottom edges that are easy to clean. PROSKIRTING is made in anodized aluminium with silver finish; the anodizing layer is approx. 15/20 micron. Recommended for indoor and outdoor use thanks to its good anti-oxidation properties.
- Single visible skirting profile, which may be inspectable or fixed.
  - Minimum stock investment with just 2 products for three functions.
  - Easy to install and clean.
  - Patented innovative HI-TECH design.
  - Inside-outside corners-end caps and joints varnished in the same finish as the profile.
  - The PROSKIRTING profile is antistatic and stops electromagnetic and electrostatic discharge.

## EXAMPLES AND INSTRUCTIONS FOR LAYING METHODS

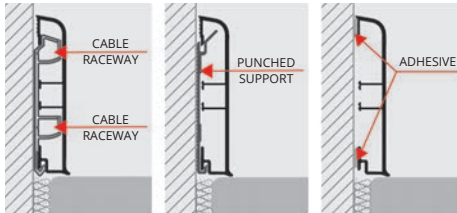

1. Choose the system with or without support
  2. Fix the support to the wall with screws and screw anchors at 50 cm intervals (recommended).
  3. When laying without support, thoroughly clean the surface ensuring that it is grease-free and dry, apply the silicone on the knurled sides of the profiles and lay correctly by applying pressure evenly over the whole profile without using a hammer.
  4. For the "PROSKIRTING" with adhesive, application is recommended at a temperature of at least 15°.
- Always use the inside/outside corner linking elements and end caps for impeccable, faultless laying.

**CABLE RACEWAY/ SUPPORT- COEXTRUDED PVC bar length 2 lm - pack. 20 Pcs - 40 lm**

Article	H mm
CSPPK 80	

**PUNCHED SUPPORT - NATURAL ALUMINIUM support length 2 cm - pack. 10 Pcs**

Article	H mm
PKGS 66	66

ARTICLES NOT FOR SALE SINGLY

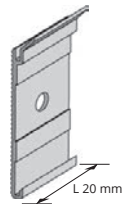

## COLOURS



AA - Anodized silver alum.

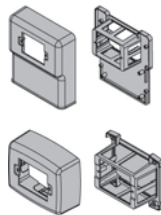

**POWER SUPPLY BOX SOCKET with FASTENING BASIS**

Article	H mm
SPA 1820	

**SWITCH BOX with BOX BASIS**

Article	H mm
SI 1410	

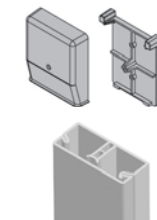

**JUNCTION BOX with FASTENING BASIS**

Article	H mm
SD 1210	

**VERTICAL CABLE DUCT PROFILE bar length 2,7 lm**

Article	H mm
PSPV	

It matches with CSPPK 80

# CORNERS, END CAPS and JOINTS

VARNISHED PLASTIC SILVER FINISH.

**IN/EXTERNAL CORNER - VARNISHED PLASTIC (silver finish.) pack. 5 Pcs**

Article	H x L mm
PKAGI 80/5	80 x 40
PKAGE 80/5	80 x 40

**JOINTS - VARNISHED PLASTIC (silver finish.) - pack. 10 Pcs**

Article	H mm
PKGIN 80/10	80

**END CAPS R / L - VARNISHED PLASTIC (silver finish.)**

pack. 10 Pcs (5 right and 5 left)

Article	H mm
PKTDSAA 80/5	80



PKAGI 80 internal corner



PKAGE 80 external corner



PKGIN 80 JOINT



PKTDSAA 80/5 end caps



PKAGE 80 external corner



PKAGI 80 internal corner



PKGIN 80 joint



PKTDSAA 80/5 end caps



**PROSKIRTING 40** is an anodized silver aluminium skirting profile, with a height of 40 mm. It can be fixed directly to the wall with adhesive (non-inspectionable adhesive version PKAA 40A) or to a support (inspectionable version PKAA 40) in punched aluminum, pieces 20 mm long to be fixed to the wall with screws, every about 50 cm.

# PROSKIRTING 40

ANODIZED SILVER ALUMINIUM



**SKIRTING - SILVER ANODIZED ALUMINIUM thermo packed**  
bar length 2 lm - pack. 20 Pcs - 40 ml

Article	H mm
PKAA 40	40
PKAA 40A	40

\*"A" at the end of the product code = Item with adhesive

**PUNCHED SUPPORT - NATURAL ALUMINIUM**

support length 2 cm - pack. 10 Pcs

Article	H mm	It matches with PKAA 40
PKGS 37	37	

**COLOURS**

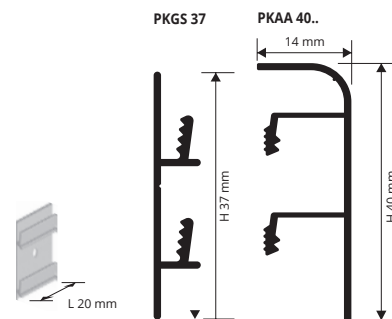
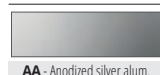

## CORNERS, END CAPS and JOINTS

VARNISHED PLASTIC (SILVER FINISH)

**IN/EXTERNAL CORNERS - VARNISHED PLASTIC (silver finish.)**

pack. 5 Pcs

Article	H mm
PKAGI 40/5	40
PKAGE 40/5	40

**JOINTS - VARNISHED PLASTIC (silver finish.) - pack. 10 Pcs**

Article	H mm
PKGIN 40/10	40

**END CAPS R / L - VARNISHED PLASTIC (silver finish.) - pack. 10 Pcs (5 right and 5 left)**

Article	H mm
PKTDSAA 40/5	40



PKAGI 40 internal corner



PKAGE 40 external corner



PKGIN 40 joint

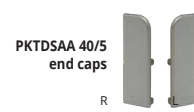

PKTDSAA 40/5 end caps

**PROSKIRTING SHELL** is an innovative aluminum skirting board, with 70mm height, in silver anodized finish. The skirting board can be fixed to the wall with silicone or screwed to 20mm long aluminum punched flanges, that have to be fastened to the wall at 50cm distance from each other. It allows to cover up to 25mm high perimeter edges. Moreover the version with punched flanges allows the housing of low tension electrical cables, such as internet, phone, TV and satellite cables and can be easily inspected. The optional completing pieces, such as inside/outside corners, linking elements and end caps make **PROSKIRTING SHELL** easy to install and guarantee a practical and elegant end result.

# PROSKIRTING SHELL

ANODIZED SILVER ALUMINIUM



**SKIRTING - ANODIZED SILVER ALUMINIUM thermo packed**  
bar length 2 lm - pack. 25 Pcs - 50 lm

Article	H mm
PKSHAA 70	70
PKSHAA 70A	70

\*"A" at the end of the product code = Item with adhesive

**USE PROBAND FIX FOR FIXING THE PROFILE TO THE WALL**



**COLOURS**

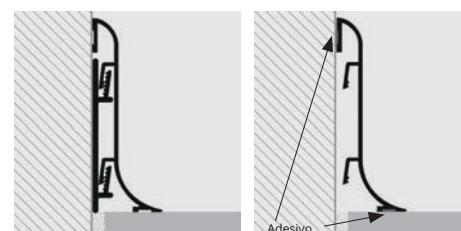
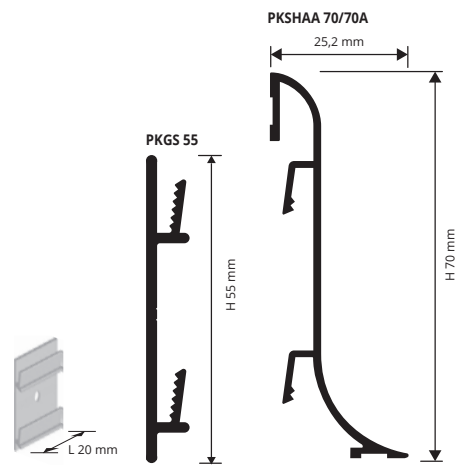

**EXAMPLES AND INSTRUCTIONS FOR LAYING METHODS**

1. Choose the right version of "PROSKIRTING SHELL" depending on the desired fixing solution; 2. If you want to build low tension electrical cables (e.g. internet, phone, TV and satellite cables) into the profile, fasten the punched flanges to the wall using dowels at 50cm distance from each other; 3. Install electrical wiring and fasten "PROSKIRTING SHELL" to the flanges; 4. If you are installing the version with adhesive, first clean and the surface where the profile will be installed, then apply the silicone once the surface is dry. Remove the protective film and lay the profile, applying adequate pressure on it.

## CORNERS, END CAPS and JOINTS

VARNISHED PLASTIC (SILVER FINISH)

**EDGE COVER CORNERS**

**IN/EXTERNAL CORNER - EDGE COVER**

VARNISHED PLASTIC (silver finish.) - pack. 5 Pcs

Article	H x L mm
RIPKSHAA 70/5	70 x 20
REPKSHAA 70/5	70 x 20

**JOINT - EDGE COVER - VARNISHED PLASTIC (silver finish.)**

pack. 5 Pcs

Article	H mm
GIPKSHAA 70/5	70

**END CAPS R / L - EDGE COVER**

VARNISHED PLASTIC (silver finish.) - pack. 6 Pcs (3 right and 3 left)

Article	H mm
TPKSHAA 70/3	70

**EXTERNAL CORNER**  
REPKSHAA 70



**INTERNAL CORNER**  
RIPKSHAA 70



**JOINT**  
GIPKSHAA 70



**END CAPS**  
TPKSHAA 70







# SKIRTING 40

POLISHED AND BRUSHED  
STAINLESS STEEL AISI 304/1.4301-V2A

**SKIRTING 40** made in stainless steel AISI 304/1.4301-V2A in height 40 mm. Available with or without adhesive. Superior aesthetic quality, extremely strong and easy to lay, it is ideal for all public and private environments that require high standards of hygiene and image. Used increasingly more often in contrast combinations with wood, carpeted floors, etc. for an unmistakable hi-tech effect. In order to facilitate and to perfect the laying process, internal and external angles, plugs and junctions are recommended.

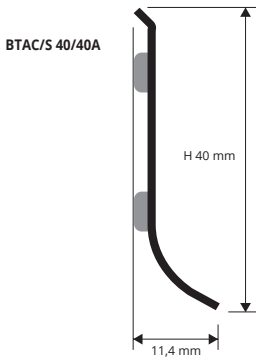

**POLISHED STAINLESS STEEL AISI 304/1.4301-V2A**  
with protective film - bar length 2 lm - pack. 25 Pcs - 50 lm

Article	H mm		
BTAC 40A	40		
BTAC 40	40		

"A" at the end of the product code = Item with adhesive

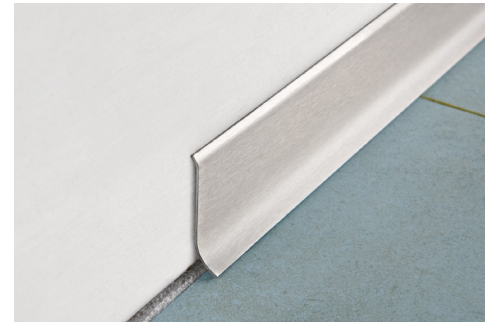

**BRUSHED STAINLESS STEEL AISI 304/1.4301-V2A**  
with protective film - bar length 2 lm - pack. 25 Pcs - 50 lm

Article	H mm		
BTACS 40A	40		
BTACS 40	40		

"A" at the end of the product code = Item with adhesive

## EXAMPLES OF LAYING



## SUITABLE FOR USE IN CONTACT WITH FOODSTUFFS

### LAYING INSTRUCTIONS

1. Choose the "SKIRTING 40" also choose with or without adhesive.
2. Cut the profile to the required length, taking care to calculate the width of the inside-outside corner joints.
3. For the self-adhesive version, the surface must be smooth, grease-free and not porous. It is not recommended for plaster and mortar surfaces (version without adhesive is better, using fast-setting acrylic silicone which is suitable for fixing aluminium to mortar - plaster, etc.).
4. Use the corner linking elements-joints and right and left end caps to facilitate laying.

### COLOURS



### USE PROBAND FIX FOR FIXING THE PROFILE TO THE WALL



# CORNERS, END CAPS AND JOINTS

STEEL and VARNISHED METAL

### EDGE COVER VARNISHED METAL



RIZCT... 40/...  
Internal corner



REZCT... 40/...  
external corner



GIZCT... 40/...  
joint



TPZCT... 40/...  
end caps

### PRE-WELDED

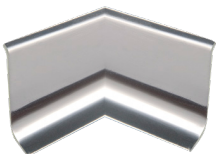

RI... 40/...  
internal corner

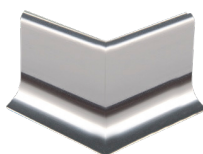

RE... 40/...  
external corner

### VARNISHED METAL - EDGE COVER CORNERS - articles not for sale singly

#### INTERNAL/EXTERNAL CORNER - EDGE COVER VARNISHED METAL POLISHED STEEL EFFECT

Article	HxL mm	pack. 2Pcs	pack. 5Pcs
RIZCTAC 40/...	40 x 20		
REZCTAC 40/...	40 x 20		

#### JOINT - EDGE COVER VARNISHED METAL POLISHED STEEL EFFECT

Article	HxL mm	pack. 2Pcs	pack. 5Pcs
GIZCTAC 40/...	40		

Choose the desired packaging.  
E.g.: RIZCTAC 40/2 (pack. 2 Pcs) - RIZCTAC 40/5 (pack. 5 Pcs)

#### END CAPS R / L - EDGE COVER - VARNISHED METAL POLISHED STEEL EFFECT - pack. 4Pcs (2 R + 2 L) / 10Pcs (5 R + 5 L)

Article	H mm	pack. 4Pcs	pack. 10Pcs
TPZCTAC 40/...	40		

Choose the desired packaging.  
E.g.: TPCCTAC 40/2 (pack. 4 Pcs: 2 right + 2 left)  
TPCCTAC 40/5 (pack. 10 Pcs: 5 right + 5 left)

#### INTERNAL/EXTERNAL CORNER - EDGE COVER VARNISHED METAL BRUSHED STAINLESS ST. EFFECT

Article	HxL mm	pack. 2Pcs	pack. 5Pcs
RIZCTACS 40/...	40 x 20		
REZCTACS 40/...	40 x 20		

#### JOINT - EDGE COVER VARNISHED METAL BRUSHED STAINLESS ST. EFFECT

Article	H mm	pack. 2Pcs	pack. 5Pcs
GIZCTACS 40/...	40		

Choose the desired packaging.  
E.g.: RIZCTACS 40/2 (pack. 2 Pcs) - RIZCTACS 40/5 (pack. 5 Pcs)

#### END CAPS R / L - EDGE COVER - VARNISHED METAL BRUSHED STAINLESS ST. EFFECT - pack. 4Pcs (2 R + 2 L) / 10Pcs (5 R + 5 L)

Article	H mm	pack. 4Pcs	pack. 10Pcs
TPZCTACS 40/...	40		

Choose the desired packaging.  
E.g.: TPCCTACS 40/2 (pack. 4 Pcs: 2 right + 2 left)  
TPCCTACS 40/5 (pack. 10 Pcs: 5 right + 5 left)

### STEEL AISI 304/1.4301-V2A - FLUSH CORNERS - articles not for sale singly

#### INTERNAL/EXTERNAL CORNER FLUSH PRE-WELDED - POLISHED STEEL EFFECT

Article	HxL mm	pack. 2Pcs	pack. 5Pcs
RIAC 40/...	40 x 50		
REAC 40/...	40 x 50		

Choose the desired packaging.  
E.g.: RIAC 40/2 (pack. 2 Pcs) - RIAC 40/5 (pack. 5 Pcs)

#### INTERNAL/EXTERNAL CORNER FLUSH PRE-WELDED - BRUSHED STAINLESS STEEL

Article	HxL mm	pack. 2Pcs	pack. 5Pcs
RIACS 40/...	40 x 50		
REACS 40/...	40 x 50		

Choose the desired packaging.  
E.g.: RIACS 40/2 (pack. 2 Pcs) - RIACS 40/5 (pack. 5 Pcs)

**SKIRTING 40** made in anodized, polished and brushed aluminium in height 40 mm. Available with or without adhesive. Superior aesthetic quality and easy to lay, it is ideal for all public and private environments. Can be used with all types of flooring. In order to facilitate and to perfect the laying process, internal and external angles, plugs and junctions are recommended. Please contact the technical department for informations concerning the skirting bending radius.

# SKIRTING 40

ANODIZED, POLISHED, VARNISHED and BRUSHED ALUMINIUM



**ANODIZED SILVER ALUMINIUM thermo packed**  
bar length 2 lm - pack. 40 Pcs - 80 lm

Article	H mm
BTAA 40A	40
BTAA 40	40

"A" at the end of the product code = Item with adhesive  
**POLISHED TITANIUM ALUMINIUM thermo packed**  
bar length 2 lm - pack. 40 Pcs - 80 lm

Article	H mm
BTBT 40A	40
BTBT 40	40

"A" at the end of the product code = Item with adhesive  
**VARNISHED SEMIGLOSSY AND MATT WHITE ALUMINIUM thermo packed** - bar length 2 lm - pack. 40 Pcs - 80 lm

Article	H mm
BTA 40-01A	40
BTA 40-01	40
BTA 40-01OA	40
BTA 40-01O	40

"A" at the end of the product code = Item with adhesive

**BRUSHED ALUMINIUM (silver-copper-titanium) thermo packed** - bar length 2 lm - pack. 40 Pcs - 80 lm

Article	H mm
BTBS 40A	40
BTBS 40	40
BTRS 40A	40
BTRS 40	40
BTTS 40A	40
BTTS 40	40

"A" at the end of the product code = Item with adhesive

**STONE LINE ALUMINIUM thermo packed** - bar length 2 lm - pack. 40 Pcs - 80 lm

Article	H mm
BTA 40-SL01A	40
BTA 40-SL01	40
BTA 40-SL08A	40
BTA 40-SL08	40
BTA 40-SL12A	40
BTA 40-SL12	40

"A" at the end of the product code = Item with adhesive

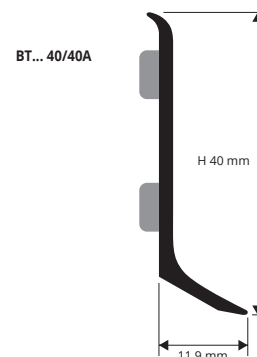

## EXAMPLES AND INSTRUCTIONS FOR LAYING METHODS



1. Choose the "SKIRTING 40" also choose with or without adhesive.
2. Cut the profile to the required length, taking care to calculate the width of the inside-outside corner joints.
3. For the self-adhesive version, the surface must be smooth, grease-free and not porous. It is not recommended for plaster and mortar surfaces (version without adhesive is better, using fast-setting acrylic silicone which is suitable for fixing aluminium to mortar - plaster, etc.).
4. Use the corner linking elements-joints and right and left end caps to facilitate laying.

## COLOURS

ANODIZED		POLISHED		BRUSHED	
AA	BT	BS	RS	TS	ON DEMAND
AA - Anodized silver alum. BT - Polished titanium alum. BS - Brushed silver alum. RS - Brushed copper alum. TS - Brushed titanium alum.					
SEMIGLOSSY		MATT		STONE LINE	
		ON DEMAND	ON DEMAND	ON DEMAND	ON DEMAND
01	01O	SL01	SL08	SL12	
01 - White varnished alum. (9016) 01O - White varnished alum. (9016) SL01 - Stone white SL08 - Stone antradark SL12 - Stone black					

(There aren't combinations for the finish alu. RS)

On demand may be realised in other finishes of the colour chart. Contact our customer service for minimum quantity, timing and price.

## USE PROBAND FIX FOR FIXING THE PROFILE TO THE WALL



# CORNERS, END CAPS AND JOINTS

VARNISHED METAL and VARNISHED PLASTIC

\* Corners, end caps and joints of the on demand profiles are also on demand

**INTERNAL/EXTERNAL CORNER - EDGE COVER - VARNISHED METAL, ANODIZED, POLISHED STONE LINE - H 40 MM - L 20 MM**

Article	pack. 2Pcs	pack. 5Pcs
RIZCTAA 40/...		
REZCTAA 40/...		
RIZCTBT/BS/TS/RS 40/...		
REZCTBT/BS/TS/RS 40/...		
RIZCT01/01O 40/...		
REZCT01/01O 40/...		
RIZCTA 40-SL.../...		
REZCTA 40-SL.../...		

Choose the desired packaging.  
E.g.: RIZCTAA 40/2 (pack. 2 Pcs) - RIZCTAA 40/5 (pack. 5Pcs)

**JOINT - EDGE COVER VARNISHED METAL ANODIZED, POLISHED, STONE LINE**

Article	H mm
GIZCTAA 40/...	40
GIZCTBT/BS/TS/RS 40/...	40
GIZCT01/01O 40/...	40
GIZCTA 40-SL.../...	40

**END CAPS R / L - EDGE COVER - VARNISHED METAL ANODIZED, POLISHED, STONE LINE - pack. 4Pcs (2 R + 2 L) / 10Pcs (5 R + 5 L)**

Article	H mm
TPZCTAA 40/...	40
TPZCTBT/BS/TS/RS 40/...	40
TPZCT01/01O 40/...	40
TPZCTA 40-SL.../...	40

**INTERNAL/EXTERNAL CORNER - EDGE COVER VARNISHED PLASTIC ANODIZED SILVER, POLISHED AND TITANIUM**

Article	HxL mm	pack. 2Pcs	pack. 5Pcs
RICTAA 40/...	40 x 20		
RECTAA 40/...	40 x 20		
RICTBT 40/...	40 x 20		
RECTBT 40/...	40 x 20		

Choose the desired packaging.  
E.g.: RICTAA 40/2 (pack. 2 Pcs) - RICTAA 40/5 (pack. 5 Pcs)

Available on demand aluminium prewelded internal and external flush corners. Finishing: 01 - 01O - AA - BT - BS - RS - TS. Price to be agreed. Production delay 4/5 weeks.

**JOINT - EDGE COVER VARNISHED PLASTIC ANODIZED SILVER, POLISHED AND TITANIUM**

Article	H mm
GICTAA 40/...	40
GICTBT 40/...	40

**END CAPS R / L - EDGE COVER - VARNISHED PLASTIC ANODIZED SILVER, POLISHED AND TITANIUM - pack. 4Pcs (2 R + 2 L) / 10Pcs (5 R + 5 L)**

Article	H mm
TPCTAA 40/...	40
TPCTBT 40/...	40

Choose the desired packaging.  
E.g.: TPCTAA 40/2 (pack. 4 Pcs: 2 right + 2 left)

## METAL EDGE COVER



## PLASTIC EDGE COVER



\*\*\* = Production on demand with minimum quantity of 80 Pcs. Production delay 4/5 weeks. Price to be agreed

\* = Production on demand with minimum quantity of 100 Pcs. Production delay 4/5 weeks. Price to be agreed

News 2021

# SKIRTING 60

POLISHED and Brushed  
STAINLESS STEEL AISI 304/1.4301-V2A

**SKIRTING 60** made in stainless steel AISI 304/1.4301-V2A in height 60 mm. Available with or without adhesive. Superior aesthetic quality, extremely strong and easy to lay, it is ideal for all public and private environments that require high standards of hygiene and image. Used increasingly more often in contrast combinations with wood, carpeted floors, etc. for an unmistakable hi-tech effect. In order to facilitate and to perfect the laying process, internal and external angles, plugs and junctions are recommended.

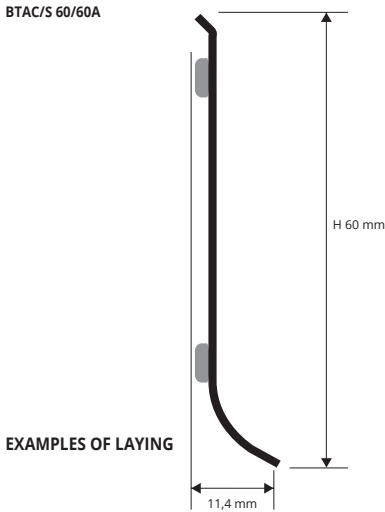

**POLISHED STAINLESS STEEL AISI 304/1.4301-V2**  
with protective film - bar length 2 lm - pack. 25 Pcs - 50 lm

Article	H mm		
BTAC 60A	60		
BTAC 60	60		

"A" at the end of the product code = Item with adhesive



**Brushed STAINLESS STEEL AISI 304/1.4301-V2A**  
with protective film - bar length 2 lm - pack. 25 Pcs - 50 lm

Article	H mm		
BTACS 60A	60		
BTACS 60	60		

"A" at the end of the product code = Item with adhesive

SUITABLE FOR USE IN CONTACT WITH FOODSTUFFS

## LAYING INSTRUCTIONS

1. Choose the "SKIRTING 60" also choose with or without adhesive. 2. Cut the profile to the required length, taking care to calculate the width of the inside-outside corner joints. 3. For the self-adhesive version, the surface must be smooth, grease-free and not porous. It is not recommended for plaster and mortar surfaces (version without adhesive is better, using fast-setting acrylic silicone which is suitable for fixing aluminium to mortar - plaster, etc.). 4. Use the corner linking elements-joints and right and left end caps to facilitate laying.

## COLOURS

AC - Polished stainless steel AISI 304/1.4301-V2A	ACS - Brushed stainless steel AISI 304/1.4301-V2A

USE PROBAND FIX FOR FIXING THE PROFILE TO THE WALL

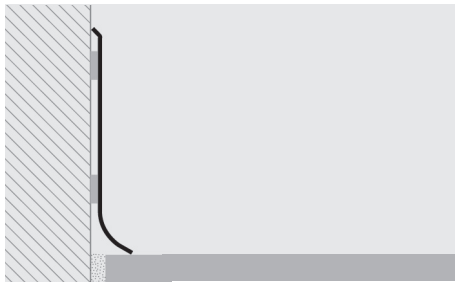

# CORNERS, END CAPS AND JOINTS

STEEL and VARNISHED METAL

## EDGE COVER VARNISHED METAL



RIZCT... 60/...  
internal corner



REZCT... 60/...  
external corner



GIZCT... 60/...  
joint



TPZCT... 60/...  
end caps

## PRE-WELDED

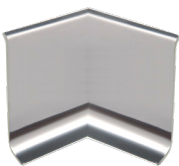

RI...60/...  
internal corner

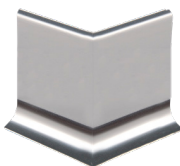

RE... 60/...  
external corner

## VARNISHED METAL - EDGE COVER CORNERS - articles not for sale singly

### INTERNAL/EXTERNAL CORNER - EDGE COVER VARNISHED METAL POLISHED STEEL EFFECT

Article	HxL mm	pack. 2Pcs	pack. 5Pcs
RIZCTAC 60/...	60 x 20		
REZCTAC 60/...	60 x 20		

### JOINT - EDGE COVER VARNISHED METAL POLISHED STEEL EFFECT

Article	H mm	pack. 2Pcs	pack. 5Pcs
GIZCTAC 60/...	60		

Choose the desired packaging.

E.g.: RIZCTAC 60/2 (pack. 2 Pcs) - RIZCTAC 60/5 (pack. 5 Pcs)

### END CAPS R / L - EDGE COVER - VARNISHED METAL POLISHED STEEL EFFECT - pack. 4Pcs (2 R + 2 L) / 10Pcs (5 R + 5 L)

Article	H mm	pack. 4Pcs	pack. 10Pcs
TPZCTAC 60/...	60		

Choose the desired packaging.

E.g.: TPCCTAC 60/2 (pack. 4 Pcs: 2 right + 2 left)  
TPCCTAC 60/5 (pack. 10 Pcs: 5 right + 5 left)

### INTERNAL/EXTERNAL CORNER - EDGE COVER VARNISHED METAL BRUSHED STAINLESS ST. EFFECT

Article	HxL mm	pack. 2Pcs	pack. 5Pcs
RIZCTACS 60/...	60 x 20		
REZCTACS 60/...	60 x 20		

### JOINT - EDGE COVER VARNISHED METAL BRUSHED STAINLESS ST. EFFECT

Article	H mm	pack. 2Pcs	pack. 5Pcs
GIZCTACS 60/...	60		

Choose the desired packaging.

E.g.: RIZCTACS 60/2 (pack. 2 Pcs) - RIZCTACS 60/5 (pack. 5 Pcs)

### END CAPS R / L - EDGE COVER - VARNISHED METAL BRUSHED STAINLESS ST. EFFECT - pack. 4Pcs (2 R + 2 L) / 10Pcs (5 R + 5 L)

Article	H mm	pack. 4Pcs	pack. 10Pcs
TPZCTACS 60/...	60		

Choose the desired packaging.

E.g.: TPCCTACS 60/2 (pack. 4 Pcs: 2 right + 2 left)  
TPCCTACS 60/5 (pack. 10 Pcs: 5 right + 5 left)

## STEEL AISI 304/1.4301-V2A - FLUSH CORNERS - articles not for sale singly

### INTERNAL/EXTERNAL CORNER FLUSH PRE-WELDED - POLISHED STEEL EFFECT

Article	HxL mm	pack. 2Pcs	pack. 5Pcs
RIAC 60/...	60 x 50		
REAC 60/...	60 x 50		

Choose the desired packaging.

E.g.: RIAC 60/2 (pack. 2 Pcs) - RIAC 60/5 (pack. 5 Pcs)

### INTERNAL/EXTERNAL CORNER FLUSH PRE-WELDED - BRUSHED STAINLESS STEEL

Article	HxL mm	pack. 2Pcs	pack. 5Pcs
RIACS 60/...	60 x 50		
REACS 60/...	60 x 50		

Choose the desired packaging.

E.g.: RIACS 60/2 (pack. 2 Pcs) - RIACS 60/5 (pack. 5 Pcs)



**SKIRTING 60** made in anodized, polished and brushed aluminium in height 60 mm. Available with or without adhesive. Superior aesthetic quality and easy to lay, it is ideal for all public and private environments. Can be used with all types of flooring. In order to facilitate and to perfect the laying process, internal and external angles, plugs and junctions are recommended. Please contact the technical department for informations concerning the skirting bending radius.

# SKIRTING 60

ANODIZED, POLISHED, VARNISHED and BRUSHED ALUMINIUM



**ANODIZED SILVER ALUMINIUM thermo packed**  
bar length 2 lm - pack. 40 Pcs - 80 lm

Article	H mm
BTAA 60A	60
BTAA 60	60

"A" at the end of the product code = Item with adhesive

**POLISHED TITANIUM ALUMINIUM thermo packed**  
bar length 2 lm - pack. 40 Pcs - 80 lm

Article	H mm
BTBT 60A	60
BTBT 60	60

"A" at the end of the product code = Item with adhesive

**VARNISHED SEMIGLOSSY AND MATT WHITE ALUMINIUM thermo packed - bar length 2 lm - pack. 40 Pcs - 80 lm**

Article	H mm
BTA 60-01A	60
BTA 60-01	60
BTA 60-010A	60
BTA 60-010	60

"A" at the end of the product code = Item with adhesive

## COLOURS

ANODIZED	POLISHED	BRUSHED	SEMIGLOSSY	MATT	STONE LINE
AA - Anodized silver alum.	BT - Polished titanium alum.	BS - Brushed silver alum.	TS - Brushed copper alum.	01 - White varnished alum. (9016)	010 - White varnished alum. (9016)
				On demand	On demand
				On demand	On demand
				SL01 - Stone white	SL08 - Stone antradrak
					SL12 - Stone black



**BRUSHED ALUMINIUM (silver-copper-titanium) thermo packed - bar length 2 lm - pack. 40 Pcs - 80 lm**

Article	H mm
BTBS 60A	60
BTBS 60	60
BTRS 60A	60
BTRS 60	60
BTTS 60A	60
BTTS 60	60

"A" at the end of the product code = Item with adhesive

## STONE LINE ALUMINIUM

**thermo packed - bar length 2 lm - pack. 40 Pcs - 80 lm**

Article	H mm
BTA 60-SL01A	60
BTA 60-SL01	60
BTA 60-SL08A	60
BTA 60-SL08	60
BTA 60-SL12A	60
BTA 60-SL12	60

"A" at the end of the product code = Item with adhesive

BT... 60/60A

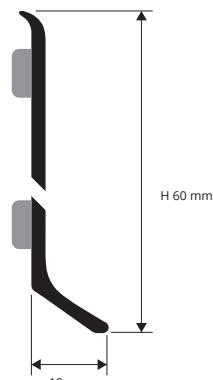

## EXAMPLES AND INSTRUCTIONS FOR LAYING METHODS

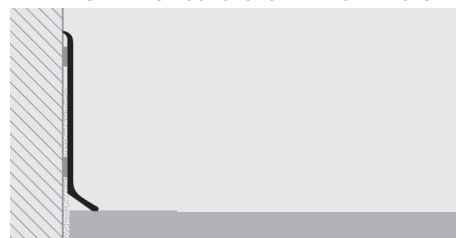

USE PROBAND FIX FOR FIXING THE PROFILE TO THE WALL

# CORNERS, END CAPS AND JOINTS

VARNISHED METAL and VARNISHED PLASTIC

\* Corners, end caps and joints of the on demand profiles are also on demand

**INTERNAL/EXTERNAL CORNER - EDGE COVER - VARNISHED METAL ANODIZED, POLISHED, STONE LINE - H 60 X L 20**

Article
RIZCTAA 60/...
REZCTAA 60/...
RIZCTBT/BS/TS/RS 60/...
REZCTBT/BS/TS/RS 60/...
RIZCT01/010 60/...
REZCT01/010 60/...
RIZCTA 60-SL.../...
REZCTA 60-SL.../...

Choose the desired packaging.  
E.g.: RIZCTAA 60/2 (pack. 2 Pcs) - RIZCTAA 60/5 (pack. 5 Pcs)

## JOINT - EDGE COVER

**VARNISHED METAL ANODIZED, POLISHED, STONE LINE**

Article	H mm
GIZCTAA 60/...	60
GIZCTBT/BS/TS/RS 60/...	60
GIZCT01/010 60/...	60
GIZCTA 60-SL.../...	60

**END CAPS R / L - EDGE COVER - VARNISHED METAL ANODIZED, POLISHED, STONE LINE - pack. 4Pcs (2R+2L) / 10Pcs (5R+5L)**

Article	H mm
TPZCTAA 60/...	60
TPZCTBT/BS/TS/RS 60/...	60
TPZCT01/010 60/...	60
TPZCTA 60-SL.../...	60

Choose the desired packaging.  
E.g.: TPCCTAA 60/2 (pack. 4 Pcs: 2 right + 2 left)

## INTERNAL/EXTERNAL CORNER - EDGE COVER

**VARNISHED PLASTIC ANODIZED SILVER, POLISHED AND TITANIUM**

Article	HxL mm
RICTAA 60/...	60 x 20
RECTAA 60/...	60 x 20
RICTBT 60/...	60 x 20
RECTBT 60/...	60 x 20

## JOINT - EDGE COVER

**VARNISHED PLASTIC ANODIZED SILVER, POLISHED AND TITANIUM**

Article	H mm
GICTAA 60/...	60
GICTBT 60/...	60

**END CAPS R / L - EDGE COVER - VARNISHED PLASTIC ANODIZED SILVER, POLISHED AND TITANIUM - pack. 4Pcs (2R+2L) / 10Pcs (5R+5L)**

Article	H mm
TPCTAA 60/...	60
TPCTBT 60/...	60

## INTERNAL/EXTERNAL CORNER - FLUSH

**VARNISHED PLASTIC ANODIZED SILVER, POLISHED AND TITANIUM**

Article	HxL mm
RIBAA 60/...	60 x 25
REBAA 60/...	60 x 25
RIBBT 60/...	60 x 25
REBBT 60/...	60 x 25

## JOINT - FLUSH

**VARNISHED PLASTIC ANODIZED SILVER, POLISHED AND TITANIUM**

Article	H mm
GIBAA 60/...	60
GIBBT 60/...	60

**END CAPS R / L - FLUSH - VARNISHED PLASTIC ANODIZED SILVER, POLISHED AND TITANIUM - pack. 4Pcs (2R+2L) / 10Pcs (5R+5L)**

Article	H mm
TPBAA 60/...	60
TPBBT 60/...	60

Available on demand aluminium prewelded internal and external flush corners. Finishing: 01 - 010 - AA - BT - BS - RS - TS. Price to be agreed. Production delay 4/5 weeks.

## METAL EDGE COVER



RIZCT... 60/... internal corner

REZCT... 60/... external corner

GIZCT... 60/... joint

TPZCT... 60/... end caps

## PLASTIC EDGE COVER



RICT... 60/... internal corner

RECT... 60/... external corner

GICT... 60/... joint

TPCT... 60/... end caps

## PLASTIC FLUSH

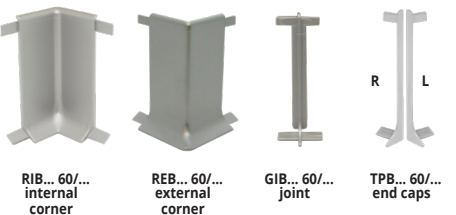

RIB... 60/... internal corner

REB... 60/... external corner

GIB... 60/... joint

TPB... 60/... end caps

\*\* = Production on demand with minimum quantity of 80 Pcs. Production delay 4/5 weeks. Price to be agreed

\* = Production on demand with minimum quantity of 100 Pcs. Production delay 4/5 weeks. Price to be agreed

News 2021

# SKIRTING 80

POLISHED AND BRUSHED  
STAINLESS STEEL AISI 304/1.4301-V2A

**SKIRTING 80** made in stainless steel AISI 304/1.4301-V2A in height 80 mm. Available with or without adhesive. Superior aesthetic quality, extremely strong and easy to lay, it is ideal for all public and private environments that require high standards of hygiene and image. Used increasingly more often in contrast combinations with wood, carpeted floors, etc. for an unmistakable hi-tech effect. In order to facilitate and to perfect the laying process, internal and external angles, plugs and junctions are recommended.

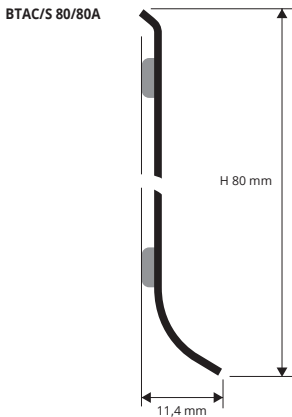

EXAMPLES OF LAYING

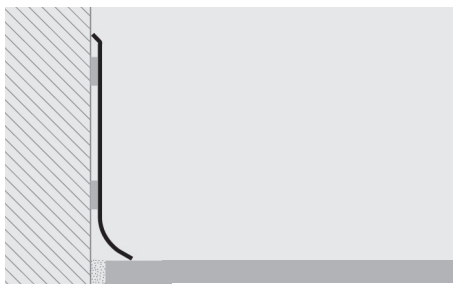

**POLISHED STAINLESS STEEL AISI 304/1.4301-V2**  
with protective film - bar length 2 lm - pack. 25 Pcs - 50 lm

Article	H mm		
BTAC 80A	80		
BTAC 80	80		

"A" at the end of the product code = Item with adhesive

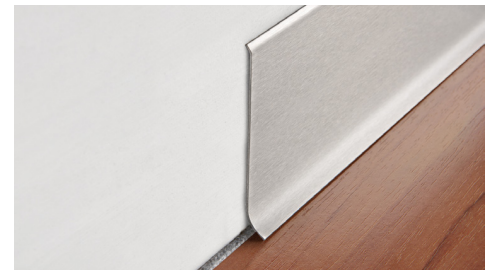

**Brushed STAINLESS STEEL AISI 304/1.4301-V2A**  
with protective film - bar length 2 lm - pack. 25 Pcs - 50 lm

Article	H mm		
BTACS 80A	80		
BTACS 80	80		

"A" at the end of the product code = Item with adhesive

SUITABLE FOR USE IN CONTACT WITH FOODSTUFFS

### LAYING INSTRUCTIONS

1. Choose the "SKIRTING 80" also choose with or without adhesive. 2. Cut the profile to the required length, taking care to calculate the width of the inside-outside corner joints. 3. For the self-adhesive version, the surface must be smooth, grease-free and not porous. It is not recommended for plaster and mortar surfaces (version without adhesive is better, using fast-setting acrylic silicone which is suitable for fixing aluminium to mortar - plaster, etc.). 4. Use the corner linking elements-joints and right and left end caps to facilitate laying.

### COLOURS

	
AC - Polished stainless steel AISI 304/1.4301-V2A	ACS - Brushed stainless steel AISI 304/1.4301-V2A

USE PROBAND FIX FOR FIXING THE PROFILE TO THE WALL



## CORNERS, END CAPS AND JOINTS

STEEL and VARNISHED METAL

### EDGE COVER VARNISHED METAL



RIZCT... 80  
internal corner



REZCT... 80  
external corner



GIZCT... 80  
joint

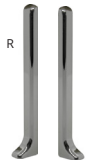

TPZCT... 80/3  
end caps

### PRE-WELDED



RI... 80  
internal corner

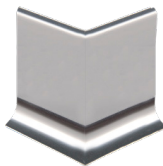

RE... 80  
external corner

### VARNISHED METAL - EDGE COVER CORNERS - articles not for sale singly

#### INTERNAL/EXTERNAL CORNER - EDGE COVER VARNISHED METAL POLISHED STEEL EFFECT

Article	HxL mm	pack. 2Pcs	pack. 5Pcs
RIZCTAC 80/...	80 x 20		
REZCTAC 80/...	80 x 20		

#### JOINT - EDGE COVER VARNISHED METAL POLISHED STEEL EFFECT

Article	H mm	pack. 2Pcs	pack. 5Pcs
GIZCTAC 80	80		

Choose the desired packaging.  
E.g.: RIZCTAC 80/2 (pack. 2 Pcs) - RIZCTAC 80/5 (pack. 5 Pcs)

#### END CAPS R / L - EDGE COVER - VARNISHED METAL POLISHED STEEL EFFECT - pack. 4Pcs (2 R + 2 L) / 10Pcs (5 R + 5 L)

Article	H mm	pack. 4Pcs	pack. 10Pcs
TPZCTAC 80/...	80		

Choose the desired packaging.  
E.g.: TPCCTAC 80/2 (pack. 4 Pcs: 2 right + 2 left)  
TPCCTAC 80/5 (pack. 10 Pcs: 5 right + 5 left)

#### INTERNAL/EXTERNAL CORNER - EDGE COVER VARNISHED METAL BRUSHED STAINLESS ST. EFFECT

Article	HxL mm	pack. 2Pcs	pack. 5Pcs
RIZCTACS 80/...	80 x 20		
REZCTACS 80/...	80 x 20		

#### JOINT - EDGE COVER VARNISHED METAL BRUSHED STAINLESS ST. EFFECT

Article	H mm	pack. 2Pcs	pack. 5Pcs
GIZCTACS 80/...	80		

Choose the desired packaging.  
E.g.: RIZCTACS 80/2 (pack. 2 Pcs) - RIZCTACS 80/5 (pack. 5 Pcs)

#### END CAPS R / L - EDGE COVER - VARNISHED METAL BRUSHED STAINLESS ST. EFFECT - pack. 4Pcs (2 R + 2 L) / 10Pcs (5 R + 5 L)

Article	H mm	pack. 4Pcs	pack. 10Pcs
TPZCTACS 80/...	80		

Choose the desired packaging.  
E.g.: TPCCTACS 80/2 (pack. 4 Pcs: 2 right + 2 left)  
TPCCTACS 80/5 (pack. 10 Pcs: 5 right + 5 left)

### STEEL AISI 304/1.4301-V2A - FLUSH CORNERS - articles not for sale singly

#### INTERNAL/EXTERNAL CORNER FLUSH PRE-WELDED - POLISHED STEEL EFFECT

Article	HxL mm	pack. 2Pcs	pack. 5Pcs
RIAC 80/...	80 x 50		
REAC 80/...	80 x 50		

Choose the desired packaging.  
E.g.: RIAC 80/2 (pack. 2 Pcs) - RIAC 80/5 (pack. 5 Pcs)

#### INTERNAL/EXTERNAL CORNER FLUSH PRE-WELDED - BRUSHED STAINLESS STEEL

Article	HxL mm	pack. 2Pcs	pack. 5Pcs
RIACS 80/...	80 x 50		
REACS 80/...	80 x 50		

Choose the desired packaging.  
E.g.: RIACS 80/2 (pack. 2 Pcs) - RIACS 80/5 (pack. 5 Pcs)



**SKIRTING 80** made in anodized, polished and brushed aluminium in height 80 mm. Available with or without adhesive. Superior aesthetic quality and easy to lay, it is ideal for all public and private environments. Can be used with all types of flooring. In order to facilitate and to perfect the laying process, internal and external angles, plugs and junctions are recommended. Please contact the technical department for informations concerning the skirting bending radius.

# SKIRTING 80

ANODIZED, POLISHED, VARNISHED and BRUSHED ALUMINIUM



BT... 80/80A

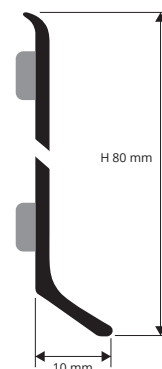

**ANODIZED SILVER ALUMINIUM thermo packed**  
bar length 2 lm - pack. 25 Pcs - 50 lm

Article	H mm
BTAA 80A	80
BTAA 80	80

**POLISHED TITANIUM ALUMINIUM thermo packed**  
bar length 2 lm - pack. 25 Pcs - 50 lm

Article	H mm
BTBT 80A	80
BTBT 80	80

**VARNISHED SEMIGLOSSY AND MATT WHITE ALUMINIUM thermo packed** - bar length 2 lm - pack. 25 Pcs - 50 lm

Article	H mm
BTA 80-01A	80
BTA 80-01	80
BTA 80-01OA	80
BTA 80-01O	80

**BRUSHED ALUMINIUM (silver-copper-titanium) thermo packed** - bar length 2 lm - pack. 25 Pcs - 50 lm

Article	H mm
BTBS 80A	80
BTBS 80	80
BTRS 80A	80
BTRS 80	80
BTTS 80A	80
BTTS 80	80

**STONE LINE ALUMINIUM thermo packed** - bar length 2 lm - pack. 40 Pcs - 80 lm

Article	H mm
⊕ BTA 80-SL01A	80
⊕ BTA 80-SL01	80
⊕ BTA 80-SL08A	80
⊕ BTA 80-SL08	80
⊕ BTA 80-SL12A	80
⊕ BTA 80-SL12	80

EXAMPLES AND INSTRUCTIONS FOR LAYING METHODS

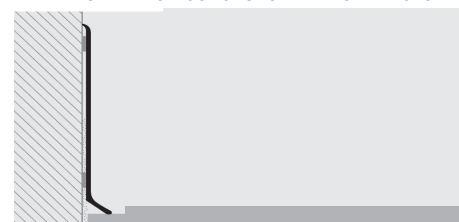

USE PROBAND FIX FOR FIXING THE PROFILE TO THE WALL

## COLOURS

ANODIZED	POLISHED	BRUSHED	SEMIGLOSSY	MATT	STONE LINE				
AA - Anodized silver alum.	BT - Polished titanium alum.	BS - Brushed silver alum.	TS - Brushed copper alum.	01 - White varnished alum. (9016)	010 - White varnished alum. (9016)	SL01 - Stone white	SL08 - Stone antrdark	SL12 - Stone black	On demand

# CORNERS, END CAPS AND JOINTS

VARNISHED METAL and VARNISHED PLASTIC

\* Corners, end caps and joints of the on demand profiles are also on demand

**INTERNAL/EXTERNAL CORNER - EDGE COVER - VARNISHED METAL**  
ANODIZED, POLISHED, STONE LINE - H 80 X L 20

Article
RIZCTAA 80/...
REZCTAA 80/...
RIZCTBT/BS/TS/RS 80/...
REZCTBT/BS/TS/RS 80/...
RIZCT01/01O 80/...
REZCT01/01O 80/...
⊕ RIZCTA 80-SL.../...
⊕ REZCTA 80-SL.../...

Choose the desired packaging.  
E.g.: RIZCTAA 80/2 (pack. 2 Pcs) - RIZCTAA 80/5 (pack. 5 Pcs)

**INTERNAL/EXTERNAL CORNER - EDGE COVER**  
VARNISHED PLASTIC ANODIZED SILVER, POLISHED AND TITANIUM

Article	HxL mm
RICTAA 80/...	80 x 20
RECTAA 80/...	80 x 20
RICTBT 80/...	80 x 20
RECBT 80/...	80 x 20

**JOINT - EDGE COVER**  
VARNISHED PLASTIC ANODIZED SILVER, POLISHED AND TITANIUM

Article	H mm
GICTAA 80/...	80
GICTBT 80/...	80

**END CAPS R / L - EDGE COVER - VARNISHED PLASTIC ANODIZED SILVER, POLISHED AND TITANIUM** - pack. 4Pcs (2R+2L) / 10Pcs (5R+5L)

Article	H mm
TPCTAA 80/...	80
TPCTBT 80/...	80

**JOINT - EDGE COVER**  
VARNISHED METAL ANODIZED, POLISHED, STONE LINE

Article	H mm
GIZCTAA 80/...	80
GIZCTBT/BS/TS/RS 80/...	80
GIZCT01/01O 80/...	80
⊕ GIZCTA 80-SL.../...	80

**END CAPS R / L - EDGE COVER - VARNISHED METAL ANODIZED, POLISHED, STONE LINE** - pack. 4Pcs (2R+2L) / 10Pcs (5R+5L)

Article	H mm
TPZCTAA 80/...	80
TPZCTBT/BS/TS/RS 80/...	80
TPZCT01/01O 80/...	80
⊕ TPZCTA 80-SL.../...	80

Choose the desired packaging.  
E.g.: TPCCTAA 80/2 (pack. 4 Pcs: 2 right + 2 left)

**INTERNAL/EXTERNAL CORNER - FLUSH**  
VARNISHED PLASTIC ANODIZED SILVER, POLISHED AND TITANIUM

Article	HxL mm
RIBAA 80/...	80 x 25
REBAA 80/...	80 x 25
RIBBT 80/...	80 x 25
REBBT 80/...	80 x 25

**JOINT - FLUSH**  
VARNISHED PLASTIC ANODIZED SILVER, POLISHED AND TITANIUM

Article	H mm
GIBAA 80/...	80
GIBBT 80/...	80

**END CAPS R / L - FLUSH - VARNISHED PLASTIC ANODIZED SILVER, POLISHED AND TITANIUM** - pack. 4Pcs (2R+2L) / 10Pcs (5R+5L)

Article	H mm
TPBAA 80/...	80
TPBBT 80/...	80

Available on demand aluminium prewelded internal and external flush corners. Finishing: 01 - 010 - AA - BT - BS - RS - TS. Price to be agreed. Production delay 4/5 weeks.

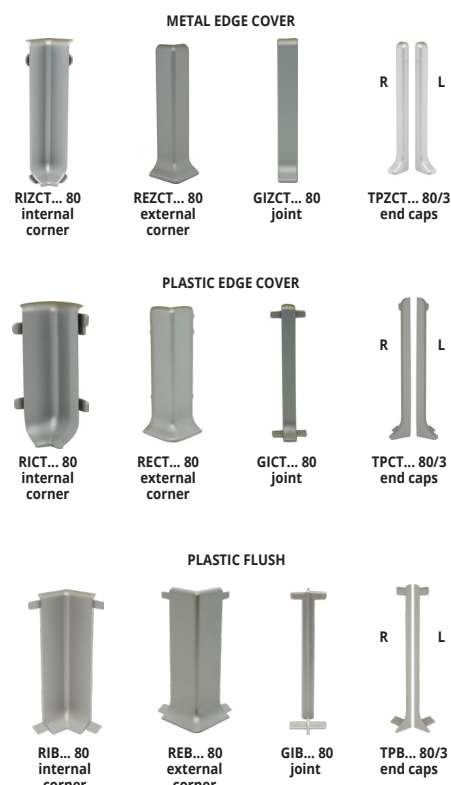

\*\* = Production on demand with minimum quantity of 80 Pcs. Production delay 4/5 weeks. Price to be agreed

\* = Production on demand with minimum quantity of 100 Pcs. Production delay 4/5 weeks. Price to be agreed

⊕ = News 2021

# SKIRTING 100 SKIRTING 150

POLISHED AND BRUSHED  
STAINLESS STEEL AISI 304/1.4301-V2A

**SKIRTING 100** and **SKIRTING 150** made in stainless steel AISI 304/1.4301-V2A in height 100 and 150 mm. Available with or without adhesive. Superior aesthetic quality, extremely strong and easy to lay, it is ideal for all public and private environments that require high standards of hygiene and image. Used increasingly more often in contrast combinations with wood, carpeted floors, etc. for an unmistakable hi-tech effect. In order to facilitate and to perfect the laying process, internal and external angles, plugs and junctions are recommended.

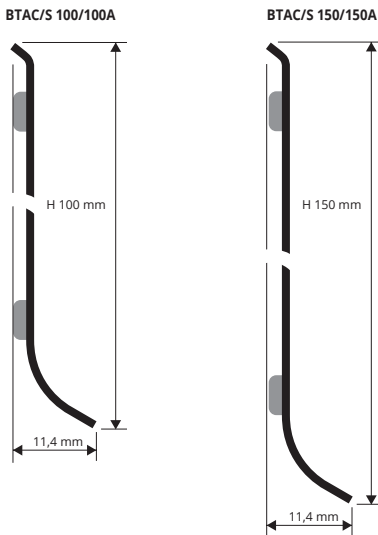

## EXAMPLES OF LAYING

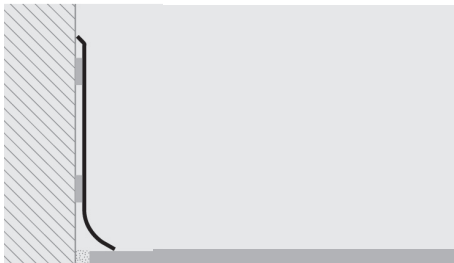

**POLISHED STAINLESS STEEL AISI 304/1.4301-V2**  
with protective film - bar length 2 lm - pack. 20 Pcs - 40 lm

Article	H mm		
BTAC 100A	100		
BTAC 100	100		

**Brushed STAINLESS STEEL AISI 304/1.4301-V2A**  
with protective film - bar length 2 lm - pack. 20 Pcs - 40 lm

Article	H mm		
BTACS 100A	100		
BTACS 100	100		

"A" at the end of the product code = Item with adhesive

**SUITABLE FOR USE IN CONTACT WITH FOODSTUFFS**

### LAYING INSTRUCTIONS

1. Choose the "SKIRTING 100 -150" also choose with or without adhesive. 2. Cut the profile to the required length, taking care to calculate the width of the inside-outside corner joints. 3. For the self-adhesive version, the surface must be smooth, grease-free and not porous. It is not recommended for plaster and mortar surfaces (version without adhesive is better, using fast-setting acrylic silicone which is suitable for fixing aluminium to mortar - plaster, etc.). 4. Use the corner linking elements-joints and right and left end caps to facilitate laying.



**POLISHED STAINLESS STEEL AISI 304/1.4301-V2**  
with protective film - bar length 2 lm - pack. 20 Pcs - 40 lm

Article	H mm		
BTAC 150A	150		
BTAC 150	150		

**Brushed STAINLESS STEEL AISI 304/1.4301-V2A**  
with protective film - bar length 2 lm - pack. 20 Pcs - 40 lm

Article	H mm		
BTACS 150A	150		
BTACS 150	150		

"A" at the end of the product code = Item with adhesive

**USE PROBAND FIX FOR FIXING THE PROFILE TO THE WALL**



## COLOURS

AC - Polished stainless steel AISI 304/1.4301-V2A	ACS - Brushed stainless steel AISI 304/1.4301-V2A

# CORNERS, END CAPS AND JOINTS

STEEL and VARNISHED METAL

## EDGE COVER VARNISHED METAL



RIZCT... 100  
internal corner



REZCT... 100  
external corner



GIZCT... 100  
joint

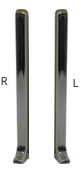

TPZCT... 100/3  
end caps

## STEEL PRE-WELDED



RI... 100 / 150  
internal corner



RE... 100 / 150  
external corner

## VARNISHED METAL - EDGE COVER CORNERS H100 - articles not for sale singly

### INTERNAL/EXTERNAL CORNER - EDGE COVER VARNISHED METAL POLISHED STEEL EFFECT

Article	HxL mm	pack. 2Pcs	pack. 5Pcs
RIZCTAC 100/...	100 x 20		
REZCTAC 100/...	100 x 20		

### JOINT - EDGE COVER

#### VARNISHED METAL POLISHED STEEL EFFECT

Article	H mm	pack. 2Pcs	pack. 5Pcs
GIZCTAC 100/...	100		

Choose the desired packaging.

E.g.: RIZCTAC 100/2 (pack. 2 Pcs) - RIZCTAC 100/5 (pack. 5 Pcs)

### END CAPS R / L - EDGE COVER - VARNISHED METAL POLISHED STEEL EFFECT - pack. 4Pcs (2 R + 2 L) / 10Pcs (5 R + 5 L)

Article	H mm	pack. 4Pcs	pack. 10Pcs
TPZCTAC 100/...	100		

Choose the desired packaging.

E.g.: TPCCTAC 100/2 (pack. 4 Pcs: 2 right + 2 left)  
TPCCTAC 100/5 (pack. 10 Pcs: 5 right + 5 left)

## STEEL AISI 304/1.4301-V2A - FLUSH CORNERS H100 articles not for sale singly

### INTERNAL/EXTERNAL CORNER - FLUSH PRE-WELDED POLISHED-BRUSHED STAINLESS STEEL EFFECT

Article	HxL mm	pack. 2Pcs	pack. 5Pcs
RIAC 100/...	100 x 50		
REAC 100/..	100 x 50		
RIACS 100/...	100 x 50		
REACS 100/...	100 x 50		

Choose the desired packaging.

E.g.: RIAC 100/2 (pack. 2 Pcs) - RIAC 100/5 (pack. 5 Pcs)

### INTERNAL/EXTERNAL CORNER - EDGE COVER VARNISHED METAL BRUSHED STAINLESS ST. EFFECT

Article	HxL mm	pack. 2Pcs	pack. 5Pcs
RIZCTACS 100/...	100 x 20		
REZCTACS 100/...	100 x 20		

### JOINT - EDGE COVER

#### VARNISHED METAL BRUSHED STAINLESS ST. EFFECT

Article	H mm	pack. 2Pcs	pack. 5Pcs
GIZCTACS 100/...	100		

Choose the desired packaging.

E.g.: RIZCTACS 100/2 (pack. 2 Pcs) - RIZCTACS 100/5 (pack. 5 Pcs)

### END CAPS R / L - EDGE COVER - VARNISHED METAL BRUSHED STAINLESS ST. EFFECT - pack. 4Pcs (2 R + 2 L) / 10Pcs (5 R + 5 L)

Article	H mm	pack. 4Pcs	pack. 10Pcs
TPZCTACS 100/...	100		

Choose the desired packaging.

E.g.: TPCCTACS 100/2 (pack. 4 Pcs: 2 right + 2 left)  
TPCCTACS 100/5 (pack. 10 Pcs: 5 right + 5 left)

## STEEL AISI 304/1.4301-V2A - FLUSH CORNERS H150 articles not for sale singly

### INTERNAL/EXTERNAL CORNER - FLUSH PRE-WELDED POLISHED-BRUSHED STAINLESS STEEL EFFECT

Article	HxL mm	pack. 2Pcs	pack. 5Pcs
RIAC 150/...	150 x 50		
REAC 150/...	150 x 50		
RIACS 150/...	150 x 50		
REACS 150/...	150 x 50		

Choose the desired packaging.

E.g.: RIACS 150/2 (pack. 2 Pcs) - RIACS 150/5 (pack. 5 Pcs)



**SKIRTING 100** made in anodized, polished and brushed aluminium in height 100 mm. Available with or without adhesive. Superior aesthetic quality and easy to lay, it is ideal for all public and private environments. Can be used with all types of flooring.  
In order to facilitate and to perfect the laying process, internal and external angles, plugs and junctions are recommended.  
Please contact the technical department for informations concerning the skirting bending radius.

# SKIRTING 100

ANODIZED, POLISHED, VARNISHED and BRUSHED ALUMINIUM

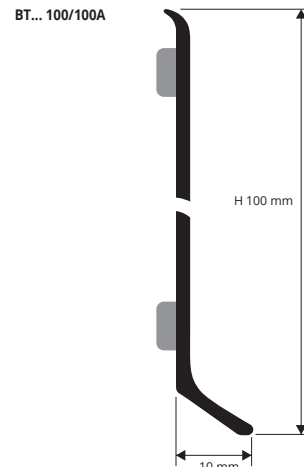

**ANODIZED SILVER ALUMINIUM thermo packed**  
bar length 2 lm - pack. 20 Pcs - 40 lm

Article	H mm
BTAA 100A	100
BTAA 100	100

**POLISHED TITANIUM ALUMINIUM thermo packed**  
bar length 2 lm - pack. 20 Pcs - 40 lm

Article	H mm
BTBT 100A	100
BTBT 100	100

**VARNISHED SEMIGLOSSY AND MATT WHITE ALUMINIUM thermo packed** - bar length 2 lm - pack. 20 Pcs - 40 lm

Article	H mm
BTA 100-01A	100
BTA 100-01	100
BTA 100-010A	100
BTA 100-010	100

**BRUSHED ALUMINIUM (silver-copper-titanium) thermo packed** - bar length 2 lm - pack. 20 Pcs - 40 lm

Article	H mm
BTBS 100A	100
BTBS 100	100
BTRS 100A	100
BTRS 100	100
BTTS 100A	100
BTTS 100	100

**STONE LINE ALUMINIUM thermo packed** - bar length 2 lm - pack. 40 Pcs - 80 lm

Article	H mm
⊕ BTA 100-SL01A	100
⊕ BTA 100-SL01	100
⊕ BTA 100-SL08A	100
⊕ BTA 100-SL08	100
⊕ BTA 100-SL12A	100
⊕ BTA 100-SL12	100

EXAMPLES AND INSTRUCTIONS FOR LAYING METHODS

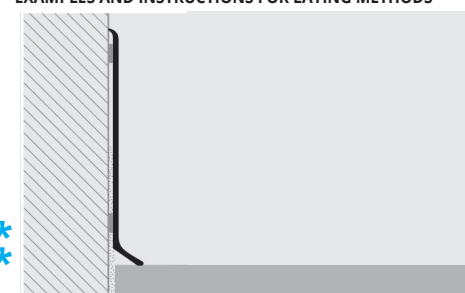

USE PROBAND FIX FOR FIXING THE PROFILE TO THE WALL

## COLOURS

ANODIZED	POLISHED	BRUSHED	SEMIGLOSSY	MATT	STONE LINE
AA - Anodized silver alum.	BT - Polished titanium alum.	BS - Brushed silver alum.	RS - Brushed copper alum.	TS - Brushed titanium alum.	O1 - White varnished alum. (9016)
				O10 - White varnished alum. (9016)	SL01 - Stone white
					SL08 - Stone antrdark
					SL12 - Stone black

## CORNERS, END CAPS AND JOINTS

VARNISHED METAL and VARNISHED PLASTIC

\* Corners, end caps and joints of the on demand profiles are also on demand

**INTERNAL/EXTERNAL CORNER - EDGE COVER - VARNISHED METAL, ANODIZED, POLISHED STONE LINE - H 100 MM - L 20 MM**

Article	pack. 2Pcs	pack. 5Pcs
RIZCTAA 100/...		
REZCTAA 100/...		
RIZCTBT/BS/TS/RS 100/...		
REZCTBT/BS/TS/RS 100/...		
RIZCT01/010 100/...		
REZCT01/010 100/...		
⊕ RIZCTA 100-SL.../...		
⊕ REZCTA 100-SL.../...		

Choose the desired packaging.

E.g.: RIZCTAA 100/2 (pack. 2 Pcs) - RIZCTAA 100/5 (pack. 5Pcs)

**JOINT - EDGE COVER VARNISHED METAL ANODIZED, POLISHED, STONE LINE**

Article	H mm
GIZCTAA 100/...	100
GIZCTBT/BS/TS/RS 100/...	100
GIZCT01/010 100/...	100
⊕ GIZCTA 100-SL.../...	100

**END CAPS R / L - EDGE COVER - VARNISHED METAL ANODIZED, POLISHED, STONE LINE - pack. 4Pcs (2 R + 2 L) / 10Pcs (5 R + 5 L)**

Article	H mm
TPZCTAA 100/...	100
TPZCTBT/BS/TS/RS 100/...	100
TPZCT01/010 100/...	100
⊕ TPZCTA 100-SL.../...	100



**INTERNAL/EXTERNAL CORNER - EDGE COVER VARNISHED PLASTIC ANODIZED SILVER, POLISHED AND TITANIUM**

Article	HxL mm	pack. 2Pcs	pack. 5Pcs
RICTAA 100/...	100 x 20		
RECTAA 100/...	100 x 20		
RICTBT 100/...	100 x 20		
RECTBT 100/...	100 x 20		

Choose the desired packaging.

E.g.: RICTAA 100/2 (pack. 2 Pcs) - RICTAA 100/5 (pack. 5 Pcs)

Available on demand aluminium prewelded internal and external flush corners. Finishing: 01 - 010 - AA - BT - BS - RS - TS. Price to be agreed. Production delay 4/5 weeks.

**JOINT - EDGE COVER VARNISHED PLASTIC ANODIZED SILVER, POLISHED AND TITANIUM**

Article	H mm
GICTAA 100/...	100
GICTBT 100/...	100

**END CAPS R / L - EDGE COVER - VARNISHED PLASTIC ANODIZED SILVER, POLISHED AND TITANIUM - pack. 4Pcs (2 R + 2 L) / 10Pcs (5 R + 5 L)**

Article	H mm
TPCTAA 100/...	100
TPCTBT 100/...	100

Choose the desired packaging.

E.g.: TPCTAA 100/2 (pack. 4 Pcs: 2 right + 2 left)

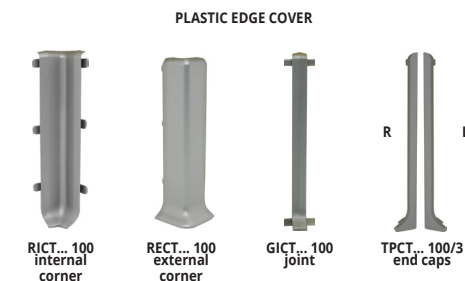

\*\* = Production on demand with minimum quantity of 80 Pcs. Production delay 4/5 weeks. Price to be agreed

\* = Production on demand with minimum quantity of 100 Pcs. Production delay 4/5 weeks. Price to be agreed

⊕ = News 2021

# PROMULTISKIRT SQUARE

FOAMED VINYL RESIN

**PROMULTISKIRT SQUARE** is an expanded vinyl resin profile covered with a vinyl resin film available in white, black, silver and wood finishes. The profile has a good resistance to chemical agents and can be secured to the wall with plastic supports fixed with screws or silicone. The skirting height is 100 mm, it can be cut to 80 and 60 mm heights thanks to the pre-incisions on the back. **PROMULTISKIRT SQUARE** in expanded vinyl resin coated with vinyl resin film is suitable for any indoor environment.

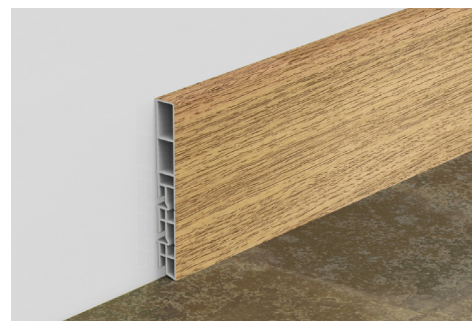
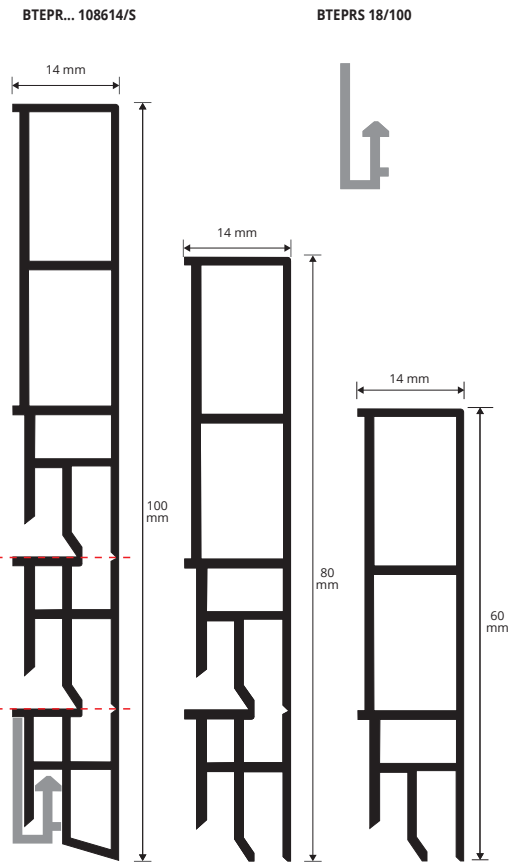

**FOAMED VINYL RESIN (wood finishes - black - white and silver)**  
bar length 2,4 lm - pack. 20 Pcs - 48 lm

Article	H mm
BTEPR... 108614/S	100/80/60

Available in the finishes: 29W - 30W - 34W - B - N - AA.  
The code of the selected colour must be added to the article code.  
E.g.: BTEPR...108614/S (chosen finish Havana oak) BTEPR34W 108614/S



**SUPPORT / FIXING CLIP - PLASTIC**  
pack. 100 Pcs

Article	H mm
BTEPRS 18	16,5

Order the SUPPORT and choose the SKIRTING in the desired finish.

USE PROBAND FIX FOR FIXING THE PROFILE TO THE WALL



## COLOURS

(For a precise assessment of colours request the wood finishes sample range)



On request it is possible to realize other finishes of the color range: minimum order 400 pcs. Production delay 4/5 weeks. Price to be agreed. For sample finishes, contact the sales office for minimum quantities, timing and costs.

## LAYING INSTRUCTIONS

1. Choose "PROMULTISKIRT SQUARE" according to the chosen colour. 2. Cut "PROMULTISKIRT SQUARE" to the required length. 3. if necessary cut "PROMULTISKIRT SQUARE" to the required height. \* 4. Carefully clean the substrate on which the profile will be placed from oil, grease and dirt residues in general.

### Laying with adhesive only:

5a. . With dry surface apply the Proband Fix. 6a. Press the profile against the wall with the correct pressure.

### Laying with adhesive and support:

5b. Fix the plastic supports to the wall every 50mm with screws. 6b. Apply Proband Fix only to the back upper part of the skirting board. 7b. Fix the profile to the supports and press it against the wall with correct pressure.

## EXAMPLE OF LAYING

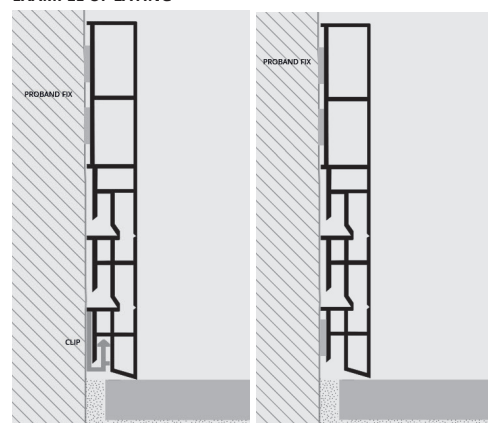

## \*CUT INSTRUCTIONS

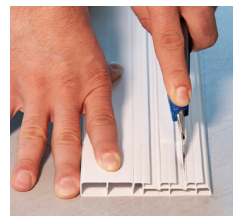

**Option 1A:** Cut to have the height 80 mm.  
Cut along the first pre-incision on the back of the skirting;

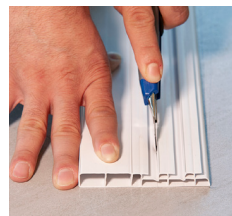

**Option 1B:** Cut to have the height 60 mm.  
Cut along the second pre-incision on the back of the skirting;

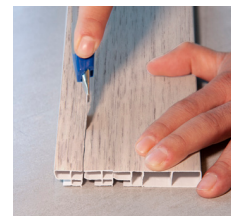

2. Cut the skirting on the front side at the cut previously made on the back;

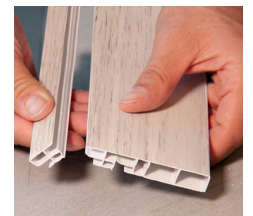

3. Remove the excess part.

# CORNERS, END CAPS AND JOINTS

FOAMED VINYL RESIN

## INTERNAL CORNER KIT

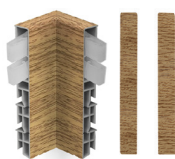

KIT BTEPR ... 108614/SI

## EXTERNAL CORNER KIT

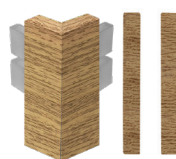

KIT BTEPR ...108614/SE

## IN/EXTERNAL CORNERS and END CAPS KIT

(wood finishes - black - white and silver)

Article	H mm
KBTEPR...108614/SI	100/80/60
KBTEPR...108614/SE	100/80/60

Available in the finishes: 29W - 30W - 34W - B - N - AA.  
The code of the selected colour must be added to the article code.  
E.g.: KBTEPR...108614/S (chosen finish Havana oak ) KBTEPR34W 108614/S



**PROMULTISKIRT ROUND** is an expanded vinyl resin profile covered with a vinyl resin film available in white, black, silver and wood finishes. The profile has a good resistance to chemical agents and can be secured to the wall with plastic supports fixed with screws or silicone. The skirting height is 100 mm, it can be cut to 80 and 60 mm heights thanks to the pre-incisions on the back. PROMULTISKIRT ROUND in expanded vinyl resin coated with vinyl resin film is suitable for any indoor environment.

# PROMULTISKIRT ROUND

FOAMED VINYL RESIN

**PATENTED**



**FOAMED VINYL RESIN (wood finishes - black - white and silver)**  
bar length **2,4 lm** - pack. **20 Pcs - 48 lm**

**SUPPORT / FIXING CLIP - PLASTIC**  
pack. **100 Pcs**

Article	H mm
BTEPR... 108614/R	100/80/60

Article	H mm
BTEPRS 18	16,5

Available in the finishes: 29W - 30W - 34W - B - N - AA.  
The code of the selected colour must be added to the article code.  
E.g.: BTEPR...108614/R (chosen finish Havana oak) BTEPR34W 108614/R

Order the SUPPORT and choose the SKIRTING in the desired finish.

USE PROBAND FIX FOR FIXING THE PROFILE TO THE WALL



### COLOURS

(For a precise assessment of colours request the wood finishes sample range)



On request it is possible to realize other finishes of the color range: minimum order 400 pcs. Production delay 4/5 weeks. Price to be agreed. For sample finishes, contact the sales office for minimum quantities, timing and costs.

**LAYING INSTRUCTIONS:** "PROMULTISKIRT ROUND" according to the chosen colour. **2.** Cut "PROMULTISKIRT ROUND" to the required length. **3.** if necessary cut "PROMULTISKIRT ROUND" to the required height. **4.** Carefully clean the substrate on which the profile will be placed from oil, grease and dirt residues in general.

#### Laying with adhesive only:

**5a.** With dry surface apply the Proband Fix. **6a.** Press the profile against the wall with the correct pressure.

#### Laying with adhesive and support:

**5b.** Fix the plastic supports to the wall every 50mm with screws. **6b.** Apply Proband Fix only to the back upper part of the skirting board.

**7b.** Fix the profile to the supports and press it against the wall with correct pressure.



**Option 1A:** Cut to have the height 80 mm.  
Cut along the first pre-incision on the back of the skirting;

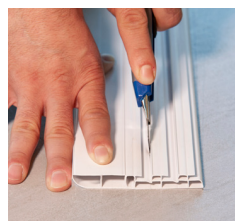

**Option 1B:** Cut to have the height 60 mm.  
Cut along the second pre-incision on the back of the skirting;

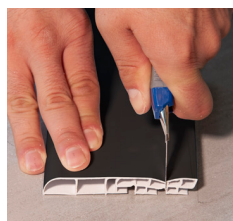

**2.** Cut the skirting on the front side at the cut previously made on the back;

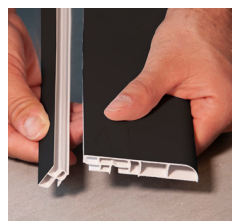

**3.** Remove the excess part.

BTEPR... 108614/R

BTEPRS 18/100

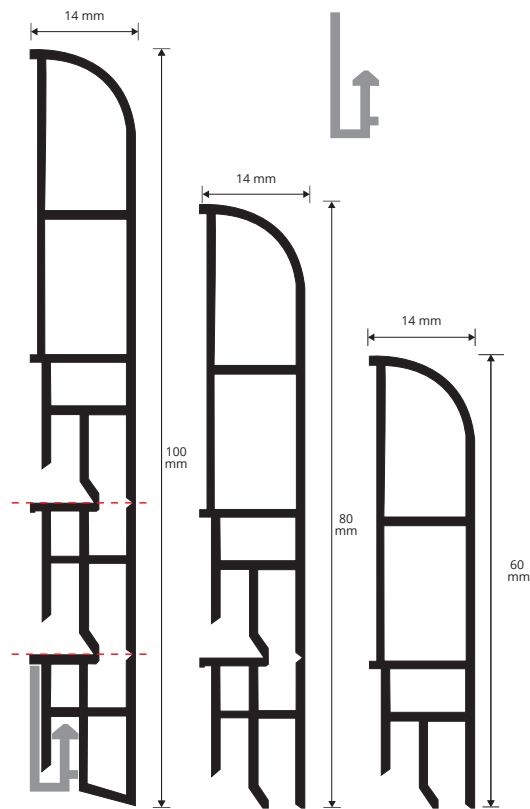

### EXAPLE OF LAYING

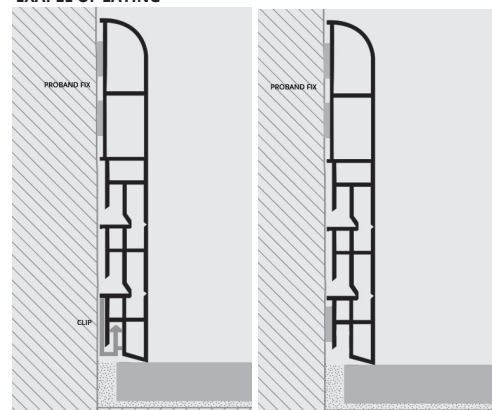

## CORNERS, END CAPS AND JOINTS

FOAMED VINYL RESIN

**IN/EXTERNAL CORNERS and END CAPS KIT**  
(wood finishes - black - white and silver)

Article	H mm
KBTEPR...108614/RI	100/80/60
KBTEPR...108614/RE	100/80/60

Available in the finishes: 29W - 30W - 34W - B - N - AA.  
The code of the selected colour must be added to the article code.  
E.g.: KBTEPR...108614/S (chosen finish Havana oak ) KBTEPR34W 108614/S

INTERNAL CORNER KIT

EXTERNAL CORNER KIT

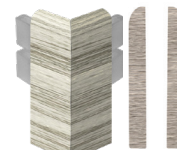
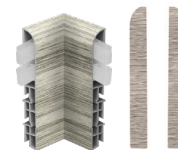

KIT BTEPR ...108614/RI

KIT BTEPR ...108614/RE

# SKIRTING 7016

FOAMED VINYL RESIN

**SKIRTING 7016** is a vinyl resin foam profile with a height of 70 mm. available wooden finishes and finishes in solid colour that could be matched with the PROINSERT SYSTEM's profiles. The profile, suitable like skirting for floating and glued wood floor, laminate and LVT, could be laid with suitable adhesive, nails, screws or using the pre-punched support fixed to the wall with screws every 57 cm. Its special section, that allows to cover a 16 mm sperimetral joint, and wide range of finishes make it a very requested, elegant and economic skirting profile.

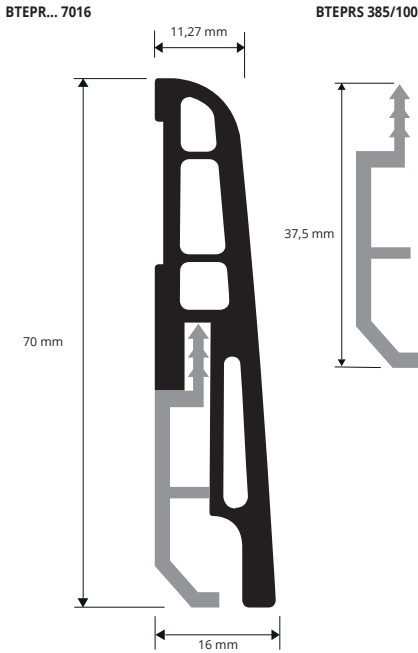

**FOAMED VINYL RESIN (wood finishes - black - white and silver)**  
Length = 2,5 m - Pack 20 pcs - 50 lm

Article	H mm
BTEPR... 7016	70



**SUPPORT / FIXING CLIP - PLASTIC**  
support Length 5 cm

Article	H mm
BTEPRS 385	37,5

USE PROBAND FIX FOR FIXING THE PROFILE TO THE WALL



**IN/EXTERNAL CORNERS and END CAPS KIT**  
(wood finishes - black - white and silver)

Article	H mm
KIT BTEPR ...7016I	70
KIT BTEPR ...7016E	70

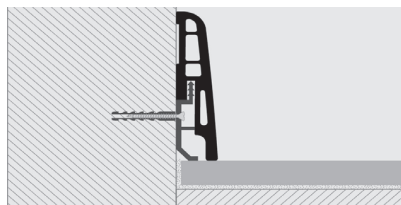

### EXAMPLES AND INSTRUCTIONS FOR LAYING METHODS

1. Choose "Skirting 7016" in the desired finish.
2. Fix the pre-punched support to the wall with screws every 50 cm.
3. Attach the profile to the support applying low pressure.
4. Alternatively fix the profile using a suitable fast adhesive, nails or screws

### COLOURS

(For a precise assessment of colours request the wood finishes sample range)

04W - Dark oak	05W - Light oak	13W - Teak indonesia	18W - Light Zerbano	21W - Powder Oak	25W - Bleached fir	29W - White oak	30W - Gray oak	31W - Victoria oak	33W - Sawed oak
34W - Havana oak	35W - Edimburgo oak	36W - American oak	37W - Carvi oak	38W - Queens oak	39W - Grey elm	41W - Ice oak	42W - Grace oak	45W - Morocco oak	46W - Black decap
53W	54W	55W	B - White	N - Black	AA - Silver				

On request it is possible to realize other finishes of the color range: minimum order 400 pcs. Production delay 4/5 weeks. Price to be agreed. For sample finishes, contact the sales office for minimum quantities, timing and costs.

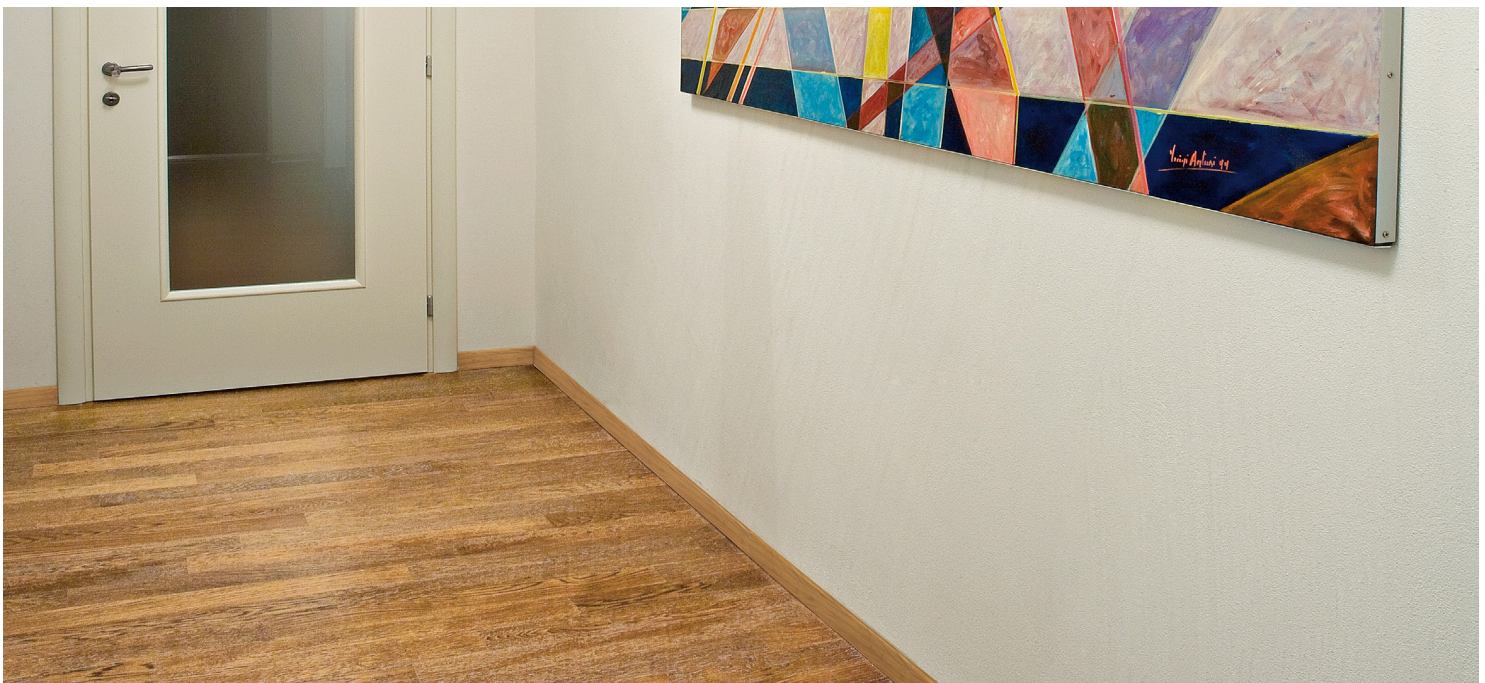



**SKIRTING 7011** is a vinyl resin foam profile with a height of 70 mm x 10,5 mm, available in wooden finishes and finishes standard colours that could be matched with the PROINSERT SYSTEM's profiles. Suitable as Basebord for floating and glued wood floor, laminate and LVT, could be laid with suitable adhesive, or else with nails .

# SKIRTING 7011

FOAMED VINYL RESIN



FOAMED VINYL RESIN (wood finishes - black - white and silver)  
Length = 2,5 m - Pack 20 pcs - 50 lm

Article	H mm
BTEPR... 7011	70



IN/EXTERNAL CORNERS and END CAPS KIT  
(wood finishes - black - white and silver)

Article	H mm
KIT BTEPR ...7011I	70
KIT BTEPR ...7011E	70

INTERNAL CORNER KIT



KIT BTEPR...7011I

EXTERNAL CORNER KIT



KIT BTEPR...7011E

USE PROBAND FIX FOR FIXING THE PROFILE TO THE WALL



## COLOURS

(For a precise assessment of colours request the wood finishes sample range)

05W - Light oak	07W - Light cherry	09W - Red walnut	18W - Light Zebano	21W - Powder Oak	29W - White oak	30W - Gray oak	31W - Victoria oak	32W - Pink oak	34W - Havana oak
35W - Edimburgo oak	37W - Carvi oak	40W - Brown oak	41W - Ice oak	42W - Grace oak	43W - Manhattan oak	44W - Honey oak	46W - Black decape	47W - Black oak	48W - Cork oak
49W - Sand oak	65W - Tripoli	73W - Bangkok	75W - Liotard	B - White	N - Black	AA - Silver			

On request it is possible to realize other finishes of the color range: minimum order 400 pcs. Production delay 4/5 weeks. Price to be agreed. For sample finishes, contact the sales office for minimum quantities, timing and costs.

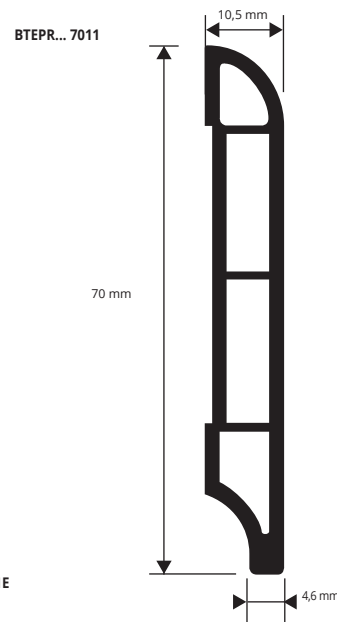

## EXAMPLES AND INSTRUCTIONS FOR LAYING METHODS

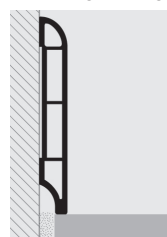

1. Choose the "Skirting 7011" in the required the colour.
2. Lay the "Skirting 7011" using quick-setting suitable adhesive for gluing flexible PVC onto mortar-plaster-accessorised walls, etc. or fix with nails.

**SKIRTING 40** is a vinyl resin foam profile with a height of 40 mm x 10 mm, available in wooden finishes and finishes standard colours that could be matched with the PROINSERT SYSTEM's profiles. Suitable as Basebord for floating and glued wood floor, laminate and LVT, could be laid with suitable adhesive, or else with nails .

# SKIRTING 40

FOAMED VINYL RESIN



FOAMED VINYL RESIN (wood finishes - black - white and silver)  
Length = 2,4 m - Pack. 20 PC - 48 ml

Article	H mm
BTEPR... 4010	40

Available in the finishes: 29W - 30W - 34W - B - N - AA.  
The code of the selected colour must be added to the article code.  
E.g.: BTEPR... 4010 (chosen finish Havana oak ) BTEPR34W 4010

USE PROBAND FIX FOR FIXING THE PROFILE TO THE WALL



## COLOURS

(For a precise assessment of colours request the wood finishes sample range)

29W - White oak	30W - Grey oak	34W - Havana oak	B - White	N - Black	AA - Silver
-----------------	----------------	------------------	-----------	-----------	-------------

On request it is possible to realize other finishes of the color range: minimum order 400 pcs. Production delay 4/5 weeks. Price to be agreed. For sample finishes, contact the sales office for minimum quantities, timing and costs.

IN/EXTERNAL CORNERS and END CAPS KIT  
(wood finishes - black - white and silver)

Article	H mm
KIT BTEPR ...4010I	40
KIT BTEPR ...4010E	40

INTERNAL CORNER KIT



KIT BTEPR...4010I

EXTERNAL CORNER KIT

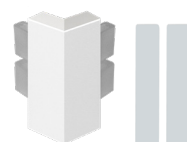

KIT BTEPR...4010E

BTEPR... 4010

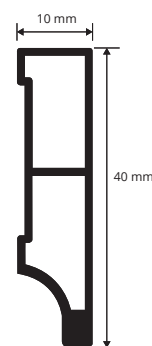

## EXAMPLES AND INSTRUCTIONS FOR LAYING METHODS

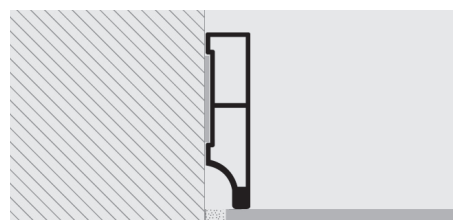

1. Choose the "Skirting 40" in the required the colour.
2. Lay the "Skirting 40" using quick-setting suitable adhesive for gluing flexible PVC onto mortar-plaster-accessorised walls, etc. or fix with nails.

# SKIRTING 60 SKIRTING 120

NON-TOXIC FLEXIBLE VINYL RESIN  
IN 6 COLOURS

PVC FLEXIBLE SKIRTING 60/120 height 60 mm and 120 mm, is a very strong profile ideal for easily achieving special, attractive, superior finishes. Installation recommended with glue or silicone. Easy to install, the shaped edges ensure perfect adhesion to the surface. The projecting rounded flange covers the terminal expansion joint.

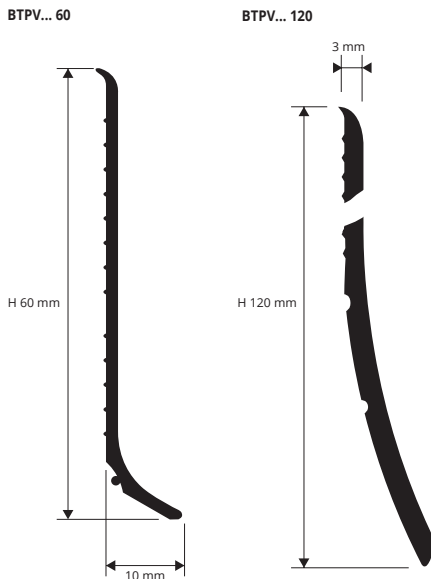

**ATTENTION: IN ORDER TO USE, LAY AND FIX PROPERLY THIS PRODUCT PLEASE LOOK AT OUR WEBSITE OR APP LAYING / FIXING VIDEO FOR CORRECT INSTALLATION.**



NON-TOXIC FLEXIBLE VINYL RESIN  
rolls length 50 lm

Article	H mm
BTPV... 60	60
BTPV... 120	120

Available in the colours: B - GC - GS - T - M - N.  
The code of the selected colour must be added to the article code.  
E.g.: BTPV... 60 (chosen finish light gray) BTPVGC 60.

NON-TOXIC FLEXIBLE VINYL RESIN - ADHESIVE  
rolls length 50 lm

Article	H mm
BTPV... 60A	60
BTPV... 120A	120

Available in the colours: B - GC - GS - T - M - N.  
The code of the selected colour must be added to the article code.  
E.g.: BTPV... 60 (chosen finish light gray) BTPVGC 60.

## COLOURS

B - White	GC - Light gray	GS - Dark gray	T - Dark brown	M - Brown	N - Black

## EXAMPLES AND INSTRUCTIONS FOR LAYING METHODS

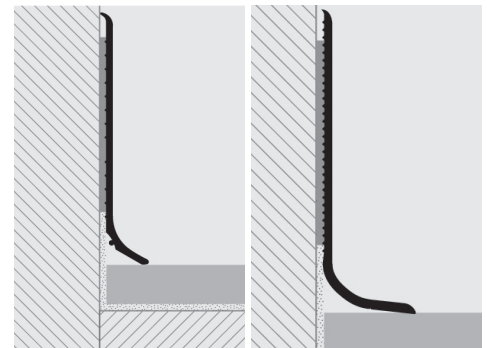

1. Choose the "SKIRTING 60 - 120" of the required height 60/120mm and choose the colour. 2. Lay the "SKIRTING 60 - 120" using an adhesive suitable for gluing flexible PVC onto mortar, plaster, accessorised walls, etc. or fix with screws/nails.

**As regards the items with adhesive, the adhesive roll is sold separately (50 lm for H:60), (50 lm for H:120)**

# SKIRTING 62F

FLEXIBLE VINYL RESIN  
IN 6 COLOURS

SKIRTING 62F is a new 62 mm skirting board made of non-toxic, flexible vinyl resin. This profile is very resistant and particularly suited for providing highly aesthetic perimeter skirting of excellent quality at reasonable prices. It differs from the BTPV... 60 skirting board in that it is provided with a bottom flange that allows it to be placed perpendicularly (90°) to the wall/lining and welded to PVC floors. In addition, the horizontal flange covers the floor's perimeter expansion joint. We recommend applying the skirting using glue/adhesive/Bostik/mastic. Alternatively, you can choose the self-adhesive version for quick, effortless installation.

BTPF... 62 / BTPF... 62A

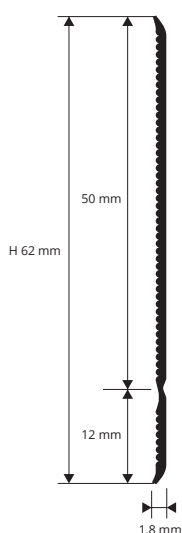

## EXAMPLES OF LAYING

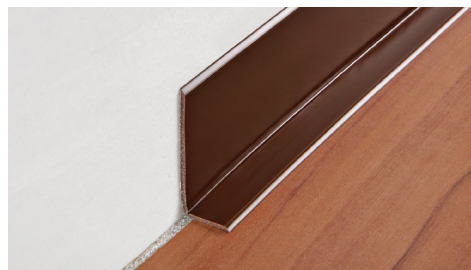
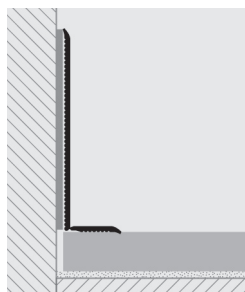

## LAYING INSTRUCTIONS

1. Choose the colour of the "SKIRTING 62F" board, indicating whether you want it with or without a self-adhesive backing. 2. Cut the "SKIRTING 62F" to length, taking into account the width of the internal and external connections. 3. Self-adhesive skirting is recommended only for surfaces that are perfectly smooth, non-oily and non-porous. On plaster and mortar surfaces, use a non-adhesive version and apply the skirting using quick-setting acrylic silicone suitable for gluing aluminium to mortar, plaster, etc.

**ATTENTION: IN ORDER TO USE, LAY AND FIX PROPERLY THIS PRODUCT PLEASE LOOK AT OUR WEBSITE OR APP LAYING / FIXING VIDEO FOR CORRECT INSTALLATION**



## FLEXIBLE VINYL RESIN

rolls length 50 lm with or without adhesive

Article	H mm
BTPF... 62	62

Available in the colours: B - GC - GS - T - M - N.  
The code of the selected colour must be added to the article code.  
E.g.: BTPF...62 (chosen finish light gray) BTPF62GC 62.

## FLEXIBLE VINYL RESIN

rolls length 50 lm with or without adhesive

Article	H mm
BTPF... 62A	62

Available in the colours: B - GC - GS - T - M - N.  
The code of the selected colour must be added to the article code.  
E.g.: BTPF...62 (chosen finish light gray) BTPF62GC 62.

**As regards the items with adhesive, the adhesive roll is sold separately (50 lm)**

## COLOURS

B - White	GC - Light gray	GS - Dark gray
T - Dark brown	M - Brown	N - Black





**SKIRTING** in PVC foam height 70 mm in 4 semi-matt colours and 8 wood finishes to be matched with the PROINSERT SYSTEM profiles for floating laminated wood floors and traditional parquet floors. Laying is done by gluing (acetic silicone - acrylic-mastic) or using screws or nails. Attractive, strong, hardwearing and economic, it is easy to lay and ideal for many public premises (hospitals, schools, gymnasiums, rest homes and creative areas) and private environments.

# SKIRTING

EXPANDED VINYL RESIN



**EXPANDED RIGID VINYL RESIN (black - light and dark grey - white)**  
bar length 2 lm - pack. 60 Pcs - 120 lm

Article	H mm
BTPR... 70	70

**EXPANDED RIGID VINYL RESIN (8 wood finishes)**  
bar length 2 lm - pack. 60 Pcs - 120 lm

Article	H mm
BTPR... 70	70

Available in the wood finishes: B - GC - GS - N - 04W - 05W - 06W - 07W - 08W - 09W - 10W - M.  
The code of the selected colour must be added to the article code. E.g.: BTPR... 70 (chosen colour black) BTPRN 70.

USE PROBAND FIX FOR FIXING THE PROFILE TO THE WALL



## COLOURS

B - White	GC - Light grey	GS - Dark grey	N - Black	04W - Dark beech	05W - Light oak (strip)
06W - Dark oak (walnut)	07W - Light cherry (strip)	08W - Dark cherry (board)	09W - Red walnut (merbau-apple-walnut)	10W - Wengé (panga panga-wengé)	M - Mogano

The shade of the wooden finish in rigid expanded vinyl resin/PVC results slightly different from the film usually applied on the profiles in aluminium.

BTPR...70

H 70 mm

10 mm

Skirting

## EXAMPLES AND INSTRUCTIONS FOR LAYING METHODS

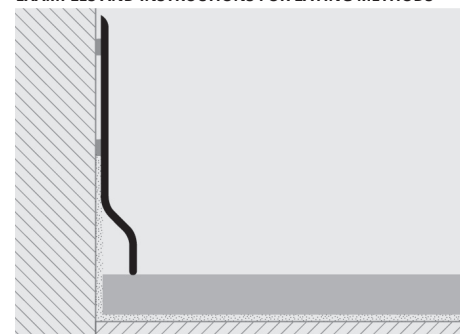

1. Choose the "SKIRTING" in the required the colour. 2. Lay the "SKIRTING" using quick-setting acrylic silicone, mastic or bostik, suitable for gluing flexible PVC onto mortar-plaster-accessorised walls, etc. or fix with screws/nails.

**ANGLE BAR** produced in expanded PVC in 4 semi-matt colours and 8 wood finishes used to protect angles. Laying is done by gluing (acetic silicone - acrylic-mastic) or using screws or nails. Attractive, strong, hardwearing and economic, it is easy to lay and ideal for many public premises (hospitals, schools, gymnasiums, rest homes and creative areas) and private environments.

# ANGLE BAR

EXPANDED VINYL RESIN

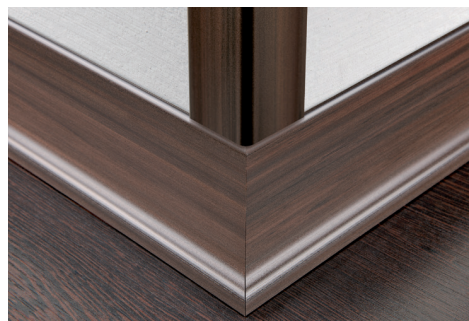

**EXPANDED RIGID VINYL RESIN (black - light and dark grey - white)**  
bar length 2,7 lm - pack. 40 Pcs - 108 lm

Article	L x H mm
AGE... 25	25 x 25

**EXPANDED RIGID VINYL RESIN (8 wood finishes)**  
bar length 2,7 lm - pack. 40 Pcs - 108 lm

Article	L x H mm
AGE... 25	25 x 25

Available in the wood finishes: B - GC - GS - 11 - 04W - 05W - 06W - 07W - 08W - 09W - 10W - M.  
The code of the selected colour must be added to the article code. E.g.: AGE... 25 (chosen finish black) AGE11 25.

USE PROBAND FIX FOR FIXING THE PROFILE TO THE WALL



AGE...25

25 mm

H 25 mm

edge guard

## EXAMPLES OF LAYING

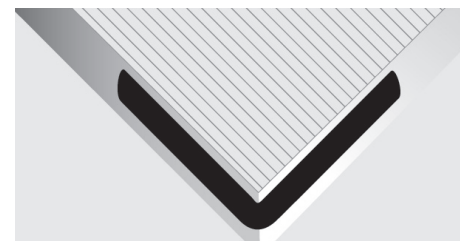

The shade of the wooden finish in rigid expanded vinyl resin/PVC results slightly different from the film usually applied on the profiles in aluminium.

# PROSEAL WOOD

EXPANDED PVC  
2 WOOD FINISHING AND 4 MATCHING COLOURS

**PROSEAL WOOD** is a new inner connector square suitable for creating a concave skirting for wood / rolled-melamine floating wood / ceramic / marble tiles to reduce the floor /covering detachment. The particular material used allows to resist to the main chemical agents ant to small breakages. **PROSEAL WOOD's** dimensions allow the necessary expansion of the outer joint. Ideal for public (schools, rest homes, recreational area) and private places. In expanded PVC , in 2 wood finishes 4 in matching colours to combine with various wood finishes. Easy to lay with fixing silicone.

transition profiles

PSAW... 20

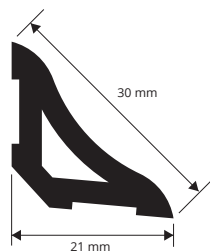

### EXAMPLES AND INSTRUCTIONS FOR LAYING METHODS

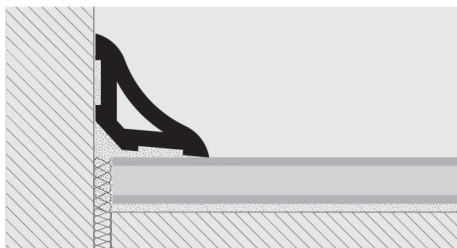

1. Choose "PROSEAL WOOD" color and/or wood finish required.
2. The laying must be carried out using fast fixing acrylic silicone, mastic, bostik suitable for gluing PVC with mortar - plaster - wall units etc., or fix using screws/nails.



**EXPANDED PVC - 2 WOOD FINISHING**  
bar length 2,5 lm - pack. 40 Pcs - 100 lm

Article	L x H mm
PSAW... 20	21 x 21

Available in the wood finishes: 05W - 10W , and colours: B - GC - GS - N.  
The code of the selected colour must be added to the article code. E.g.: PSAW...20 (chosen finish black) PSAWN 20.



**EXPANDED PVC - 4 COLOURS**  
bar length 2,5 lm - pack. 40 Pcs - 100 lm

Article	L x H mm
PSAW... 20	21 x 21



USE PROBAND FIX FOR FIXING THE PROFILE TO THE WALL

### COLOURS

B - White	GC - Light gray	GS - Dark gray	N - Black	05W - Light oak (strip)	10W - Wengé (panga panga-wengé)

The shade of the wooden finish in rigid expanded vinyl resin/PVC results slightly different from the film usually applied on the profiles in aluminium.

# PROANGLE WOOD

EXPANDED PVC  
2 WOOD FINISHING AND 4 MATCHING COLOURS

**PROANGLE WOOD** is a new inner connector square suitable for creating a convex skirting for wood / rolled-melamine floating wood / ceramic / marble floor to reduce the floor /covering detachment. The particular material used allows to resist to the main chemical agents and to small breakages. **PROANGLE WOOD's** dimensions allow the necessary expansion of the outer joint. Ideal for public (schools, rest homes, recreational area) and private places. In expanded PVC , in 2 wood finishes 4 in matching colors to combine with various wood finishes. Easy to lay with fixing silicone.

transition profiles

PGAW... 15

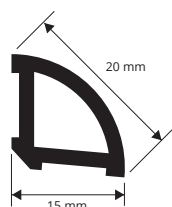

### EXAMPLES AND INSTRUCTIONS FOR LAYING METHODS

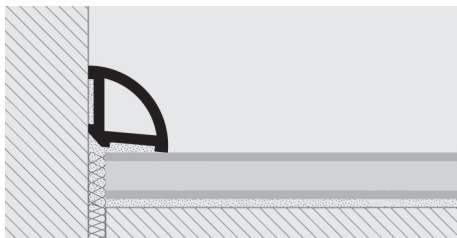

1. Choose "PROANGLE WOOD" color and/or wood finish required.
2. The laying must be carried out using fast fixing acrylic silicone, mastic, bostik, suitable for glueing PVC with mortar-plaster-wall units etc., or fix using screws/nails.



**EXPANDED PVC - 2 WOOD FINISHING**  
bar length 2,5 lm - pack. 40 Pcs - 100 lm

Article	L x H mm
PGAW... 15	15 x 15

Available in the wood finishes: 05W - 10W, and colours: - GC - GS - N.  
The code of the selected colour must be added to the article code. E.g.: PGAW...15 (chosen finish black) PGAWN 15.



**EXPANDED PVC - 4 COLOURS**  
bar length 2,5 lm - pack. 40 Pcs - 100 lm

Article	L x H mm
PGAW... 15	15 x 15

USE PROBAND FIX FOR FIXING THE PROFILE TO THE WALL



### COLOURS

B - White	GC - Light gray	GS - Dark gray	N - Black	05W - Light oak (strip)	10W - Wengé (panga panga-wengé)

The shade of the wooden finish in rigid expanded vinyl resin/PVC results slightly different from the film usually applied on the profiles in aluminium.

**SKIRTING COVECAP** is a series of flexible co-extruded non-toxic vinyl profiles. **SKIRTING COVECAP** is a **SKIRTING/ SKIRTING** with capping seal used to provide an elegant and functional solution to finish the top of resilient floor covering where it has been covered up to the wall, support floor covering at a weal point and protects the exposed edges. The visible portion of the profiles is rounded and available in white - light grey - dark grey - dark brown - brown and black.

# SKIRTING COVECAP

NON-TOXIC FLEXIBLE CO-EXTRUDED VINYL RESIN



NON-TOXIC FLEXIBLE CO-EXTRUDED VINYL RESIN - bar length 2,50 lm  
Pack H 60 mm / 40 Pcs - H 80 mm / 30 Pcs - H 100 mm / 20 Pcs

Article	H mm
BTVCC... 60	60
BTVCC... 80	80
BTVCC... 100	100

Available in the colours: B - GC - GS - T - M - N.  
The code of the selected colour must be added to the article code.  
E.g.: BTVCC... 60 (chosen colour white) BTVCCB 60.

**Adhesive version: add the letter A after the article. As regards the items with adhesive, the adhesive roll is sold separately.**

## COLOURS - FLEXIBLE PART

B - White	GC - Light gray	GS - Dark gray	T - Dark brown	M - Brown	N - Black

## EXAMPLES AND INSTRUCTIONS FOR LAYING METHODS

1. Select the "SKIRTING COVECAP" of the desired color and height.  
2. Using a utility knife cut the "SKIRTING COVECAP" to the desired length.  
3. Apply the proper adhesive or glue/mastic and install the profile

**ATTENTION: THE INSTALLATION OF THIS PROFILES IS RECOMMENDED FOR AN EXPERT INSTALLER OF VINYL FLOORINGS**

BTVCC... 80

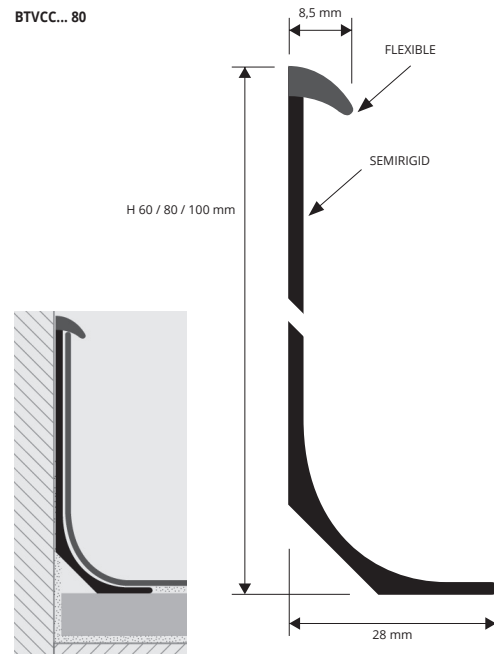

SEMIRIGID



**PROCAP** is a non-toxic co-extruded flexible vinyl resin profile that in combination with PROSEAL FLEX allows a correct application and finishing of vinyl flooring and carpet along the wall-floor joint. The visible surface of the profile is available in white, light gray, dark gray, dark brown, brown and black. Its ease of application makes it a very practical profile for the finishing of vinyl and carpet flooring

# PROCAP S

NON-TOXIC CO-EXTRUDED FLEXIBLE VINYL RESIN

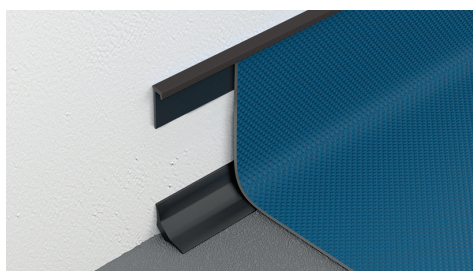

PROCAP S - NON-TOXIC FLEXIBLE CO-EXTRUDED VINYL RESIN  
bar length 2,50 - pack. 20 Pcs - 50 lm

Article	H x L mm
PRCPS...	31 x 5,3

Available in the colours: B - GC - GS - T - M - N.  
The code of the selected colour must be added to the article code.  
E.g.: PRCPL... (chosen colour white) PRCPLB

PROSEAL FLEX - FLEXIBLE BLACK NON-TOXIC VINYL RESIN  
bar length 2,5 lm - pack. 40 Pcs - 100 lm

Article	L X H mm
PSF 15-11	15x15
PSF 20-11	20x20
PSF 25-11	25x25

## COLOURS

PLAIN PRCPS & EMBOSSED PRCPL		
B - White	GC - Light gray	GS - Dark gray
T - Dark brown	M - Brown	N - Black

## EXAMPLES AND INSTRUCTIONS FOR LAYING METHODS

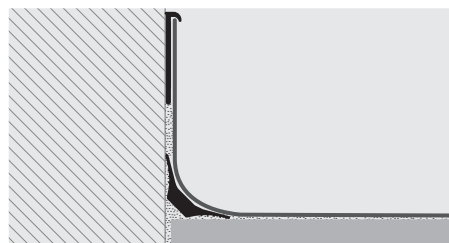

PRCPS

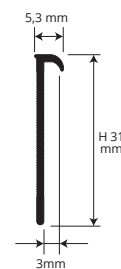

PSF

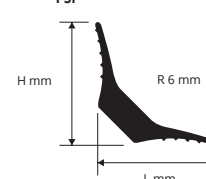

1. Choose "PROCAP S" according to height and desired colour.  
2. Cut "PROCAP S" to the right length.  
3. Apply a suitable adhesive and lay the profile.  
4. Lay the desired resilient flooring.

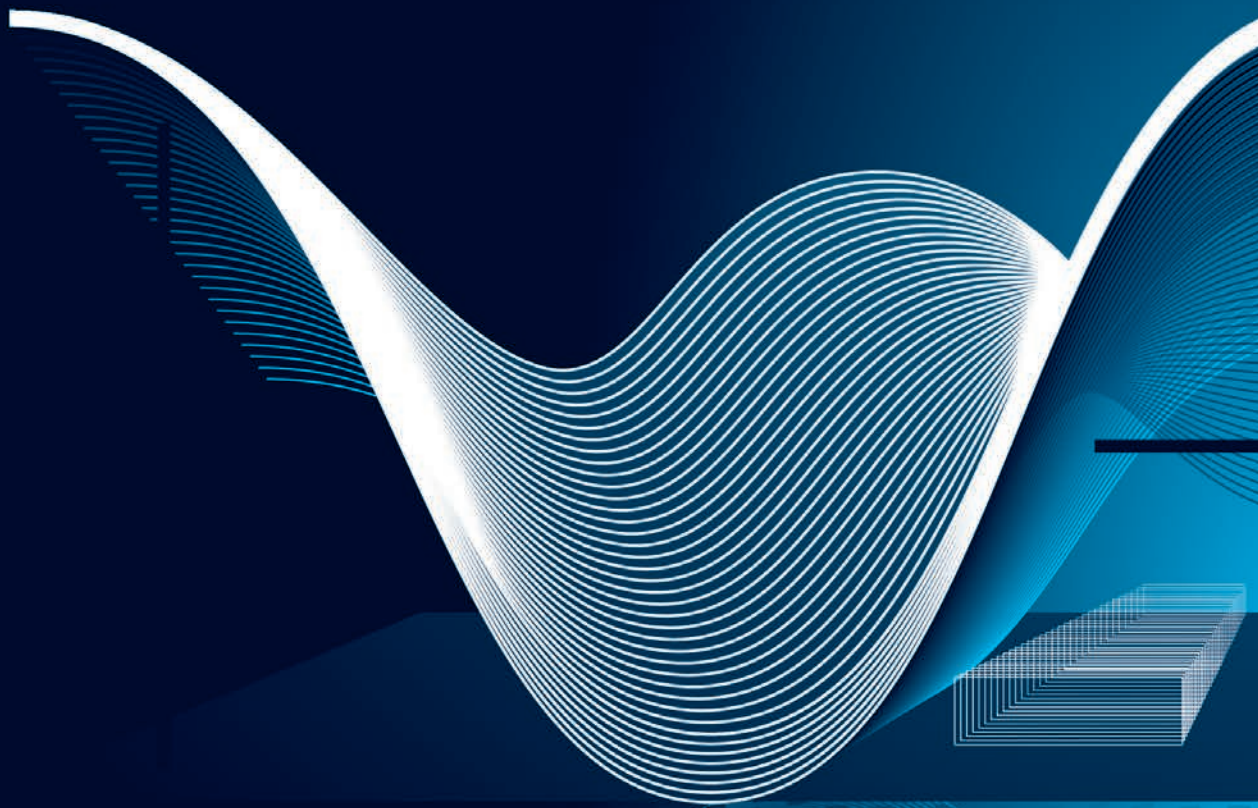

An interpretation of:  
**Bosjes Chapel, Steyn Studio, CAPE TOWN (South Africa), 2016**

PROFILES FOR LAMINATE, PARQUET  
AND CARPETED FLOORS

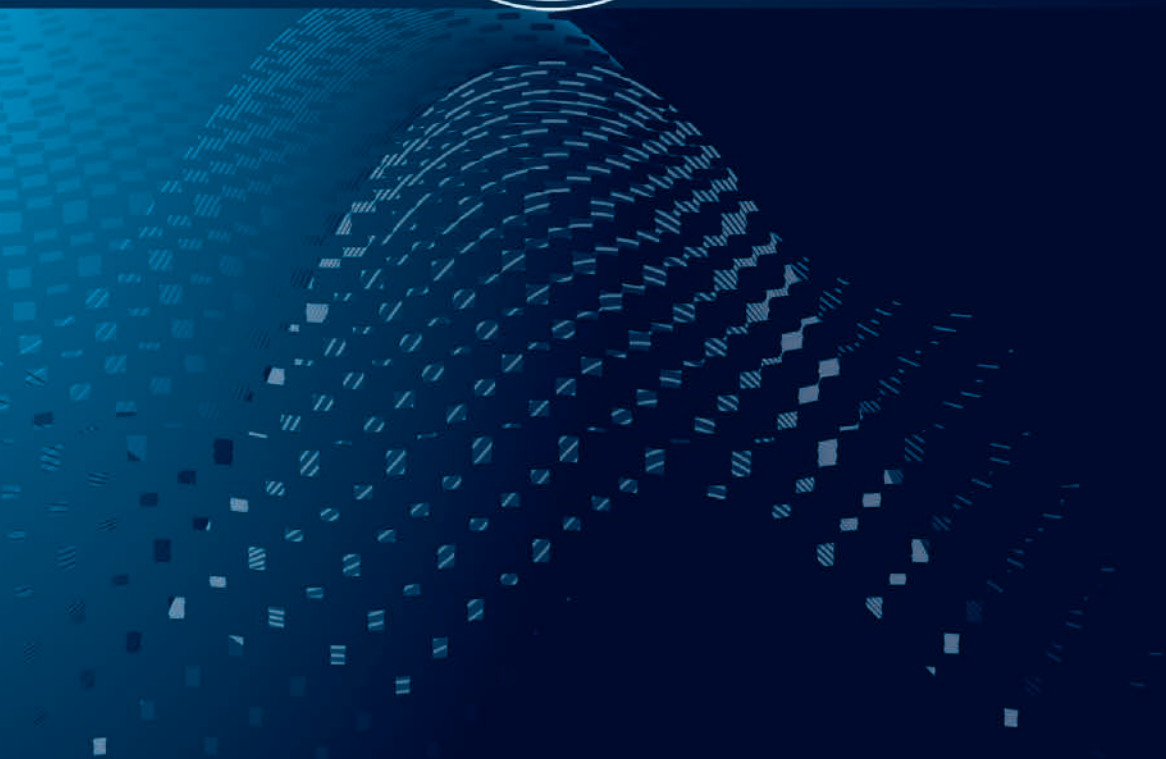
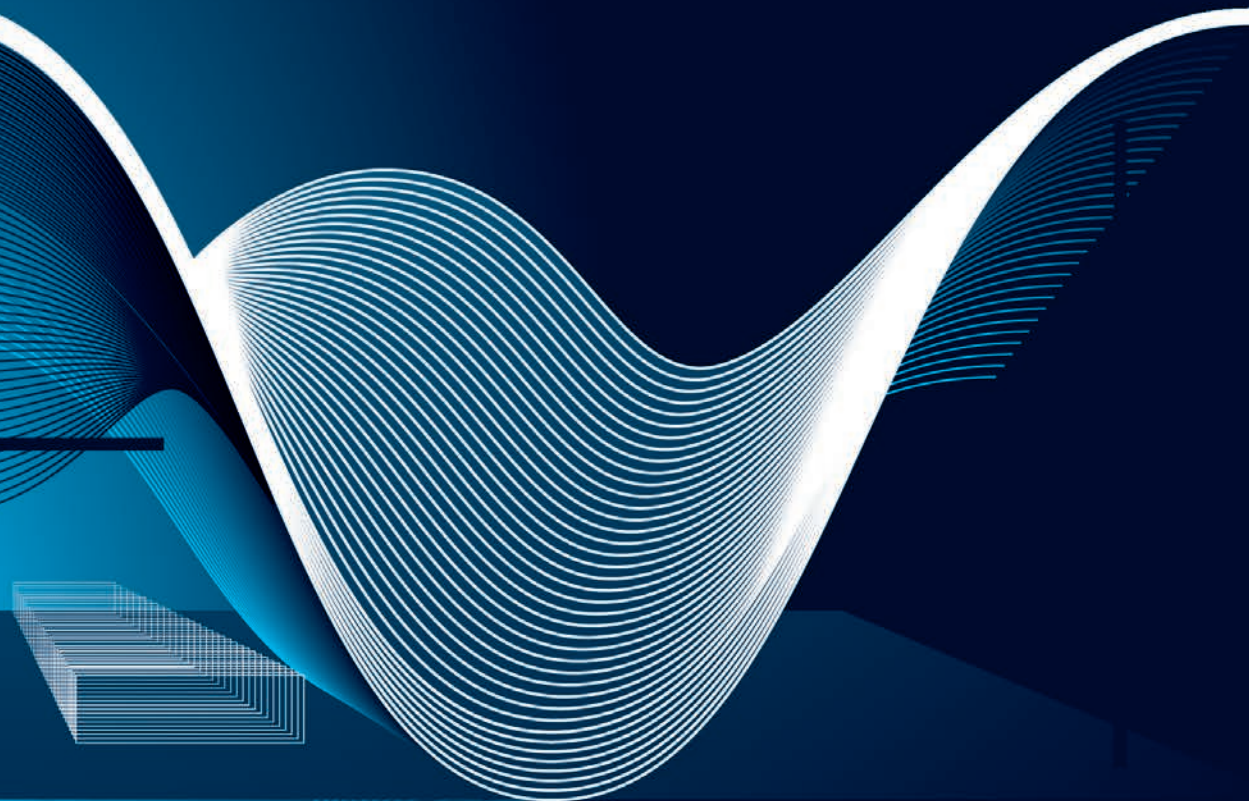



# WOODEN/LVT

COLOURS  
STANDARD AND ON DEMAND

For a precise assessment of colours request the wooden finishes sample range.  
For sample finishes, contact the sales office for minimum quantities, timing and costs.

## WOOD COLOURS

wooden finishes	Promultifix	SOL 40P Zero Curve Terminal Pin	Terminal	Style Stair	Style Stair L	LVT	Prowalk	SOL 30	Procover wood	Profixer line		7011	Multiskirting round/square	Skirting 40
04W	*	●	*	*	●	*	*	*	*	●	●	*	*	*
05W	●	●	●	●	●	●	*	●	●	●	●	●	*	*
06W	*	*	*	*	*	*	*	*	*	*	*	*	*	*
07W	●	●	*	●	*	*	*	*	*	●	*	●	*	*
08W	*	*	*	*	*	*	*	*	*	*	*	*	*	*
09W	●	●	●	●	*	●	*	●	*	●	*	●	*	*
10W	*	*	*	*	*	*	*	*	*	*	*	*	*	*
11W	*	*	*	*	*	*	*	*	●	*	*	*	*	*
13W	*	●	*	*	●	●	*	●	*	●	●	*	*	*
18W	●	●	●	●	●	●	*	●	*	●	●	●	*	*
21W	●	●	●	●	●	●	*	●	*	●	●	●	*	*
25W	*	●	*	*	●	●	*	●	*	●	●	*	●	●
28W	*	*	*	*	*	*	*	*	●	*	*	*	*	*
29W	●	●	●	●	●	●	*	●	●	●	●	●	●	●
30W	●	●	●	●	●	●	*	*	●	●	●	●	●	●
31W	●	●	●	●	●	●	*	*	*	●	●	●	*	*
32W	●	●	*	●	●	*	*	*	*	●	●	●	*	*
33W	*	●	*	*	●	●	*	*	*	●	●	*	*	*
34W	●	●	●	●	●	●	*	*	*	●	●	●	●	●
35W	●	●	*	●	●	*	*	*	*	●	●	●	*	*
36W	*	●	*	*	●	●	*	*	*	●	●	*	*	*
37W	●	●	●	●	●	●	*	*	*	●	●	●	*	*
38W	*	●	*	*	●	●	*	*	*	●	●	*	*	*
39W	*	●	*	*	●	●	*	*	*	●	●	*	*	*
40W	*	*	*	*	*	*	*	*	*	*	*	●	*	*
41W	●	●	●	●	●	●	*	*	*	●	●	●	*	*
42W	●	●	●	●	●	●	*	*	*	●	●	●	*	*
43W	*	*	*	*	*	●	*	*	*	*	*	●	*	*
44W	●	●	●	●	●	●	*	*	*	●	●	●	*	*
45W	*	●	*	*	●	●	*	*	*	●	●	*	*	*
46W	●	●	●	●	*	●	*	*	*	●	*	●	*	*
47W	*	*	*	*	*	●	*	*	*	*	*	●	*	*
48W	●	●	*	●	*	●	*	*	*	●	*	●	*	*
49W	●	●	*	●	*	●	*	*	*	●	*	●	*	*
50W	*	*	*	*	*	*	*	*	*	*	*	*	*	*
51W	*	*	*	*	*	*	*	*	*	*	*	*	*	*
52W	*	*	*	*	*	*	*	*	*	*	*	*	*	*
53W	*	●	*	*	●	*	*	*	*	●	●	*	*	*
54W	*	●	*	*	●	*	*	*	*	●	●	*	*	*
55W	*	●	*	*	●	*	*	*	*	●	●	*	*	*
56W	*	*	*	*	*	*	*	*	*	*	*	*	*	*
57W	*	*	*	*	*	*	*	*	*	*	*	*	*	*
58W	*	*	*	*	*	*	*	*	*	*	*	*	*	*

wooden finishes	Promultifix	SOL 40P Zero Curve Terminal Pin	Terminal	Style Stair	Style Stair L	LVT	Prowalk	SOL 30	Procover wood	Profixer line		7011	Multiskirting round/square	Skirting 40
59W	*	*	*	*	*	*	*	*	*	*	*	*	*	*
60W	*	*	*	*	*	*	*	*	*	*	*	*	*	*
61W	*	*	*	*	*	*	*	*	*	*	*	*	*	*
62W	*	*	*	*	*	*	*	*	*	*	*	*	*	*
63W	*	*	*	*	*	*	*	*	*	*	*	*	*	*
64W	*	*	*	*	*	*	*	*	*	*	*	*	*	*
65W	●	●	*	●	*	*	*	*	*	●	*	●	*	*
66W	*	*	*	*	*	*	*	*	*	*	*	*	*	*
67W	*	*	*	*	*	*	*	*	*	*	*	*	*	*
68W	*	*	*	*	*	*	*	*	*	*	*	*	*	*
69W	*	*	*	*	*	*	*	*	*	*	*	*	*	*
70W	*	*	*	*	*	*	*	*	*	*	*	*	*	*
71W	*	*	*	*	*	*	*	*	*	*	*	*	*	*
72W	*	*	*	*	*	*	*	*	*	*	*	*	*	*
73W	●	●	*	●	*	*	*	*	*	●	*	●	*	*
74W	*	*	*	*	*	*	*	*	*	*	*	*	*	*
75W	●	●	*	●	*	*	*	*	*	●	*	●	*	*
76W	*	*	*	*	*	*	*	*	*	*	*	*	*	*
77W	*	*	*	*	*	*	*	*	*	*	*	*	*	*
78W	*	*	*	*	*	*	*	*	*	*	*	*	*	*
79W	*	*	*	*	*	*	*	*	*	*	*	*	*	*
80W	*	*	*	*	*	*	*	*	*	*	*	*	*	*
81W	*	*	*	*	*	*	*	*	*	*	*	*	*	*
82W	*	*	*	*	*	*	*	*	*	*	*	*	*	*
83W	*	*	*	*	*	*	*	*	*	*	*	*	*	*
84W	*	*	*	*	*	*	*	*	*	*	*	*	*	*
85W	*	*	*	*	*	*	*	*	*	*	*	*	*	*
86W	*	*	*	*	*	*	*	*	*	*	*	*	*	*
87W	*	*	*	*	*	*	*	*	*	*	*	*	*	*
88W	*	*	*	*	*	*	*	*	*	*	*	*	*	*
89W	*	*	*	*	*	*	*	*	*	*	*	*	*	*
90W	*	*	*	*	*	*	*	*	*	*	*	*	*	*
91W	*	*	*	*	*	*	*	*	*	*	*	*	*	*
93W	●	*	*	*	*	●	*	*	*	*	*	*	*	*
94W	*	*	*	*	*	*	*	*	*	*	*	*	*	*
95W	*	*	*	*	*	*	*	*	*	*	*	*	*	*
97W	*	*	*	*	*	*	*	*	*	*	*	*	*	*
AA	X	X	X	X	X	X	X	X	*	*	●	●	●	●
B	X	X	X	X	X	X	X	X	X	X	●	●	●	●
N	X	X	X	X	X	X	X	X	X	X	●	*	●	●

● = Available finishes

X = Not available finishes

\* = minimum order 200 pcs. Production delay 4/5 weeks. Price to be agreed.

# WOODEN/LVT

COLOURS  
STANDARD AND ON DEMAND

For a precise assessment of colours request the wooden finishes sample range.  
For sample finishes, contact the sales office for minimum quantities, timing and costs.

## WOOD COLOURS

04W - Dark beech	05W - Light oak (strip)	06W - Dark oak (Walnut)	07W - Light cherry (strip)	08W - Dark cherry (board)	09W - Red walnut	10W - Wengè	11W - Decapè bleached	13W - Indonesian teak
18W - Light zerbano	21W - Oak powder	25W - Bleached fir	28W - Aspen oak	29W - White oak	30W - Grey oak	31W - Victoria oak	32W - Pink oak	33W - Sawed oak
34W - Havana oak	35W - Edinburgh oak	36W - American oak	37W - Carvi oak	38W - Queens oak	39W - Grey elm	40W - Brown oak	41W - Ice oak	42W - Grace oak
43W - Manhattan oak	44W - Honey oak	45W - Marocco oak	46W - Black decapè	47W - Black oak	48W - Cork oak	49W - Sand oak	50W	51W
52W	53W	54W	55W	56W	57W	58W	59W	60W
61W	62W	63W	64W	65W - Tripoli	66W	67W	68W	69W
70W	71W	72W	73W - Bangkok	74W	75W - Liotard	76W	77W	78W
79W	80W	80W	82W	83W	84W	85W	86W	87W
88W	89W	90W	93W - New white	94W	95W	97W		

## EXTRUDED EXPANDED PVC COLOURS

B - White	GC - Light grey	GS - Dark grey	N - Black
04W - Dark beech	05W - Light Oak	06W - Dark Oak	07W - Light cherry
08W - Dark cherry	09W - Red Walnut	10W - Wengè	M - Mahogany

Extruded Expanded PVC	Proseal wood	Proangle wood	Skirting	Angle bar
B (White)	●	●	●	●
GC (Light Grey)	●	●	●	●
GS (Dark Grey)	●	●	●	●
N (Black)	●	●	●	●
04W (Dark Beech)	X	X	●	●
05W (Light Oak)	●	●	●	●
06W (Dark Oak)	X	X	●	●
07W (Light cherry)	X	X	●	●
08W (Dark cherry)	X	X	●	●
09W (Red Walnut)	X	X	●	●
10W (Wengè)	●	●	●	●
M (Mahogany)	X	X	●	●

## ANODIZED COLOURS

AO - Anod. gold aluminium	AA - Anod. silver aluminium	AB - Anod. bronze aluminium	AT - Anod. titanium aluminium
CH - Anod. champagne alum.	SB - Anod. sand aluminium		

Anodized Aluminium Colours	Promultifix	SOL 40P Zero Curve Terminal Pin	Terminal	Style Stair	Style Stair L	LVT	Prowalk	Prostep Ins	SOL 30	Profixer line	Proscrow
AO (anod. gold)	●	●	●	●	●	●	●	●	●	●	●
AA (anod. silver)	●	●	●	●	●	●	●	X	*	●	*
AB (anod. bronze)	●	●	●	●	●	●	●	X	*	●	*
AT (anod. titanium)	*	*	*	*	*	*	*	X	*	*	*
CH (anod. champagne)	*	*	*	*	*	*	*	X	*	*	*
SB (anod. sand)	*	*	*	*	*	*	*	X	*	*	*

● = Available finishes

X = Not available finishes

\* = minimum order 200 pcs. Production delay 4/5 weeks. Price to be agreed.



# PROMULTIFIX SYSTEM®

**PATENTED**

## INSTRUCTIONS FOR LAYING

**PROGRESS PROFILES®** has filed an innovative patent PROMULTIFIX SYSTEM® in respect of a wide range of aluminum profiles covered with very strong films in wooden finishes, plus anodized finishes.

The PROMULTIFIX SYSTEM® system is a multipurpose profile for finishing laminate, melamine-coated, parquet and wood floating floors.

**FIXING:** it can be fixed with adhesive, nylon anchors, glue, flatten down base and screws.

**STANDARD Wooden FINISHES:** Light oak (strip), Light cherry (strip), Red walnut (merbau-apple-walnut), Light zerbano, Oak powder, White oak, Grey oak, Victoria oak, Pink oak, Havana oak, Edinburgh oak, Carvi oak, Ice oak, Grace oak, Honey oak, Black decape', Cork oak, Sand oak, Tripoli, Bangkok, Liotard, New white.

**STANDARD ALUMINUM FINISHES:** anodized Silver, Gold and Bronze.

### ANODIZED COLOURS



### \* ANODIZED COLOURS ON DEMAND



### WOODEN COLOURS

(For a precise assessment of colours request the wooden finishes sample range)

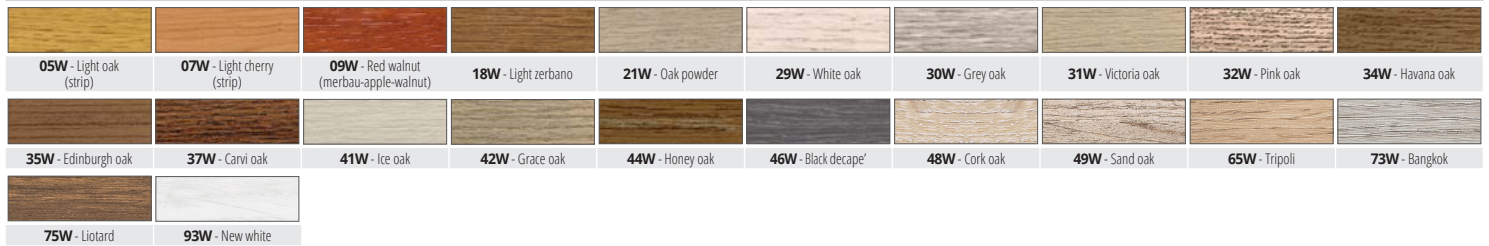

### \* WOODEN COLOURS ON DEMAND



On request it is possible to realize other finishes of the color range: minimum order 200 pcs. Production delay 4/5 weeks. Price to be agreed. For sample finishes, contact the sales office for minimum quantities, timing and costs.

## PROMULTIFIX SYSTEM

PROMULTIFIX SYSTEM is composed of an aluminium profile with adhesive, with a lengthwise groove in form of dovetail, where nylon anchors can be inserted, or a punched aluminium flatten down base for an easy and invisible fixing.

### NYLON SCREW ANCHORS



### PERIMETRIC SUPPORTS



### FLATTEN DOWN BASE



\* = Article on demand minimum order 200 pcs. Production delay 4/5 weeks. Price to be agreed.



It is a system composed of a special TOP with adhesive, with a visible surface of 44.7 mm, anodized aluminium or covered with wooden film. The aluminium TOP can be fixed to the floor in different ways: with adhesive, with nylon anchors, support with removable spacers, flatten down base.

# PROMULTIFIX SYSTEM

ALUMINIUM PROFILES  
FIXING KIT



**TOP IN ANOD. ALUMINIUM with adhesive** (6 finishes of which 3 on demand) + n.3 KIT (15 screws, 12 perimeter pins, 6 joints) thermo packed - bar length 2,7 lm - pack. 20 Pcs - 54 lm

Article	L mm
PMPFX... 42A	44,7

**TOP IN ANOD. ALUMINIUM with adhesive** (6 finishes of which 3 on demand) + n.1 KIT (5 screws, 4 perimeter pins, 2 joints) thermo packed - bar length 0,90 lm - 15 Pcs

Article	L mm
PMPFX... 42090AS	44,7

**TOP IN ALUM. COVERED with adhesive** (80 wooden finishes of which 59 on demand) + n.3 KIT (15 screws, 12 perimeter pins, 6 joints) thermo packed - bar length 2,7 lm - pack. 20 Pcs - 54 lm

Article	L mm
PMPFX... 42A	44,7

**TOP IN ALUM. COVERED with adhesive** (80 wooden finishes of which 59 on demand) + n.1 KIT (5 screws, 4 perimeter pins, 2 joints) thermo packed - bar length 0,90 lm - 15 Pcs

Article	L mm
PMPFX... 42090AS	44,7

Available in the colours: AO - AA - AB (AT, CH and SB on demand with a minimum quantity order of 200 pcs) and in the wooden finishes: 05W - 07W - 09W - 18W - 21W - 29W - 30W - 31W - 32W - 34W - 35W - 37W - 41W - 42W - 44W - 46W - 48W - 49W - 65W - 73W - 75W - 93W. The code of the selected colour must be added to the article code. E.g.: PMPFX... 42A (chosen finish anod. gold) PMPFXAO 42A.

## EXAMPLES AND INSTRUCTIONS FOR LAYING METHODS

1. Choose the profile of the required finish, if necessary cut the TOP in the required length.
2. Clean, remove the grease and dry the substrate: the temperature should be at least of 15° C.
- Fixing with biadhesive tape:**
3. Remove the paper protection from the adhesive and lay the TOP with a vertical pressure without moving the profile.
- Fixing with screw anchors:**
3. Drill the substrate with a 6 mm bit, 5 holes per linear meter. 4. Remove the paper protection from the adhesive. 5. Insert the screw anchors in the profile dovetail groove. 6. Beat with a rubber/pvc hammer to insert the screw anchors into the holes.
- Fixing of the aluminium flatten down base:**
3. Cut the flatten down base to the requested length. 4. Remove the paper protection from the adhesive. 5. insert the base into the profile groove dovetail, then fix or glue the base to the floor. 6. Make a uniform pressure on the profile with the hands or a rubber hammer.
- Perimetric laying:**
3. Remove the paper protection from the adhesive. 4. Cut the perimetric pins according to the thickness of the floor. 5. Insert the perimetric pins into the profile groove dovetail using 4 supports per linear meter. 6. Fix the profil making a uniform pressure on the profile with the hands, but do not move the profile.

One fixing kit is composed of: 5 screws, 4 perimetric pins, 2 joints

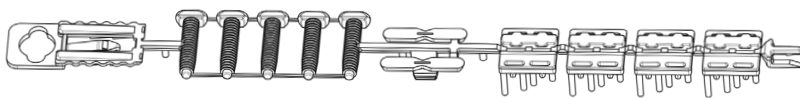

PMPFX... 42090AS / 42A

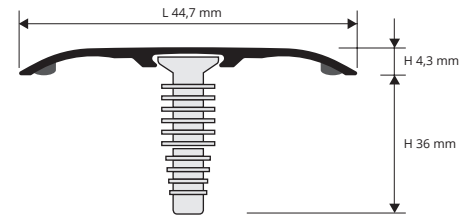

PMPFX... 42090AS / 42A

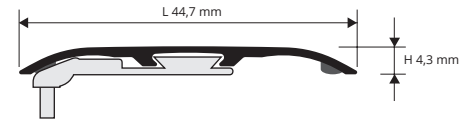

PMPFX... 42090AS / 42A + PMFIXBSAN 23

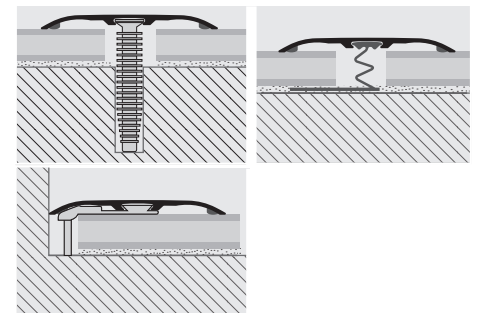
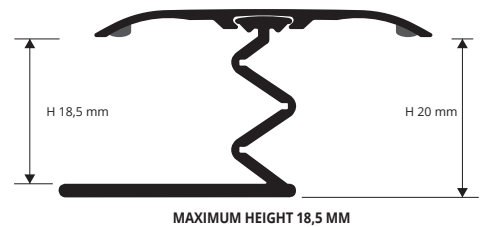

## SCREWS AND SCREW ANCHORS, TAP-DOWN BASE

### NICKEL - PLATED FLATHEAD SCREWS + SCREW ANCHORS

pack. 1.000 Pcs

Article	Ø mm	L mm
VINIPT 325	3	25

### PROFIXER TAP-DOWN BASE - ALUM. PUNCHED/PERFORED

bar length 2,7 lm - pack. 20 Pcs - 54 lm

Article	H mm
PMFIXBSAN 23	23

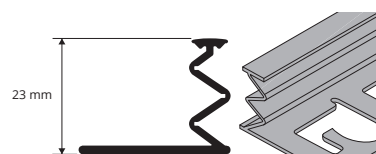
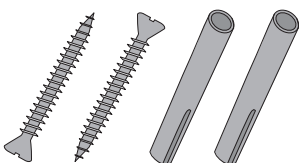



**PROGRESS® PROFILES** has filed an innovative patent PROINSERT SYSTEM in respect of a wide range of aluminum profiles covered with very strong films in 77 wooden finishes are available, plus 6 anodized finishes.

The **PROINSERT SYSTEM** system comprises a complete set of profiles for finishing laminate, melamine-coated, parquet and wood floating floors.

**INTERCHANGEABLE INSERTS** in 7 heights: (H 07, 09, 11, 13, 15, 17 and 19 mm). **PROFILES COVERED** with film: resistant to wear and UV rays (classe AC1). **TWO VERSATILE VERSIONS OF BASES:** available for fixing with glue or screws.

### INSTRUCTIONS FOR LAYING:



1) Choose between the two types of aluminum base.



2) Fix and/or glue the base to the floor.

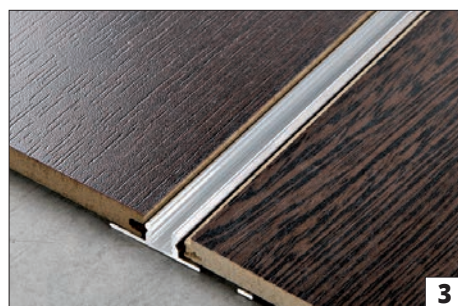

3) Lay the floor correctly leaving between 3 and 10 mm gap for the natural expansion of the wood.

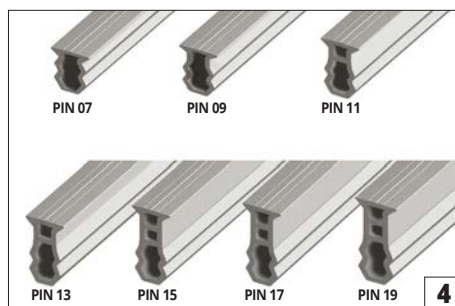

4) Choose the vinyl resin insert according to the clear height and thickness of the floor.



5) Keep the profile with the groove for insertion facing upwards and slot in the insert from the top downwards (if it does not slide easily, lubricate with water, silicone spray or vegetable oil).

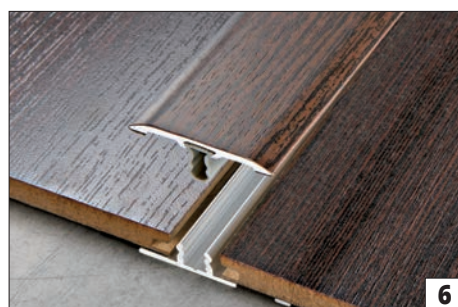

6) Place the profile over the "U" shaped channel.



7) With the help of a wooden tapping block, apply pressure evenly over the whole length of the profile using a hammer. If tapping is done correctly, a "click" will be heard when the profile slots into place.

### THESE PROFILES ARE APPLIED TO CREATE:

- Threshold covers and expansion joints (SOL 30, SOL 40P and SOL 50)
- Transition joints for differences in level and floors in differing materials and thickness (ZERO CURVE)
- Perimeter joints or terminal expansion pieces (TERMINAL PIN)
- Corner joints and step nosings (serie STYLE STAIR)

#### SOL 30, SOL 40P AND SOL 50



#### ZERO CURVE



#### TERMINAL PIN

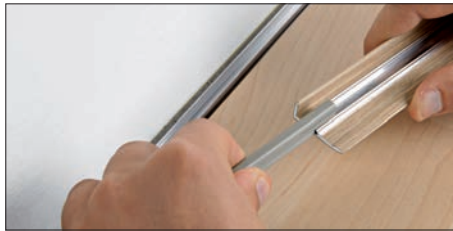

#### STYLE STAIR / STYLE STAIR L

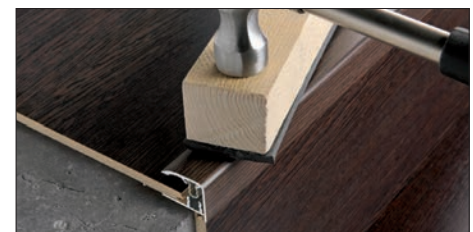

### PROFIXER LINE SYSTEM

The **PROFIXER LINE SYSTEM** comprises an assortment of profiles in aluminum with a longitudinal dovetail groove/channel into which the anchors or the tap-down punched/perforated aluminum profile may be inserted for easy and invisible fixing.

#### NYLON SCREW ANCHORS



#### TAP-DOWN BASE





**SOL 40P** range comprises a large assortment of universal jointing profiles in aluminium covered with film that is highly resistant to pedestrian traffic, wear, UV rays and commonly used floor cleaning products. Thanks to the insert in rigid PVC (non-conducting) between the base and the top, the new **SOL 40P** stops and eliminates electrostatic charges and magnetic fields and whatever else may be transmitted between two floors (e.g.: heated floors). available in wooden finishes, plus anodized finishes. Any insert of height H 7, 9, 11, 13, 15, 17 and 19 mm may be used with either the punched/perforated base for screwing or for gluing. Covering width 40 mm.

# SOL 40P

TOP IN WOODEN OR ANODIZED FINISHES  
+ PIN INSERT + ALUMINIUM BASE



**ALUM. TOP + PIN INSERT + ALUM. BASE 45 PUNCHED/PERFORED**  
(6 anod. alum. finishes of which 3 on demand) thermo packed  
bar length 2,7 lm - pack. 20 Pcs - 54 lm (PIN 17, 19 - 40,5 lm)

Article	H mm
PISPC... 407 (PIN 07)	7 / 10
PISPC... 409 (PIN 09)	9 / 12
PISPC... 4011 (PIN 11)	11 / 14
PISPC... 4013 (PIN 13)	13 / 16
PISPC... 4015 (PIN 15)	15 / 18
PISPC... 4017 (PIN 17)	17 / 20
PISPC... 4019 (PIN 19)	19 / 22

COMPLETE

**ALUM. TOP + PIN INSERT + ALUM. BASE 45 PUNCHED/PERFORED**  
(6 anod. alum. finishes of which 3 on demand) thermo packed  
length 0,90 lm - 15 Pcs (PIN 13, 15, 17, 19 - 10 Pcs)



Article	H mm
PISPC... 4079S (PIN 07)	7 / 10
PISPC... 4099S (PIN 09)	9 / 12
PISPC... 40119S (PIN 11)	11 / 14
PISPC... 40139S (PIN 13)	13 / 16
PISPC... 40159S (PIN 15)	15 / 18
PISPC... 40179S (PIN 17)	17 / 20
PISPC... 40199S (PIN 19)	19 / 22

**ALUM. TOP COVERED + PIN INSERT + ALUM. BASE 45 PUNCHED/PERFORED**  
(80 wooden finishes of which 49 on demand) thermo packed  
bar length 2,7 lm - pack. 20 Pcs - 54 lm (PIN 17, 19 - 40,5 lm)

Article	H mm
PISPC... 407 (PIN 07)	7 / 10
PISPC... 409 (PIN 09)	9 / 12
PISPC... 4011 (PIN 11)	11 / 14
PISPC... 4013 (PIN 13)	13 / 16
PISPC... 4015 (PIN 15)	15 / 18
PISPC... 4017 (PIN 17)	17 / 20
PISPC... 4019 (PIN 19)	19 / 22

COMPLETE

**ALUM. TOP COVERED + PIN INSERT + ALUM. BASE 45 PUNCHED/PERFORED**  
(80 wooden finishes of which 49 on demand) thermo packed  
length 0,90 lm - 15 Pcs (PIN 13, 15, 17, 19 - 10 Pcs)



Article	H mm
PISPC... 4079S (PIN 07)	7 / 10
PISPC... 4099S (PIN 09)	9 / 12
PISPC... 40119S (PIN 11)	11 / 14
PISPC... 40139S (PIN 13)	13 / 16
PISPC... 40159S (PIN 15)	15 / 18
PISPC... 40179S (PIN 17)	17 / 20
PISPC... 40199S (PIN 19)	19 / 22

Available in the finishes: AO - AA - AB (AT, CH and SB available on demand with a minimum quantity order of 200 pcs) and in the wooden finishes: 04W - 05W - 07W - 09W - 13W - 18W - 21W - 25W - 29W - 30W - 31W - 32W - 33W - 34W - 35W - 36W - 37W - 38W - 39W - 41W - 42W - 44W - 45W - 46W - 48W - 49W - 53W - 54W - 55W - 65W - 73W - 75W.

The code of the selected colour must be added to the article code. E.g.: PISPC... 4079S (chosen finish anod. gold) PISPCAO 4079S.

## ANODIZED COLOURS



## \* ANODIZED COLOURS ON DEMAND



## WOODEN COLOURS

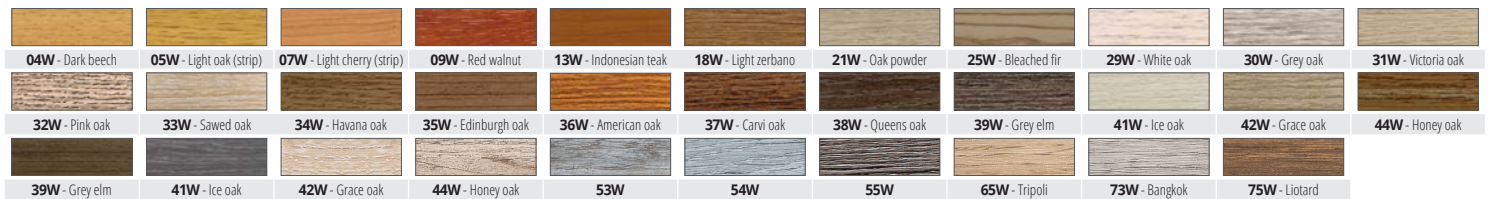

## \* WOODEN COLOURS ON DEMAND

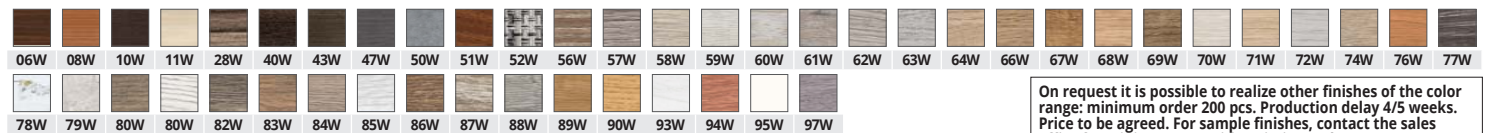

On request it is possible to realize other finishes of the color range: minimum order 200 pcs. Production delay 4/5 weeks. Price to be agreed. For sample finishes, contact the sales office for minimum quantities, timing and costs.

## EXAMPLES AND INSTRUCTIONS FOR LAYING METHODS

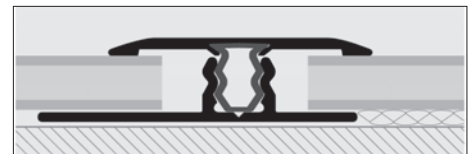

1. Fix and/or glue the base to the floor. 2. Lay the floor leaving from 3 to 10 mm between the floor and the insert. 3. Choose the desired profile, if necessary cut TOP, PIN and BASE at the needed length and then insert the PIN in the TOP in the specific "dovetail" seat. The position the profile above the U-shaped snap-in seat of the base. 4. With the aid of a board, hammer the TOP to the desired fitting level.

\* = Production on demand with minimum quantity of 200 pcs. Production delay 4/5 weeks. Price to be agreed

# ZERO CURVE

TOP IN WOODEN FINISHES  
AND ANODIZED FINISHES  
+ PIN INSERT + ALUMINIUM BASE

The **ZERO CURVE** range comprises a large assortment of terminal transition profiles for joining floors at different levels and with different thickness varying from 7 to 20 mm. wooden finishes are available, plus anodized finishes. There is a profile (top) and an insert (pin) for each height, while the base (punched or perforated) allows fixing by screwing or gluing.

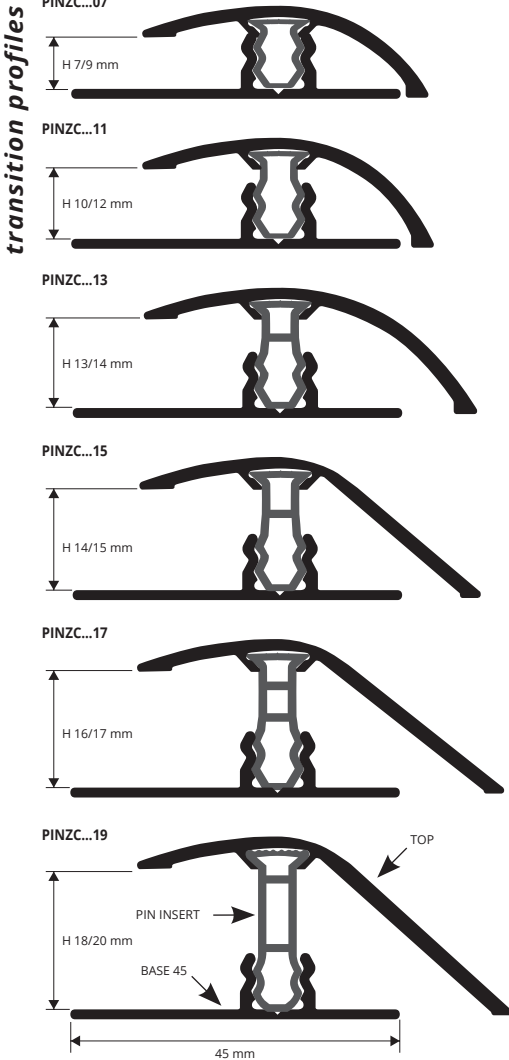

**ALUM. TOP + PIN INSERT + ALUM. BASE 45 PUNCHED/PERFORED**  
(6 anod. alum. finishes of which 3 on demand) thermo packed  
bar length 2,7 lm - pack. 20 Pcs - 54 lm - (PIN 15, 17 - 40,5 lm) (PIN 19 - 27 lm)

Article	H mm
PINZC... 07 (top PINZ... 07 + PIN 07)	7 / 9
PINZC... 11 (top PINZ... 07 + PIN 11)	10 / 12
PINZC... 13 (top PINZ... 09 + PIN 13)	13 / 14
PINZC... 15 (top PINZ... 13 + PIN 15)	14 / 15
PINZC... 17 (top PINZ... 13 + PIN 17)	16 / 17
PINZC... 19 (top PINZ... 15+ PIN 19)	18 / 20

COMPLETE

**ALUM. TOP + PIN INSERT + ALUM. BASE 45 PUNCHED/PERFORATED**  
(6 anod. alum. finishes of which 3 on demand) thermo packed  
L. 0,90 lm - 15 Pcs (PIN 13, 15, 17, 19 - 10 Pcs)

Article	H mm
PINZC... 07S (top PINZ... 07 + PIN 07)	7 / 9
PINZC... 11S (top PINZ... 07 + PIN 11)	10 / 12
PINZC... 13S (top PINZ... 09 + PIN 13)	13 / 14
PINZC... 15S (top PINZ... 13 + PIN 15)	14 / 15
PINZC... 17S (top PINZ... 13 + PIN 17)	16 / 17
PINZC... 19S (top PINZ... 15+ PIN 19)	18 / 20



Available in the finishes: AO - AA - AB (AT, CH and SB available on demand with a minimum quantity order of 200 pcs) and in the wooden finishes: 04W - 05W - 07W - 09W - 13W - 18W - 21W - 25W - 29W - 30W - 31W - 32W - 33W - 34W - 35W - 36W - 37W - 38W - 39W - 41W - 42W - 44W - 45W - 46W - 48W - 49W - 53W - 54W - 55W - 65W - 73W - 75W.

The code of the selected colour must be added to the article code. E.g.: PINZC... 07S (chosen finish anod. gold) PINZCAO 07S.

**ALUM. TOP COVERED + PIN INSERT + ALUM. BASE 45 PUNCHED/PERFORED**  
(80 wooden finishes of which 49 on demand) thermo packed  
bar length 2,7 lm - pack. 20 Pcs - 54 lm - (PIN 15, 17 - 40,5 lm) (PIN 19 - 27 lm)

Article	H mm
PINZC... 07 (top PINZ... 07 + PIN 07)	7 / 9
PINZC... 11 (top PINZ... 07 + PIN 11)	10 / 12
PINZC... 13 (top PINZ... 09 + PIN 13)	13 / 14
PINZC... 15 (top PINZ... 13 + PIN 15)	14 / 15
PINZC... 17 (top PINZ... 13 + PIN 17)	16 / 17
PINZC... 19 (top PINZ... 15+ PIN 19)	18 / 20

COMPLETE

**ALUM. TOP COVERED + PIN INSERT + ALUM. BASE 45 PUNCHED/PERFORED**  
(80 wooden finishes of which 49 on demand) thermo packed  
L. 0,90 lm - 15 Pcs (PIN 13, 15, 17, 19 - 10 Pcs)

Article	H mm
PINZC... 07S (top PINZ... 07 + PIN 07)	7 / 9
PINZC... 11S (top PINZ... 07 + PIN 11)	10 / 12
PINZC... 13S (top PINZ... 09 + PIN 13)	13 / 14
PINZC... 15S (top PINZ... 13 + PIN 15)	14 / 15
PINZC... 17S (top PINZ... 13 + PIN 17)	16 / 17
PINZC... 19S (top PINZ... 15+ PIN 19)	18 / 20



## ANODIZED COLOURS



## \* ANODIZED COLOURS ON DEMAND



## WOODEN COLOURS



## \* WOODEN COLOURS ON DEMAND



On request it is possible to realize other finishes of the color range: minimum order 200 pcs. Production delay 4/5 weeks. Price to be agreed. For sample finishes, contact the sales office for minimum quantities, timing and costs.

## EXAMPLES AND INSTRUCTIONS FOR LAYING METHODS



1. Fix and/or glue the base to the floor. 2. Lay the floor leaving from 3 to 10 mm between the floor and the insert. 3. Choose the desired profile, if necessary cut TOP, PIN and BASE at the needed length and then insert the PIN in the TOP in the specific "dovetail" seat. The position the profile above the U-shaped snap-in seat of the base. 4. With the aid of a board, hammer the TOP to the desired fitting level.

\* = Article on demand minimum order 200 pcs. Production delay 4/5 weeks. Price to be agreed.



# TERMINAL PIN

TOP IN WOODEN FINISHES  
AND ANODIZED FINISHES  
+ PIN INSERT + ALUMINIUM BASE

The **TERMINAL PIN** series consists in a wide range of terminal/ outer joint squares ideal to realize the connection and junction with floors in laminate or melamine and/or wood/parquet rolled floor. The **TERMINAL PIN** allows the floor underneath to expand for more than 5 / 10 mm. It prevents from the use of the skirting -board and covers perfectly any kind of floor with a minimum thickness of 7 mm and a maximum of 22 mm. It delimitates the floor in proximity of walls, coverings, windows, doors, sliding doors, doormats buss etc.

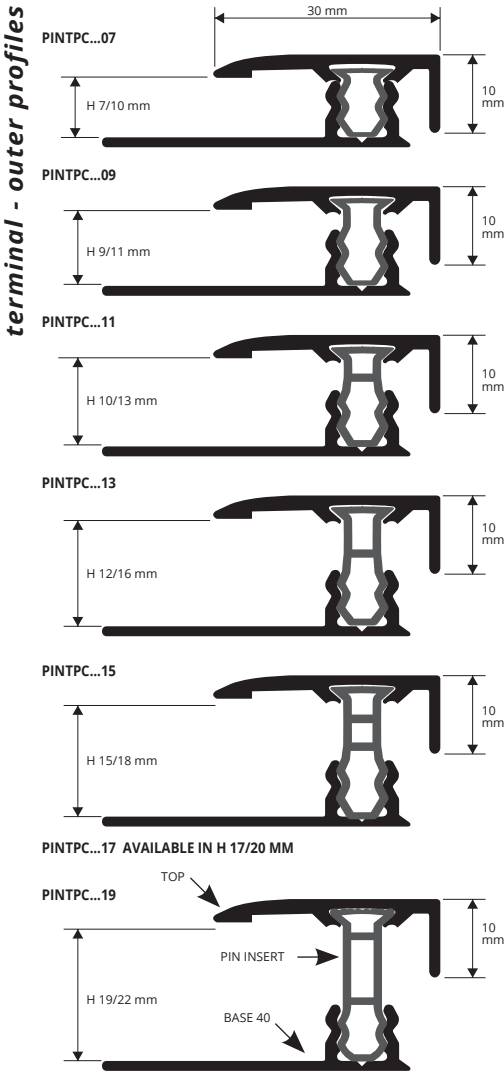

ALUM. TOP + PIN INSERT + ALUM. BASE 40 PUNCHED/PERFORATED (6 anod. alum. finishes of which 3 on demand) thermo packed bar length 2,7 lm - pack. 20 Pcs - 54 lm (PIN 11, 15, 17 - 40,5 lm) (PIN 19 - 27 lm)

Article	H mm
PINTPC... 07 (PIN 07)	7 / 10
PINTPC... 09 (PIN 09)	9 / 11
PINTPC... 11 (PIN 11)	10 / 13
PINTPC... 13 (PIN 13)	12 / 16
PINTPC... 15 (PIN 15)	15 / 18
PINTPC... 17 (PIN 17)	17 / 20
PINTPC... 19 (PIN 19)	19 / 22

COMPLETE

ALUM. TOP + PIN INSERT + ALUM. BASE 40 PUNCHED/PERFORATED (6 anod. alum. finishes of which 3 on demand) thermo packed L. 0,90 lm - 15 Pcs (PIN 13, 15, 17, 19 - 10 Pcs)

Article	H mm
PINTPC... 07S (PIN 07)	7 / 10
PINTPC... 09S (PIN 09)	9 / 11
PINTPC... 11S (PIN 11)	10 / 13
PINTPC... 13S (PIN 13)	12 / 16
PINTPC... 15S (PIN 15)	15 / 18
PINTPC... 17S (PIN 17)	17 / 20
PINTPC... 19S (PIN 19)	19 / 22

Available in the finishes: AO - AA - AB (AT, CH and SB available on demand with a minimum quantity order of 200 pcs) and in the wooden finishes: 04W - 05W - 07W - 09W - 13W - 18W - 21W - 25W - 29W - 30W - 31W - 32W - 33W - 34W - 35W - 36W - 37W - 38W - 39W - 41W - 42W - 44W - 45W - 46W - 48W - 49W - 53W - 54W - 55W - 65W - 73W - 75W.

The code of the selected colour must be added to the article code. E.g.: PINTPC... 07S (chosen finish anod. gold) PINTPCAO 07S.

ANODIZED COLOURS

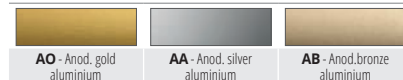

\*ANODIZED COLOURS ON DEMAND

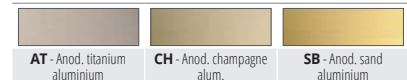

WOODEN COLOURS



\* WOODEN COLOURS ON DEMAND

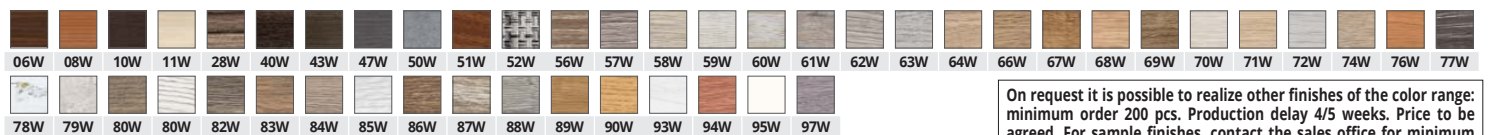

On request it is possible to realize other finishes of the color range: minimum order 200 pcs. Production delay 4/5 weeks. Price to be agreed. For sample finishes, contact the sales office for minimum quantities, timing and costs.

EXAMPLES AND INSTRUCTIONS FOR LAYING METHODS



1. Fix PINBFTL 40 base at the outer edge/wall. 2. Align the laminate/melamine/wood floor, ensuring that approx. 3/10mm gap is left on each side to accommodate the natural expansion between the floor and the base.
3. Choose the desired profile, if necessary cut TOP, PIN and BASE at the needed length and then insert the PIN in the TOP in the specific "dovetail" seat. The position the profile above the U-shaped snap-in seat of the base.
4. With the aid of a board, hammer the TOP to the desired fitting level.

\* = Article on demand minimum order 200 pcs. Production delay 4/5 weeks. Price to be agreed.





The **TERMINAL** range comprises a large assortment of perimeter joint or edging profiles in aluminium covered in wooden finishes are available, plus anodized finishes. They are used in various laying situations. Ideal as an edging profile for wood parquet, laminate and melamine-coated floors. They finish the floor where it joins to abutting surfaces, windows, glazed areas, doors, terraces and may also be used for joining two floors: wood/tiles, wood/ carpeting.

# TERMINAL

ALUMINIUM COVERED WOODEN FINISHES AND ANODIZED FINISHES



**ANODIZED ALUMINIUM (6 anod. alum. finishes of which 3 on demand)**  
thermo packed - bar length 2,7 lm - pack. 40 Pcs - 108 lm  
(H 11 - H 13 - H 15 mm - 80 lm)

Article	H mm
PINT... 07	7
PINT... 09	9
PINT... 11	11
PINT... 13	13
PINT... 15	15

Available in the finishes: AO - AA - AB (AT, CH and SB available on demand with a minimum quantity order of 100 pcs) and in the wooden finishes: 05W-08W-10W-29W-30W-31W-34W-37W-41W-42W.  
The code of the selected colour must be added to the article code. E.g.: PINT... 07 (chosen finish anod. gold) PINTAO 07.

**ANODIZED ALUM. (6 anod. alum. finishes of which 3 on demand)**  
thermo packed  
bar length 0,90 lm - 20 Pcs - BLISTER PACKS



Article	H mm
PINT... 07S	7 / 8
PINT... 09S	9 / 10
PINT... 11S	11 / 12
PINT... 15S	15 / 16

Available in the finishes: AO - AA - AB (AT, CH and SB available on demand with a minimum quantity order of 100 pcs) and in the wooden finishes: 05W-08W-10W-29W-30W-31W-34W-37W-41W-42W.  
The code of the selected colour must be added to the article code. E.g.: PINT... 07S (chosen finish anod. gold) PINTAO 07S.



**ALUMINIUM COVERED (80 wooden finishes of which 70 on demand)**  
thermo packed - bar length 2,7 lm - pack. 20 Pcs - 54 lm  
(H 11 - H 15 mm - 80 lm)

Article	H mm
PINT... 09	9
PINT... 11	11
PINT... 15	15

**ALUMINIUM COVERED (80 wooden finishes of which 70 on demand)**  
thermo packed  
bar length 0,90 lm - 20 Pcs - BLISTER PACKS



Article	H mm
PINT... 09S	9 / 10
PINT... 11S	11 / 12
PINT... 15S	15 / 16

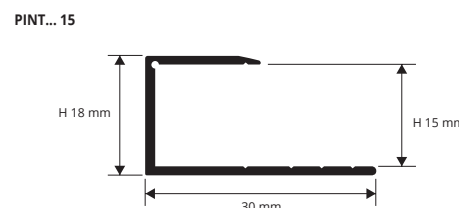
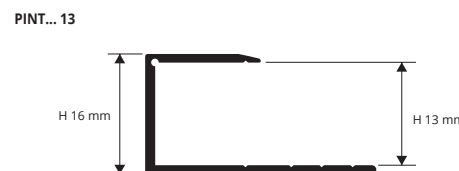
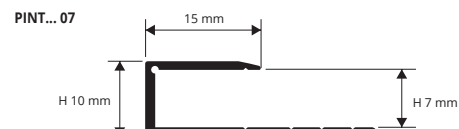

terminal - outer profiles

## EXAMPLES AND INSTRUCTIONS FOR LAYING METHODS

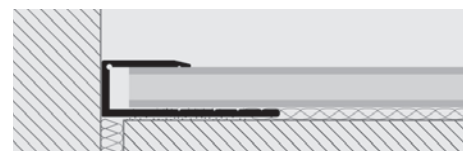

1. Choose the TERMINAL according to the required height and finish and fix with screws and screw anchors or with glue/silicone; the profile must be placed next to the abutting surface e.g. wall, glazing, etc. 2. Align the laminate/melamine/wood floor, ensuring that a large enough gap is left to accommodate the natural expansion between the floor and the profile (approx. 3/10mm on one side).

### ANODIZED COLOURS



### \* ANODIZED COLOURS ON DEMAND

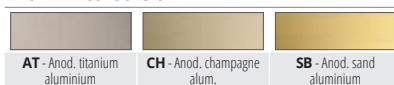

### WOODEN COLOURS



### \* WOODEN COLOURS ON DEMAND

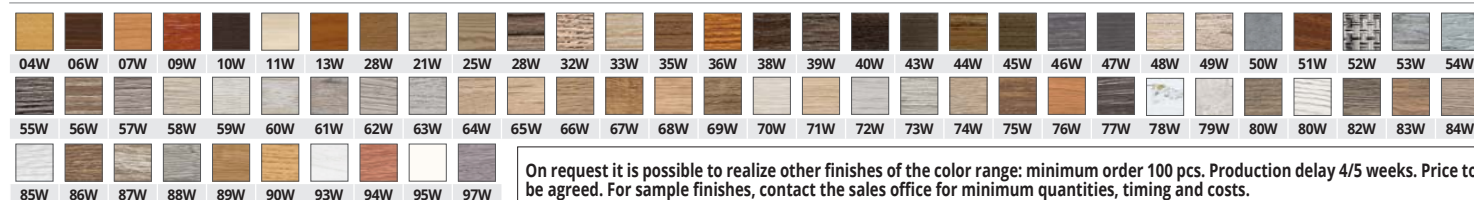

On request it is possible to realize other finishes of the color range: minimum order 100 pcs. Production delay 4/5 weeks. Price to be agreed. For sample finishes, contact the sales office for minimum quantities, timing and costs.

\* = Production on demand with minimum quantity of 100 pcs. Production delay 4/5 weeks. Price to be agreed



# STYLE STAIR

TOP IN WOODEN FINISHES  
and ANODIZED FINISHES  
+ PIN INSERT + ALUMINIUM BASE

The **STYLE STAIR** range comprises a large assortment of aluminium step nosing profiles for the edges of steps in wood, parquet, laminate or melamine with thickness varying from 7 to 20 mm. wooden finishes are available, plus anodized finishes. Select the most suitable profile for the thickness of the floor. There is a profile (top) and an insert (pin) for each height, while the base (punched or perforated) allows fixing by screwing or gluing.

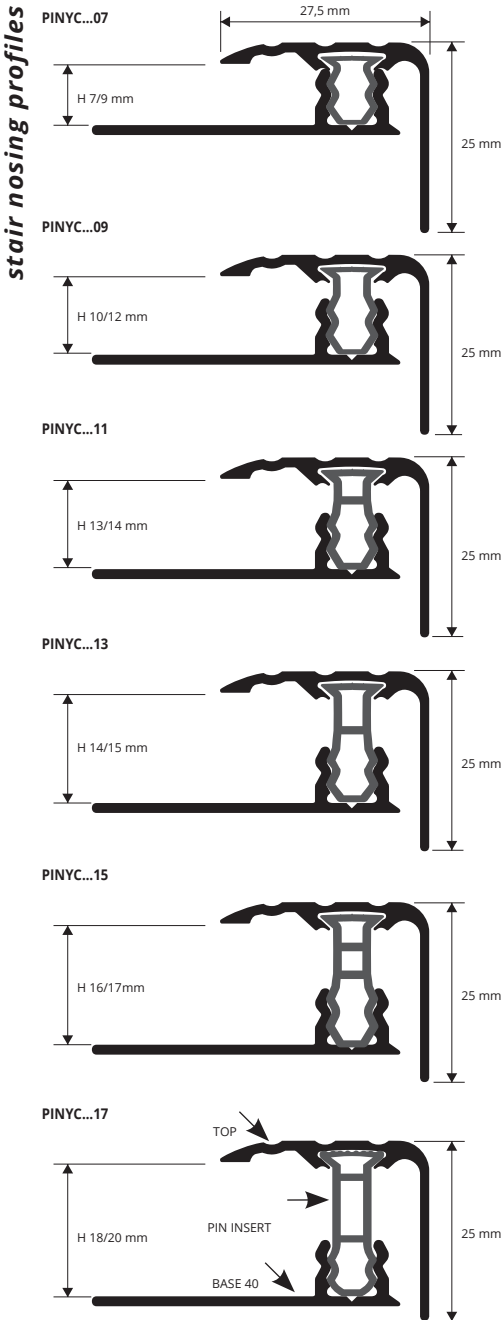

**ALUM. TOP + PIN INSERT + ALUM. BASE 40 PUNCHED/PERFORATED** (6 anod. alum. finishes of which 3 on demand) thermo packed bar length 2,7 lm - pack. 20 Pcs - 54 lm (H 14 - H 16 - H 18 mm - 40,5 lm)

Article	H mm
PINYC... 07 (PIN 07)	7 / 9
PINYC... 09 (PIN 09)	10 / 12
PINYC... 11 (PIN 11)	13 / 14
PINYC... 13 (PIN 13)	14 / 15
PINYC... 15 (PIN 15)	16 / 17
PINYC... 17 (PIN 17)	18 / 20

COMPLETE



**ALUM. TOP COVERED + PIN INSERT + ALUM. BASE 40 PUNCHED/PERFORATED** (80 wooden finishes of which 60 on demand) thermo packed bar length 2,7 lm - pack. 20 Pcs - 54 lm (H 14 - H 16 - H 18 mm - 40,5 lm)

Article	H mm
PINYC... 07 (PIN 07)	7 / 9
PINYC... 09 (PIN 09)	10 / 12
PINYC... 11 (PIN 11)	13 / 14
PINYC... 13 (PIN 13)	14 / 15
PINYC... 15 (PIN 15)	16 / 17
PINYC... 17 (PIN 17)	18 / 20

COMPLETE

Available in the finishes: AO - AA - AB (AT, CH and SB available on demand with a minimum quantity order of 200 pcs) and in the wooden finishes: 05W - 07W - 09W - 18W - 21W - 29W - 30W - 31W - 32W - 34W - 35W - 37W - 41W - 42W - 44W - 46W - 48W - 49W - 65W - 73W - 75W. The code of the selected colour must be added to the article code. E.g.: PINYC... 07 (chosen finish anod. gold) PINYCAO 07.

### EXAMPLES AND INSTRUCTIONS FOR LAYING METHODS

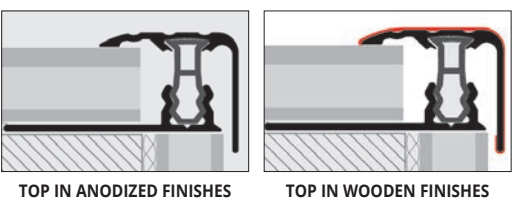

1. Fix the base exactly over the stair riser.
2. Align the laminate/melamine/wood floor, ensuring that approx. 3/10mm gap is left on one side to accommodate the natural expansion between the floor and the base.
3. Choose the desired profile, if necessary cut TOP, PIN and BASE at the needed length and then insert the PIN in the TOP in the specific "dovetail" seat. The position the profile above the U-shaped snap-in seat of the base.
4. With the aid of a board, hammer the TOP to the desired fitting level.

### ANODIZED COLOURS

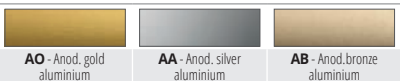

### \* ANODIZED COLOURS ON DEMAND



### WOODEN COLOURS



### \* WOODEN COLOURS ON DEMAND

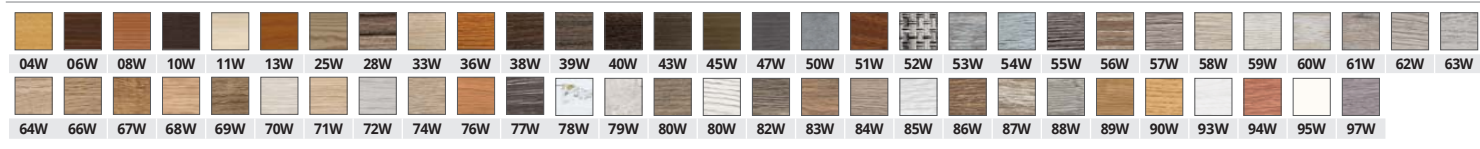

On request it is possible to realize other finishes of the color range: minimum order 200 pcs. Production delay 4/5 weeks. Price to be agreed. For sample finishes, contact the sales office for minimum quantities, timing and costs.

\* = Article on demand minimum order 200 pcs. Production delay 4/5 weeks. Price to be agreed.

**STYLE STAIR L** comprises a large range of aluminium stair nosing protecting profiles for step in timber, parquet, laminate or melamine material with thickness varying from 7 to 20 mm. wooden finishes are available, plus anodized finishes. The profiles is made with 3 pcs. A natural aluminium base to scrow or glue to the pavement, a PIN in non-toxic rigid to insert in the TOP, then a TOP should be selected most suitable for the floor.

# STYLE STAIR L

TOP IN WOODEN FINISHES  
AND ANODIZED FINISHES  
+ PIN INSERT + ALUMINIUM BASE



**ALUM. TOP + PIN INSERT + ALUM. BASE 40 PUNCHED/PERFORATED (6 anod. alum. finishes of which 3 on demand) thermo packed bar length 2,7 lm - pack. 20 Pcs - 54 lm (H 14 - H 16 - H 18 mm - 40,5 lm)**

Article	H mm
PINYLC... 07 (PIN 07)	7 / 9
PINYLC... 09 (PIN 09)	10 / 12
PINYLC... 11 (PIN 11)	13 / 14
PINYLC... 13 (PIN 13)	14 / 15
PINYLC... 15 (PIN 15)	16 / 17
PINYLC... 17 (PIN 17)	18 / 20

### COMPLETE

Available in the finishes: AO - AA - AB (AT, CH and SB available on demand with a minimum quantity order of 200 pcs) and in the wooden finishes: 04W - 05W - 13W - 18W - 21W - 25W - 29W - 30W - 31W - 32W - 33W - 34W - 35W - 36W - 37W - 38W - 39W - 41W - 42W - 44W - 45W - 58W - 54W - 55W.

The code of the selected colour must be added to the article code. E.g.: PINYLC... 07 (chosen finish anod. gold) PINYLCAO 07.

### EXAMPLES AND INSTRUCTIONS FOR LAYING METHODS

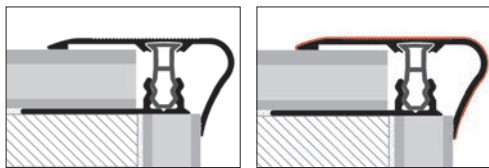

TOP IN ANODIZED FINISHES

TOP IN WOODEN FINISHES

1. Fix the base exactly over the stair riser. 2. Align the laminate/melamine/wood floor, ensuring that approx. 3/10mm gap is left on one side to accommodate the natural expansion between the floor and the base. 3. Choose the desired profile, if necessary cut TOP, PIN and BASE at the needed length and then insert the PIN in the TOP in the specific "dovetail" seat. The position the profile above the U-shaped snap-in seat of the base. 4. With the aid of a board, hammer the TOP to the desired fitting level.

### ANODIZED COLOURS

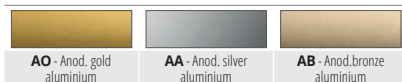

### \* ANODIZED COLOURS ON DEMAND

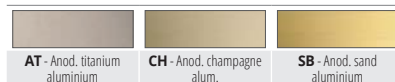

### WOODEN COLOURS



### \* WOODEN COLOURS ON DEMAND



On request it is possible to realize other finishes of the color range: minimum order 200 pcs. Production delay 4/5 weeks. Price to be agreed. For sample finishes, contact the sales office for minimum quantities, timing and costs.

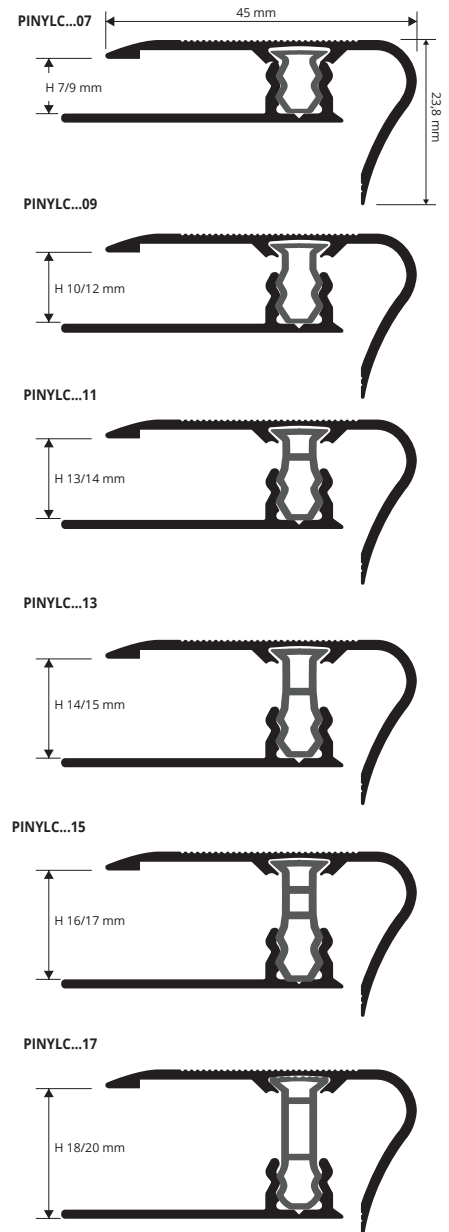

transition profiles

\* = Production on demand with minimum quantity of 200 pcs. Production delay 4/5 weeks. Price to be agreed



## UNIVERSAL, CONNECTION AND PERIMETER JOINTS



**SOL 30P** (Page 244)



**ZERO CURVE** (Page 244)



**TERMINAL PIN** (Page 244)

## CONNECTION JOINTS



**PROINTER KL  
ACC / ALL** (Page 30-32)



**PROSHELL D  
ALL** (Page 159)



**PROSHELL R  
ALL** (Page 159)



**PROLEVALL 305**  
(Page 80)



**PROLINOLEUM**  
(Page 85)



**PROFLOOR 24**  
(Page 85)



**PROSLIDER KL  
ALL** (Page 86)



**PROCOVER  
1045 ALL** (Page 86)

## STAIR NOSINGS PROFILES



**PROSTYLE KL 10** (Page 161)



**PROSTAIR KL 20** (Page 161)

# LVT PROFILES - SOL 30P

AWOODEN FINISHES and ANODIZED FINISHES

**SOL 30P, ZERO CURVE AND TERMINAL PIN** are profile which serve as expansion joints, junction and as perimetrical expansion joint between different floors in vinyl. The profiles are composed of a **BASE** in PVC to fix to the support and of three **TOP**. The choice of the **TOP** depend on the desired application. Their particular section, together with the wide range of finishes available and the ease of installation, make them a much-sought profiles, that could be easily matched with every type of floor in vinyl.

universal joints

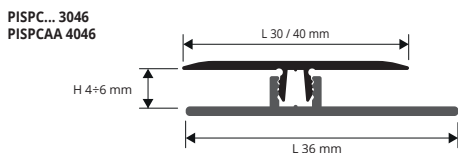

EXAMPLES OF LAYING

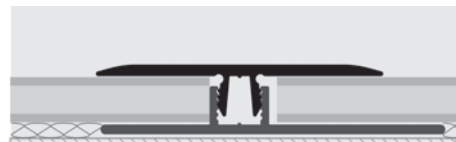

### INSTRUCTIONS FOR LAYING METHODS

1. Choose SOL P / ZERO CURVE / TERMINAL PIN according to the desired finish. 2. Cut the **BASE** in vinyl resin/PVC to the desired length and fix it with adhesive or dowels to the support. 3. Lay the floor in vinyl, leaving a 5 mm joint between the vertical walls of the base in vinyl resin/PVC and the floor. 4. Cut the desired **TOP** in aluminium to the desired length. 5. Place a small wooden board on the **TOP** in aluminium and hammer equally in order to facilitate the insertion of the **TOP** into the pvc base.



**ALUMINIUM TOP 6** anod. finishes (3 on demand) + **BASE** (vinyl resin/PVC) -thermo packed - bar length **2,7 lm** - pack. **20 Pcs - 54 lm**

Article	L mm
PISPC... 3046	30

The code of the selected colour must be added to the article code. E.g.: PISPC... 3046 (chosen finish anod. gold) PISPCAO 3046.

**ALUMINIUM TOP 80** wooden finishes (56 on demand) + **BASE** (vinyl resin/PVC) - thermo packed - bar length **2,7 lm** - pack. **20 Pcs - 54 lm**

Article	L mm
PISPC... 3046	30

The code of the selected colour must be added to the article code. E.g.: PISPC... 3046 (chosen finish anod. gold) PISPCAO 3046.

**ALUMINIUM TOP** (anod. silver) + **BASE** (vinyl resin/PVC) thermo packed - bar length **2,7 lm** - pack. **20 Pcs - 54 lm**

Article	L mm
PISPCAA 4046	40

# LVT PROFILES - ZERO CURVE

WOODEN FINISHES and ANODIZED FINISHES

transition profiles

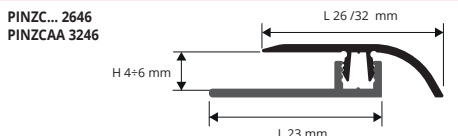

EXAMPLES OF LAYING



**ALUMINIUM TOP** (anod. silver) + **BASE** (vinyl resin/PVC) thermo packed - bar length **2,7 lm** - pack. **20 Pcs - 54 lm**

Article	L mm
PINZCAA 3246	32

**ALUMINIUM TOP 6** anod. finishes (3 on demand) + **BASE** (vinyl resin/PVC) -thermo packed - bar length **2,7 lm** - pack. **20 Pcs - 54 lm**

Article	L mm
PINZC... 2646	26

The code of the selected colour must be added to the article code. E.g.: PINZC... 2646 (chosen finish anod. gold) PINZCAO 2646.

**ALUMINIUM TOP 80** wooden finishes (56 on demand) + **BASE** (vinyl resin/PVC) - thermo packed - bar length **2,7 lm** - pack. **20 Pcs - 54 lm**

Article	L mm
PINZC... 2646	26

The code of the selected colour must be added to the article code. E.g.: PINZC... 2646 (chosen finish anod. gold) PINZCAO 2646.

# LVT PROFILES - TERMINAL PIN

WOODEN FINISHES and ANODIZED FINISHES

terminal

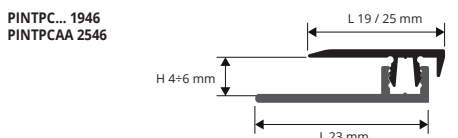

EXAMPLES OF LAYING

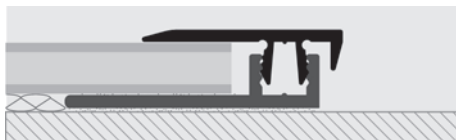

**ALUMINIUM TOP** (anod. silver) + **BASE** (vinyl resin/PVC) thermo packed - bar length **2,7 lm** - pack. **20 Pcs - 54 lm**

Article	L mm
PINTPCAA 2546	25

**ALUMINIUM TOP 6** anod. finishes (3 on demand) + **BASE** (vinyl resin/PVC) -thermo packed - bar length **2,7 lm** - pack. **20 Pcs - 54 lm**

Article	L mm
PINTPC... 1946	19

The code of the selected colour must be added to the article code. E.g.: PINTPC... 1946 (chosen finish anod. gold) PINTPCAO 1946.

**ALUMINIUM TOP 80** wooden finishes (56 on demand) + **BASE** (vinyl resin/PVC) - thermo packed - bar length **2,7 lm** - pack. **20 Pcs - 54 lm**

Article	L mm
PINTPC... 1946	19

The code of the selected colour must be added to the article code. E.g.: PINTPC... 1946 (chosen finish anod. gold) PINTPCAO 1946.

## COLOURS

(For a precise assessment of colours request the wooden finishes sample range)

ANODIZED					
ON DEMAND - MINIMUM QUANTITY 200 PCS					
AO - Anod. gold aluminium	AA - Anod. silver aluminium	AB - Anod. bronze aluminium	AT - Anod. titanium aluminium	CH - Anod. champagne alum.	SB - Anod. sand aluminium
05W - Light oak (strip)	09W - Red walnut (merbau-apple-walnut)	13W - Indonesian teak	18W - Light zerbano	21W - Oak powder	25W - Bleached fir
29W - White oak	30W - Grey oak	31W - Victoria oak			
33W - Sawed oak	34W - Havana oak	36W - American oak	37W - Carvi oak	38W - Queens oak	39W - Grey elm
41W - Ice oak	42W - Grace oak	43W - Manhattan oak			
44W - Honey oak	45W - Marocco oak	46W - Black decape	47W - Black oak	48W - Cork oak	49W - Sand oak
93W - New white					

On request it is possible to realize other finishes of the color range: minimum order 200 pcs. Production delay 4/5 weeks. Price to be agreed. For sample finishes, contact the sales office for minimum quantities, timing and costs.

**PROWALK 2510 & 2520** are new stair-nosing profiles for existing stairways. Designed to protect and restore stair steps made of wood, laminate, ceramic, etc. Made with anodized aluminium and wooden finishes. Available in self-adhesive or perforated versions. Sizes available: 2.7 m lengths and 0.9 m & 1.35 m Self-Pack.

# PROWALK 2510 & 2520

ANODIZED ALUMINIUM AND WOODEN FINISHES  
PUNCHED OR SELF ADHESIVE

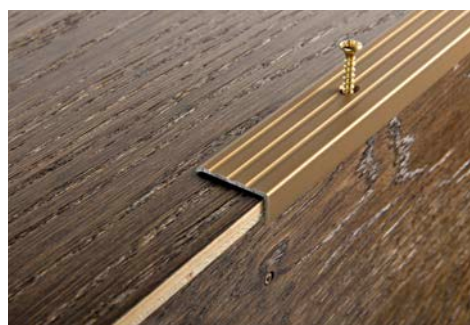

**ANODIZED ALUMINIUM with adhesive thermo packed**  
bar length 2,7 lm - pack. 40 Pcs - 108 lm

Article	L x H mm		
PWK... 2510A	24 x 10		
PWK... 2520A	24 x 20		

**ANODIZED ALUMINIUM with adhesive thermo packed** - bar length 0,90 lm - pack. 20 Pcs



Article	L x H mm		
PWK... 25109AS	24 x 10		
PWK... 25209AS	24 x 20		

**ANODIZED ALUMINIUM punched thermo packed**  
bar length 2,7 lm - pack. 40 Pcs - 108 lm

Article	L x H mm		
PWK... 2510F	24 x 10		
PWK... 2520F	24 x 20		

**ANOD. ALUM. PUNCHED with screws and screw anchors thermo packed** - bar length 0,90 lm - pack. 20 Pcs



Article	L x H mm		
PWK... 25109FS	24 x 10		
PWK... 25209FS	24 x 20		

**ANOD. ALUM. PUNCHED with screws and screw anchors thermo packed** - bar length 1,35 lm - pack. 20 Pcs



Article	L x H mm		
PWK... 251013FS	24 x 10		

Available in the colours: AO - AA - AB (AT, CH and SB available on demand) with a minimum quantity order of 200 pcs.  
The code of the selected colour must be added to the article code. E.g.: PWK... 2510A (chosen finish anod. silver) PWKAA 2510A.

**ALUMINIUM WOOD FINISH with adhesive thermo packed** - bar length 2,7 lm - pack. 40 Pcs - 108 lm

Article	L x H mm		
PWK... 2510A	24 x 10		
PWK... 2520A	24 x 20		

Available on demand in the colours: 04W - 05W - 07W - 09W - 13W - 18W - 21W - 25W - 29W - 30W - 31W - 32W - 33W - 34W - 35W - 36W - 37W - 38W - 39W - 41W - 42W - 44W - 45W - 46W - 48W - 49W - 53W - 54W - 55W - 65W - 73W - 75W with a minimum quantity order of x pcs.  
The code of the selected colour must be added to the article code. E.g.: PWK... 2510A (chosen finish dark beech) PWK04 2510A.

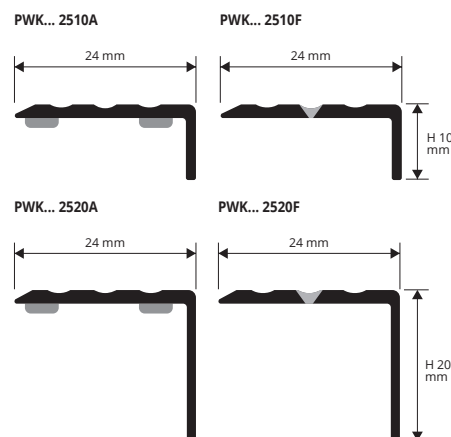

stair nosing profiles

EXAMPLES OF LAYING

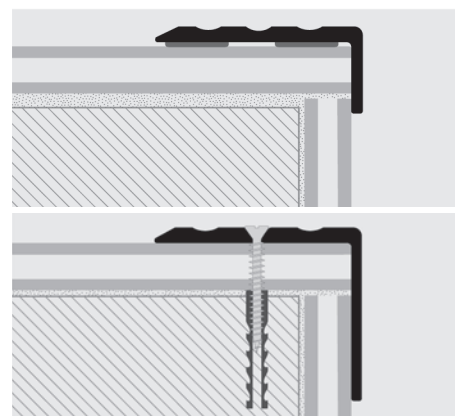

**PROSTEP INS** is a step cover profile in silver anodized aluminium ideal for protecting and laying laminated wood / floating melaminic and parquets. Available in two heights 10.5 and 16.

# PROSTEP INS

ANODIZED SILVER ALUMINIUM

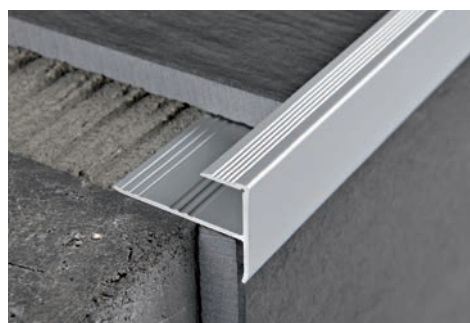

**ANODIZED SILVER ALUMINIUM thermo packed**  
bar length 2,7 lm - pack. 40 Pcs - 108 lm

Article	H mm		
PTSAA 105	10,2		
PTSAA 16	15,9		

COLOURS

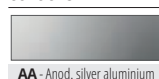

EXAMPLES OF LAYING

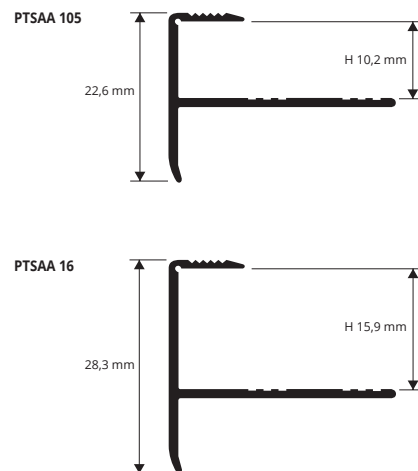

stair nosing profiles

\* = Production on demand with minimum quantity of 200 pcs. Production delay 4/5 weeks. Price to be agreed.

# SOL 30 SELF-ADHESIVE

ALUMINIUM COVERED WITH PROTECTIVE FILM IN WOODEN FINISHES

SOL 30 self-adhesive is a joint/threshold cover profile in aluminum covered with film wooden finishes, which is highly resistant to pedestrian traffic, wear, UV rays and commonly used floor cleaning products. Easy to lay and to match with any wood finish; the surface has an open pore embossed finish. Recommended for covering joints between floors in laminate, wood, ceramic tiles, etc.

threshold - joint-cover profiles

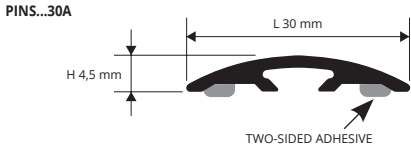

## EXAMPLES AND INSTRUCTIONS FOR LAYING METHODS

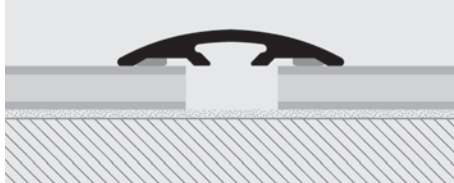

1. Choose the adhesive "SOL 30" in the required finish. 2. Cut the profile to the required length and clean, degrease and dry the surface, checking that the temperature for application is at least 15°. 3. Remove the protective paper from the adhesive and lay the profile correctly applying a uniform vertical pressure by hand without moving the profile and without using iron/steel hammers.



ALUMINIUM COVERED 80 wooden finishes (71 on demand) with ADHESIVE thermo packed - length 30 mm - bar length 2,7 lm - pack. 40 Pcs - 108 lm

Article	L mm
PINS...30A	30

Available in the wooden finishes: 04W - 05W - 07W - 08W - 09W - 10W - 11W - 28W - 29W - 30W.

The code of the selected colour must be added to the article code. E.g.: PINS... 30A (chosen finish dark beech) PINS04W 30A.



ALUMINIUM COVERED 80 wooden finishes (71 on demand) with ADHESIVE - thermo packed - bar length 0,90 lm - 20 Pcs

Article	L mm
PINS...309AS	30

# ZERO CURVE SELF-ADHESIVE

ALUMINIUM COVERED WITH WOODEN FINISHES AND ANODIZED ALUMINIUM

ZERO CURVE self-adhesive is a transition profile in anodised aluminum and aluminum covered with film in wooden finishes, which is highly resistant to pedestrian traffic, wear, UV rays and commonly used floor cleaning products. Easy to lay and to match with any wood finish; the surface has an open pore embossed finish. Recommended for covering joints between floors in laminate, wood, ceramic tiles, etc.

transition profiles

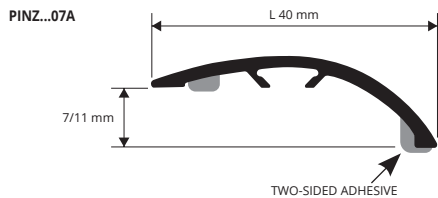

## EXAMPLES AND INSTRUCTIONS FOR LAYING METHODS

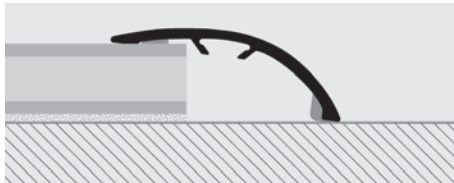

1. Choose the "ZERO CURVE" with adhesive with the required finish. 2. Cut the profile to the required length and clean, degrease and dry the surface, checking that the temperature for application is at least 15°. 3. Remove the protective paper from the adhesive and lay the profile correctly applying a uniform vertical pressure by hand without moving the profile and without using an iron/steel hammer.



ALUMINIUM COVERED 80 wooden finishes (49 on demand) with ADHESIVE thermo packed - length 40 mm - bar length 2,7 lm - pack. 40 Pcs - 108 lm

Article	L mm
PINZ...07A	40
PINZAA 07A	40

Available in the finish: AA - 04W - 05W - 07W - 09W - 13W - 18W - 21W - 25W - 29W - 30W - 31W - 32W - 33W - 34W - 35W - 36W - 37W - 38W - 39W - 41W - 42W - 44W - 45W - 46W - 48W - 49W - 53W - 54W - 55W - 65W - 73W - 75W.

The code of the selected colour must be added to the article code. E.g.: PINZ... 07A (chosen finish dark beech) PINZ04W 07A.



ALUMINIUM COVERED 80 wooden finishes (49 on demand) with ADHESIVE thermo packed - bar length 0,90 lm - 20 Pcs

Article	L mm
PINZ...079AS	40

## COLOURS

(For a precise assessment of colours request the wooden finishes sample range)

ANODIZED								
AA - Anod. silver aluminium								
04W - Dark beech	05W - Light oak (strip)	07W - Light cherry (strip)	09W - Red walnut (merbau-apple-walnut)	13W - Indonesian teak	18W - Light zerbano	21W - Oak powder	25W - Bleached fir	29W - White oak
30W - Grey oak	31W - Victoria oak	32W - Pink oak	33W - Sawed oak	34W - Havana oak	35W - Edinburgh oak	36W - American oak	37W - Carvi oak	38W - Queens oak
39W - Grey elm	41W - Ice oak	42W - Grace oak	44W - Honey oak	45W - Marocco oak	46W - Black decape'	48W - Cork oak	49W - Sand oak	53W
54W	55W	65W - Tripoli	73W - Bangkok	75W - Liotard				

On request it is possible to realize other finishes of the color range: minimum order 200 pcs. Production delay 4/5 weeks. Price to be agreed. For sample finishes, contact the sales office for minimum quantities, timing and costs.



**SOL 40P** self-adhesive is a joint/threshold cover profile in aluminum covered with film in wooden finishes, which is highly resistant to pedestrian traffic, wear, UV rays and commonly used floor cleaning products. Easy to lay and to match with any wood finish; the surface has an open pore embossed finish. Recommended for covering joints between floors in laminate, wood, ceramic tiles, etc.



**SILVER ANODIZED ALUMINIUM with ADHESIVE** thermo packed - bar length 90 cm - pack. 20 Pcs

Article	L mm
PNSPAA 409 PAS	40

**ALUMINIUM COVERED 80 wooden finishes (49 on demand) with ADHESIVE** - thermo packed - bar length 0,90 lm - 20 Pcs

Article	L mm
PNSP.. 409 PAS	40

**ALUMINIUM COVERED 80 wooden finishes (49 on demand) with ADHESIVE** - thermo packed - bar length 1 lm - 20 Pcs

Article	L mm
PNSPAA 4010 PAS	40

**SILVER ANODIZED ALUMINIUM with ADHESIVE** - thermo packed - bar length 1 lm - 20 Pcs

Article	L mm
PNSP.. 4010 PAS	40

**SILVER ANODIZED ALUMINIUM with ADHESIVE** thermo packed - length 40 mm - bar length 2,7 lm - pack. 40 Pcs - 108 lm

Article	L mm
PNSPAA 40 PA	40

**ALUMINIUM COVERED 80 wooden finishes (49 on demand) with ADHESIVE** thermo packed - length 40 mm - bar length 2,7 lm - pack. 40 Pcs - 108 lm

Article	L mm
PNSP.. 40 PA	40

Available in the colours: 04W - 05W - 07W - 09W - 13W - 18W - 21W - 25W - 29W - 30W - 31W - 32W - 33W - 34W - 35W - 36W - 37W - 38W - 39W - 41W - 42W - 44W - 45W - 46W - 48W - 49W - 53W - 54W - 55W - 65W - 73W - 75W.  
The code of the selected colour must be added to the article code. E.g.: PNSP... 40 PA (chosen finish dark beech) PNSP04W 40 PA.

## SOL 40P SELF-ADHESIVE

ALUMINIUM COVERED WOODEN FINISHES

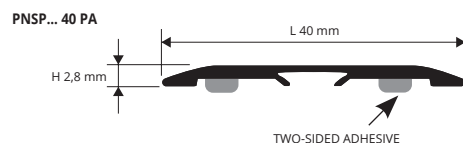

EXAMPLES AND INSTRUCTIONS FOR LAYING METHODS

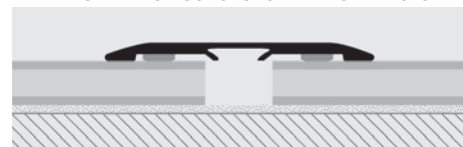

1. Choose the adhesive "SOL 40" in the required finish. 2. Cut the profile to the required length and clean, degrease and dry the surface, checking that the temperature for application is at least 15°. 3. Remove the protective paper from the adhesive and lay the profile correctly applying a uniform vertical pressure by hand without moving the profile and without using iron/steel hammers.

threshold - joint-cover profiles

**PROCOVER WOOD** is a joint-cover profile in aluminum covered with a very strong film available in wooden finishes. It is applied at the end of laying two adjoining floors with the same height, having left a 6 - 24 mm gap between the two floors set in a thin bed of adhesive. It protects the outside edges of the floor/covering. It is easy to lay and attractive. The design of the profile with lower vertical arrowhead part allows excellent anchorage with the silicone/adhesive.



**ALUMINIUM COVERED 80 wooden finishes (76 on demand) thermo packed** - bar length 2,7 lm - pack. 40 Pcs - 108 lm

Article	L x H mm
PCRA... 149	14 x 9
PCRA... 269	26 x 9

Available in the wooden finishes: 05W - 11W - 28W - 29W - 30W.  
The code of the selected colour must be added to the article code. Es.: PCRA.. 149 (chosen finish light oak) PCRA04W 149.

## PROCOVER WOOD

ALUMINIUM COVERED WITH PROTECTIVE FILM IN WOODEN FINISHES

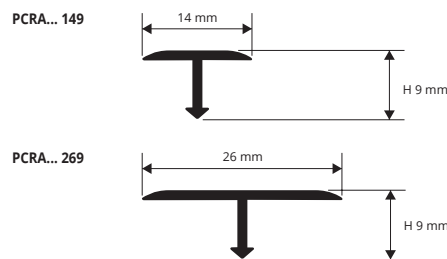

EXAMPLES AND INSTRUCTIONS FOR LAYING METHODS

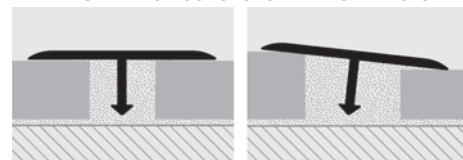

1. Choose the "PROCOVER" with the width suitable for the gap between the two floors to be joined, taking into consideration 2/3 mm - 2/32" - 1/8" side lap. 2. Fill the gap with single-pack silicone or with the adhesive used for laying the floor. 3. Bury the profile into the adhesive, making sure that both side laps of the profile rest on the coverings to be joined.

threshold - joint-cover profiles

### COLOURS



On request it is possible to realize other finishes of the color range: minimum order 200 pcs. Production delay 4/5 weeks. Price to be agreed. For sample finishes, contact the sales office for minimum quantities, timing and costs.

## PROCOVER INSERT

VINYL RESIN / BLACK RUBBER

Vinyl resin/rubber profile "U-form" for inserting PROCOVER with PINBFT 45 or PINBFT 40 Proinsert System base.

VINYL RESIN / RUBBER

length 2,7 lm and/or in rolls

Article
PCPCR

**PROINSERT BASE 45 and BASE 40 - ALUM. PUNCHED/PERFORED** bar length 2,7 lm - pack. 20 Pcs - 54 lm

Article	H mm
PINBFT 45	45
PINBFT 40	40

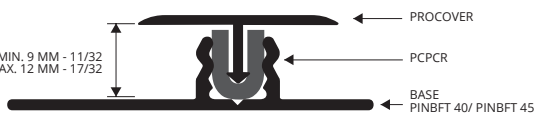

PCRA... 149/1499/209/269 + INS + BASE 45/40

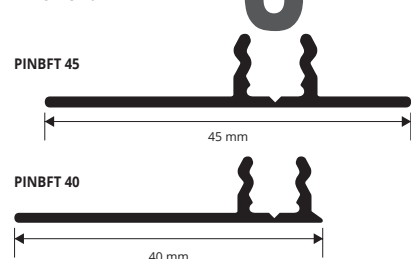

# PROFIXER LINE SYSTEM

ZERO CURVE INSERTS + NYLON ANCHORS + BASE  
WOODEN FINISHES AND ANODIZED FINISHES

The **PROFIXER LINE SYSTEM** comprises an assortment of profiles in aluminium with a longitudinal dovetail groove/channel into which the anchors or the tap-down punched/perforated aluminium profile may be inserted for easy and invisible fixing.  
The profiles are covered with wooden finishes that are highly resistant to pedestrian traffic, wear, UV rays and commonly used floor cleaning products. Plus anodized finishes. The **PROFIXER LINE SYSTEM** profiles are recommended for floors up to 22.5 mm thick.

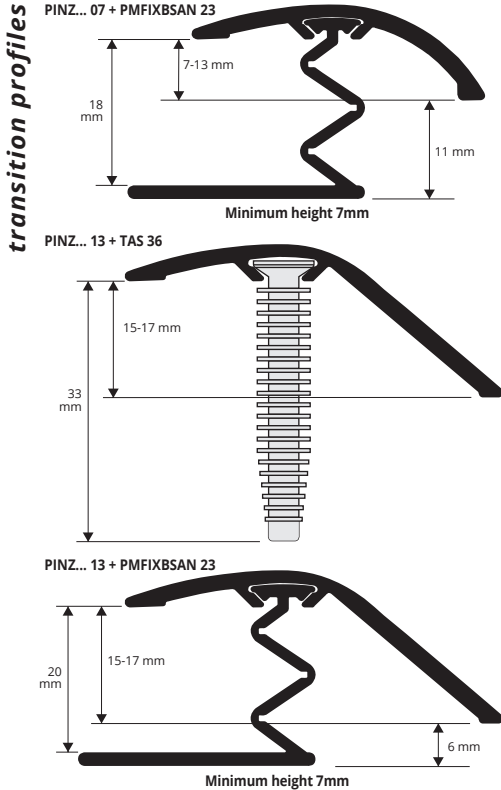

**ANODIZED ALUMINIUM (6 anod. alum. finishes of which 3 on demand)**  
thermo packed - bar length 2,7 lm - pack 20 Pcs - 54 lm

Article	L mm	H mm
PINZ... 07	40	7 - 13
PINZ... 13	47	15 - 17

Available in the finishes: AO - AA - AB (AT, CH and SB available on demand with a minimum quantity order of 100 pcs) and in the wooden finishes: 04W - 05W - 07W - 09W - 13W - 18W - 21W - 25W - 29W - 30W - 31W - 32W - 33W - 34W - 35W - 36W - 37W - 38W - 39W - 41W - 42W - 44W - 45W - 46W - 48W - 49W - 53W - 54W - 55W - 65W - 73W - 75W.

The code of the selected colour must be added to the article code. E.g.: PINZ... 07 (chosen finish anod. gold) PINZAO 07.

**ALUMINIUM COVERED (80 wooden finishes of which 49 on demand)**  
thermo packed - bar length 2,7 lm - pack 20 Pcs - 54 lm

Article	L mm	H mm
PINZ... 07	40	7 - 13
PINZ... 13	47	15 - 17

**ANODIZED ALUMINIUM (6 anod. alum. finishes of which 3 on demand)**  
thermo packed - bar length 0,90 lm - 20 Pcs  
with 5 anchors

Article	L mm	H mm
PINZ... 07S	40	7 - 13
PINZ... 13S	47	15 - 17

Available in the finishes: AO - AA - AB (AT, CH and SB available on demand with a minimum quantity order of 100 pcs) and in the wooden finishes: 04W - 05W - 07W - 09W - 13W - 18W - 21W - 25W - 29W - 30W - 31W - 32W - 33W - 34W - 35W - 36W - 37W - 38W - 39W - 41W - 42W - 44W - 45W - 46W - 48W - 49W - 53W - 54W - 55W - 65W - 73W - 75W.

The code of the selected colour must be added to the article code. E.g.: PINZ... 07 (chosen finish anod. gold) PINZAO 07.

**ALUMINIUM COVERED (80 wooden finishes of which 49 on demand)**  
thermo packed - bar length 0,90 lm - 20 Pcs  
with 5 anchors

Article	L mm	H mm
PINZ... 07S	40	7 - 13
PINZ... 13S	47	15 - 17

## EXAMPLES AND INSTRUCTIONS FOR LAYING METHODS

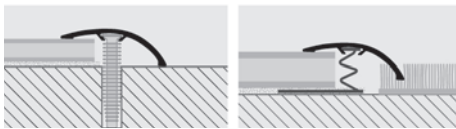

## COLOURS

(For a precise assessment of colours request the wooden finishes sample range)

ANODIZED								
AO - Anod. gold aluminium	AA - Anod. silver aluminium	AB - Anod. bronze aluminium	AT - Anod. titanium aluminium	CH - Anod. champagne alum.	SB - Anod. sand aluminium			
<b>ON DEMAND - MINIMUM QUANTITY 200 PCS</b>								
04W - Dark beech	05W - Light oak (strip)	07W - Light cherry (strip)	09W - Red walnut (merbau-apple-walnut)	13W - Indonesian teak	18W - Light zerbano	21W - Oak powder	25W - Bleached fir	29W - White oak
30W - Grey oak	31W - Victoria oak	32W - Pink oak	33W - Sawed oak	34W - Havana oak	35W - Edinburgh oak	36W - American oak	37W - Carvl oak	38W - Queens oak
39W - Grey elm	41W - Ice oak	42W - Grace oak	44W - Honey oak	45W - Marocco oak	46W - Black decapè'	48W - Cork oak	49W - Sand oak	53W
54W	55W	65W - Tripoli	73W - Bangkok	75W - Liotard				

On request it is possible to realize other finishes of the color range: minimum order 200 pcs. Production delay 4/5 weeks. Price to be agreed. For sample finishes, contact the sales office for minimum quantities, timing and costs.

# NYLON 36 SCREW ANCHORS AND TAP-DOWN BASE

**SCREW ANCHORS 36 - H 36 mm - pack 20 Pcs**  
for SOL 30-40-50 and ZERO CURVE 07-15

Article	H mm
TAS 36	36

minimum order 5 pcs.

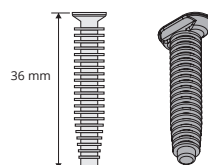

**PROFIXER TAP-DOWN BASE - ALUM. PUNCHED/PERFORED**  
for SOL 30-40-50 and ZERO CURVE 07-15  
bar length 2,7 lm - pack 20 Pcs - 54 lm

Article	H mm
PMFIXBSAN 23	23

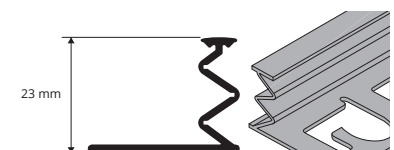



The **PROFIXER LINE SYSTEM** comprises an assortment of profiles in aluminium with a longitudinal dovetail groove/channel into which the anchors or the tap-down punched/perforated aluminium profile may be inserted for easy and invisible fixing.  
The profiles are covered with wooden finishes that are highly resistant to pedestrian traffic, wear, UV rays and commonly used floor cleaning products. Plus six anodized finishes (3 available on demand). The **PROFIXER LINE SYSTEM** profiles are recommended for floors up to 22.5 mm thick.

# PROFIXER LINE SYSTEM

INSERTS SOL 30 - SOL 40P - SOL 50  
+ NYLON ANCHORS + BASE

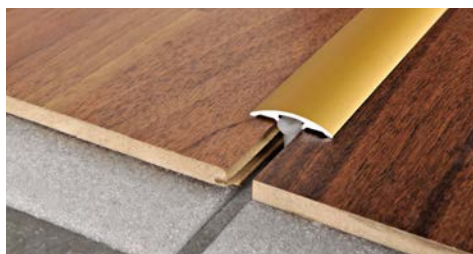

**ANODIZED ALUMINIUM** (6 anod. alum. finishes of which 3 on demand)  
thermo packed - bar length 2,7 lm - pack. 40 Pcs - 108 lm

Article	L mm		
PINS... 30	30		
PNSP... 40P	40		

**ANODIZED ALUM.** (6 anod. alum. finishes of which 3 on demand)  
thermo packed - bar length 0,90 lm - 20 Pcs with 5 anchors 

Article	L mm		
PINS... 309S	30		

Available in the colours: AO - AA - AB (AT, CH and SB on demand with a minimum quantity order of 200 pcs)

**ALUMINIUM COVERED** (80 wooden finishes of which 71 on demand)  
thermo packed - bar length 2,7 lm - pack. 40 Pcs - 108 lm

Article	L mm		
PINS... 30	30		

**ALUM. COVERED** (80 wooden finishes of which 71 on demand)  
thermo packed - bar length 0,90 lm - 20 Pcs with 5 anchors 

Article	L mm		
PINS... 309S	30		

Available in the wooden finishes: 04W - 05W - 07W - 08W - 09W - 10W - 11W - 28W - 29W - 30W.  
The code of the selected colour must be added to the article code.  
E.g.: PINS...30 (chosen finish dark beech) PINS04W 30.

**ALUMINIUM COVERED** (80 wooden finishes of which 49 on demand)  
thermo packed - bar length 2,7 lm - pack. 40 Pcs - 108 lm

Article	L mm		
PNSP... 40 P	40		

Available in the colours: 04W - 05W - 07W - 09W - 13W - 18W - 21W - 25W - 29W - 30W - 31W - 32W - 33W - 34W - 35W - 36W - 37W - 38W - 39W - 41W - 42W - 44W - 45W - 46W - 48W - 49W - 53W - 54W - 55W - 65W - 73W - 75W.  
The code of the selected colour must be added to the article code.  
E.g.: PINS... 30 (chosen finish anod. gold) PINSAO 30.

**ANODIZED SILVER ALUMINIUM**  
thermo packed - bar length 2,7 lm - pack. 20 Pcs - 54 lm

Article	L mm		
PINSAA 50	50		

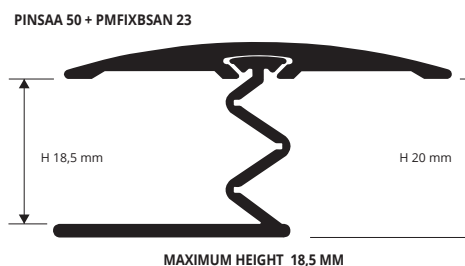
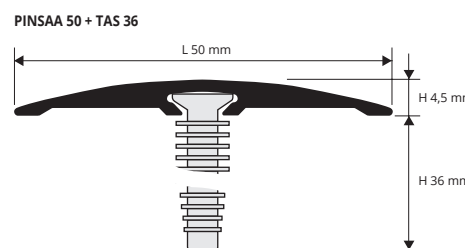
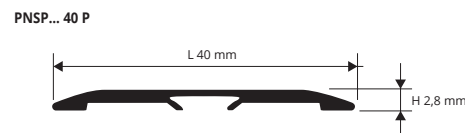
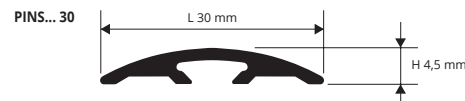

JOINTS

## NYLON 36 SCREW ANCHORS AND TAP-DOWN BASE

**SCREW ANCHORS 36 - H 36 mm - pack. 20 Pcs**  
for SOL 30-40-50 and ZERO CURVE 07-15

Article	H mm		
TAS 36	36		

minimum order 5 pcs.

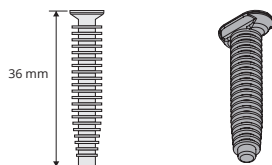

**PROFIXER TAP-DOWN BASE - ALUM. PUNCHED/PERFORATED**  
for SOL 30-40-50 and ZERO CURVE 07-15  
bar length 2,7 lm - pack. 20 Pcs - 54 lm

Article	H mm		
PMFIXBSAN 23	23		

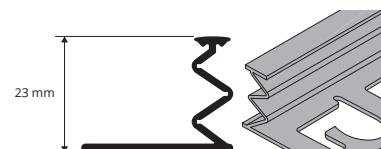

EXAMPLES AND INSTRUCTIONS FOR LAYING METHODS

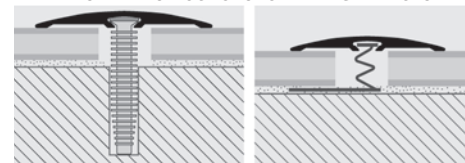

1. Choose the PROFIXER LINE SYSTEM profile in the required type and finish. 2. Cut the profile to the required length.

**For the version with screw anchors:**

3. Make 5 drill holes per linear metre on the floor using a Ø 7mm drill, insert the anchors into the relative groove/channel of the profile and with the help of a rubber/plastic hammer, tap evenly over the surface until the anchor slots into the hole.

**For the version with tap-down aluminium base:**

3. First insert the base into the groove/channel of the "TOP" profile and then fix or glue the base to the floor; alternatively first fix or glue the base to the floor and then insert the 'profile. 4. Close the profile, applying uniform pressure, either manually or with the help of a rubber hammer.

# PROSCREW 34

ANODIZED SILVER, GOLD, BRONZE, SAND AND CHAMPAGNE ALUMINIUM

universal joints with screw

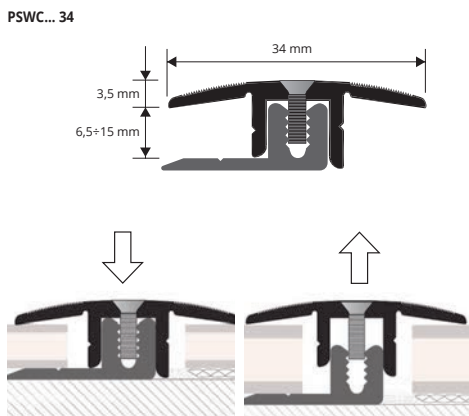

BASE + TOP IN ANODIZED SILVER, GOLD, BRONZE, SAND AND CHAMPAGNE ALUMINIUM + SCREWS AND SCREW ANCHORS thermo packed - bar length 2,7 lm - pack. 20 Pcs - 54 lm

Article	L mm
PSWCAA 34	34
PSWCAO 34	34
PSWCBS 34	34
PSWCAB 34	34
PSWCCH 34	34

To order the following items (top and base), see page 259

TOP IN ANODIZED SILVER, GOLD, BRONZE, SAND AND CHAMPAGNE ALUMINIUM thermo packed  
bar length 2,7 lm - pack. 20 Pcs - 54 lm

Article	L mm
PSWAA 34	34
PSWAO 34	34
PSWSB 34	34
PSWAB 34	34
PSWCH 34	34

BASE IN NATURAL ALUMINIUM thermo packed - bar length 2,7 lm - pack. 20 Pcs - 54 lm

Article	L mm
PSWBAN 07F	22,6

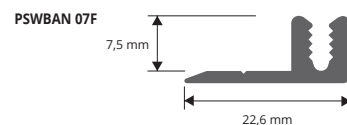

# PROSCREW 44

ANODIZED SILVER, GOLD, BRONZE, SAND AND CHAMPAGNE ALUMINIUM

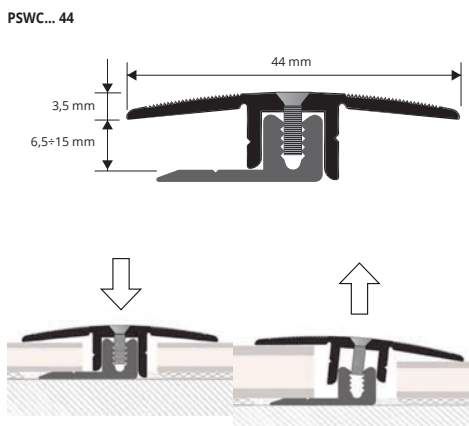

BASE + TOP IN ANODIZED SILVER, GOLD, BRONZE, SAND AND CHAMPAGNE ALUMINIUM + SCREWS AND SCREW ANCHORS thermo packed - bar length 2,7 lm - pack. 20 Pcs - 54 lm

Article	L mm
PSWCAA 44	44
PSWCAO 44	44
PSWCBS 44	44
PSWCAB 44	44
PSWCCH 44	44

To order the following items (top and base), see page 259

TOP IN ANODIZED SILVER, GOLD, BRONZE, SAND AND CHAMPAGNE ALUMINIUM thermo packed  
bar length 2,7 lm - pack. 20 Pcs - 54 lm

Article	L mm
PSWAA 44	44
PSWAO 44	44
PSWSB 44	44
PSWAB 44	44
PSWCH 44	44

BASE IN NATURAL ALUMINIUM thermo packed - bar length 2,7 lm - pack. 20 Pcs - 54 lm

Article	L mm
PSWBAN 07F	22,6

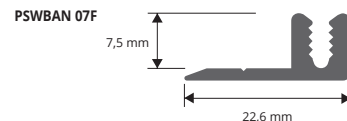

# PROSCREW 33

ANODIZED SILVER, GOLD, BRONZE, SAND AND CHAMPAGNE ALUMINIUM

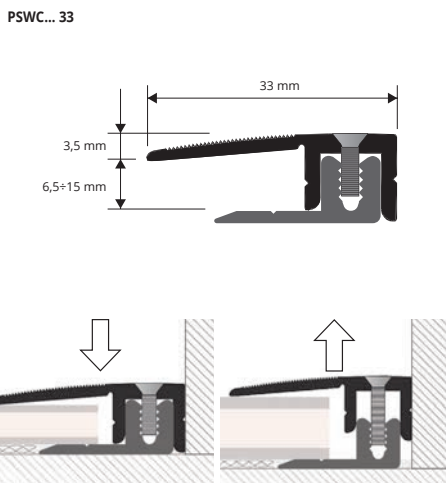

BASE + TOP IN ANODIZED SILVER, GOLD, BRONZE, SAND AND CHAMPAGNE ALUMINIUM + SCREWS AND SCREW ANCHORS thermo packed - bar length 2,7 lm - pack. 20 Pcs - 54 lm

Article	L mm
PSWCAA 33	33
PSWCAO 33	33
PSWCBS 33	33
PSWCAB 33	33
PSWCCH 33	33

To order the following items (top and base), see page 259

TOP IN ANODIZED SILVER, GOLD, BRONZE, SAND AND CHAMPAGNE ALUMINIUM thermo packed  
bar length 2,7 lm - pack. 20 Pcs - 54 lm

Article	L mm
PSWAA 33	33
PSWAO 33	33
PSWSB 33	33
PSWAB 33	33
PSWCH 33	33

BASE IN NATURAL ALUMINIUM thermo packed - bar length 2,7 lm - pack. 20 Pcs - 54 lm

Article	L mm
PSWBAN 07F	22,6

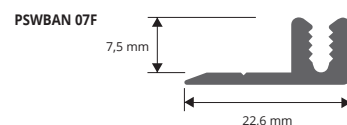

## COLOURS



## ON DEMAND (minimum quantity 100 pcs)



\* = Production on demand with minimum quantity of 200 pcs. Production delay 4/5 weeks. Price to be agreed.



**TOP IN ANODIZED SILVER, GOLD, BRONZE, SAND AND CHAMPAGNE ALUMINIUM thermo packed**  
bar length 2,7 lm - pack. 20 Pcs - 54 lm

Article	L mm
PSWAA 50	50
PSWAO 50	50
PSWSB 50	50
PSWAB 50	50
PSWCH 50	50

**BASE + TOP IN ANODIZED SILVER, GOLD, BRONZE, SAND AND CHAMPAGNE ALUMINIUM + SCREWS AND SCREW ANCHORS thermo packed** - bar length 2,7 lm - pack. 20 Pcs - 54 lm

Article	L mm
PSWCAA 50	50
PSWCAO 50	50
PSWCSB 50	50
PSWCAB 50	50
PSWCCH 50	50

**BASE IN NATURAL ALUMINIUM thermo packed** - bar length 2,7 lm - pack. 20 Pcs - 54 lm

Article	L mm
PSWBAN 07F	22,6

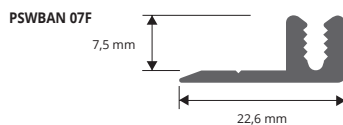

To order the following items (top and base), see page 259

**COLOURS**



**ON DEMAND (minimum quantity 100 pcs)**



**PROSCREW 50**

ANODIZED SILVER, GOLD, BRONZE, SAND AND CHAMPAGNE ALUMINIUM

PSWC... 50

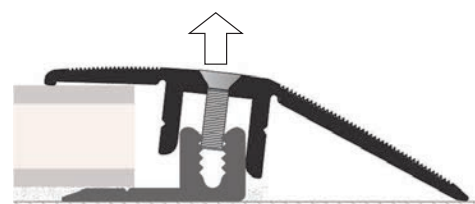
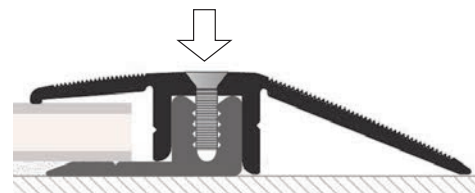
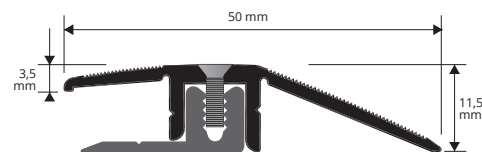

universal joints with screw

**SCREWS to fix all perforated versions**

NICKEL PLATED

**WHITE NICKEL-PLATED FLATHEAD SCREW UNI 7688 3X10**  
pack. 14 Pcs

Article	Ø mm	H mm
VIZBP 310	05	10

**WHITE NICKEL-PLATED FLATHEAD SCREW UNI 7688 3X16**  
pack. 14 Pcs

Article	Ø mm	H mm
VIZBP 316	05	16

VIZBP 310

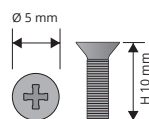

VIZBP 316

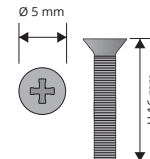

**KIT PROSCREW**

KIT PROSCREW

Article	
KIT PROSCREW	KIT consists of 14 screws VIZBP 310, 14 screws VIZBP 316, 15 screws + screw anchors VINPT 325

KIT PROSCREW

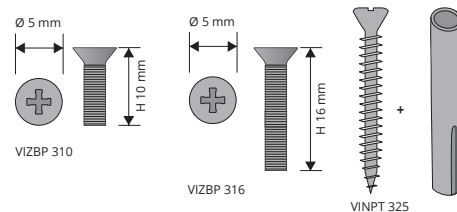

**EXAMPLES OF LAYING**

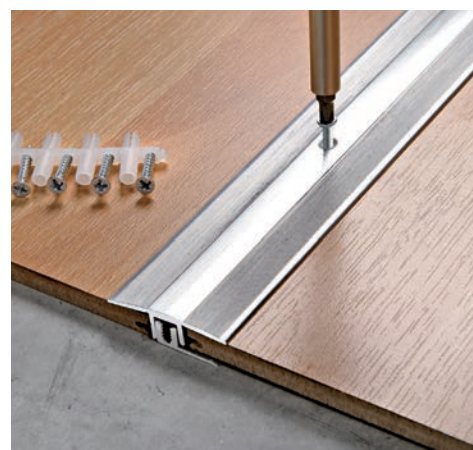

\* = Production on demand with minimum quantity of 200 pcs. Production delay 4/5 weeks. Price to be agreed.

# PROMULTISKIRT SQUARE

FOAMED VINYL RESIN

**PROMULTISKIRT SQUARE** is an expanded vinyl resin profile covered with a vinyl resin film available in white, black, silver and wood finishes. The profile has a good resistance to chemical agents and can be secured to the wall with plastic supports fixed with screws or silicone. The skirting height is 100 mm, it can be cut to 80 and 60 mm heights thanks to the pre-incisions on the back. PROMULTISKIRT SQUARE in expanded vinyl resin coated with vinyl resin film is suitable for any indoor environment.

**PATENTED**

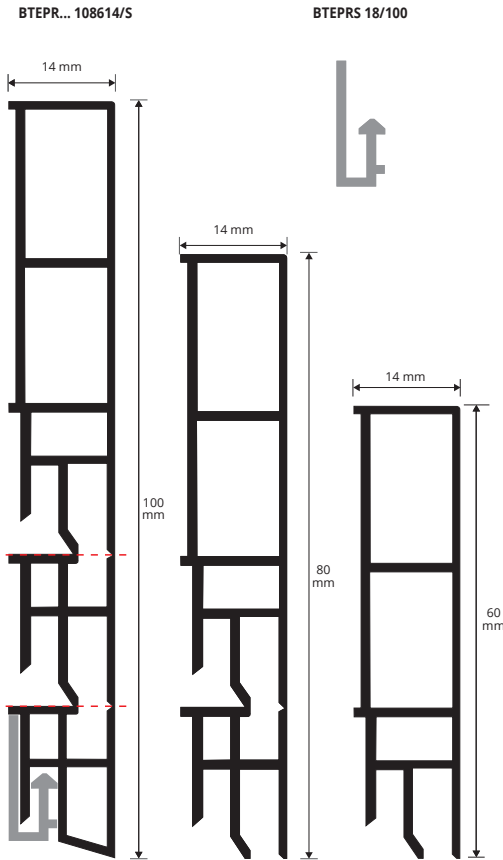

FOAMED VINYL RESIN (wood finishes - black - white and silver)  
bar length 2,4 lm - pack. 20 Pcs - 48 lm

Article	L mm		
<b>BTEPR... 108614/S</b>	<b>100/80/60</b>		

Available in the finishes: 29W - 30W - 34W - B - N - AA.  
The code of the selected colour must be added to the article code.  
E.g.: BTEPR...108614/S (chosen finish Havana oak) BTEPR34W108614/S



SUPPORT / FIXING CLIP - PLASTIC  
pack. 100 Pcs

Article	H mm		
<b>BTEPRS 18</b>	<b>16,5</b>		

Order the SUPPORT and choose the SKIRTING in the desired finish.

**USE PROBAND FIX FOR FIXING THE PROFILE TO THE WALL**



## COLOURS

<b>29W - White oak</b>	<b>30W - Grey oak</b>	<b>34W - Havana oak</b>	<b>B - White</b>	<b>N - Black</b>	<b>AA - Silver</b>

On request it is possible to realize other finishes of the color range: minimum order 400 pcs. Production delay 4/5 weeks.  
Price to be agreed. For sample finishes, contact the sales office for minimum quantities, timing and costs.

## LAYING INSTRUCTIONS

1. Choose "PROMULTISKIRT SQUARE" according to the chosen colour. 2. Cut "PROMULTISKIRT SQUARE" to the required length. 3. if necessary cut "PROMULTISKIRT SQUARE" to the required height. \* 4. Carefully clean the substrate on which the profile will be placed from oil, grease and dirt residues in general.

### Laying with adhesive only:

5a. With dry surface apply the Proband Fix. 6a. Press the profile against the wall with the correct pressure.

### Laying with adhesive and support:

5b. Fix the plastic supports to the wall every 50mm with screws. 6b. Apply Proband Fix only to the back upper part of the skirting board. 7b. Fix the profile to the supports and press it against the wall with correct pressure.

## EXAMPLE OF LAYING

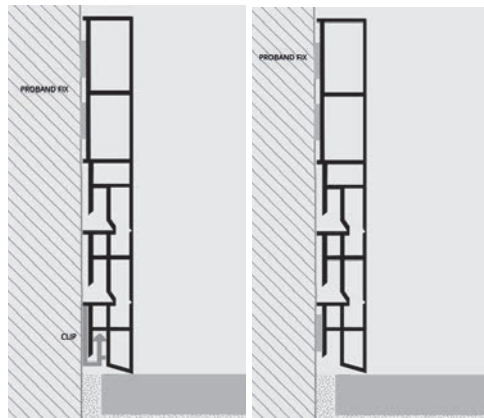

## \*CUT INSTRUCTIONS



**Option 1A:** Cut to have the height 80 mm.  
Cut along the first pre-incision on the back of the skirting;

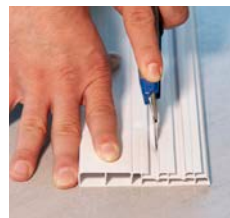

**Option 1B:** Cut to have the height 60 mm.  
Cut along the second pre-incision on the back of the skirting;



2. Cut the skirting on the front side at the cut previously made on the back;



3. Remove the excess part.

# CORNERS, END CAPS AND JOINTS

FOAMED VINYL RESIN

## INTERNAL CORNER KIT

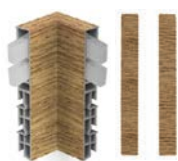

KIT BTEPR ... 108614/SI

## EXTERNAL CORNER KIT

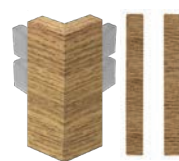

KIT BTEPR ...108614/SE

## IN/EXTERNAL CORNERS and END CAPS KIT (wood finishes - black - white and silver)

Article	H mm		
<b>KBTEPR...108614/SI</b>	<b>100/80/60</b>		
<b>KBTEPR...108614/SE</b>	<b>100/80/60</b>		

Available in the finishes: 29W - 30W - 34W - B - N - AA.  
The code of the selected colour must be added to the article code.  
E.g.: KBTEPR...108614/S (chosen finish Havana oak ) KBTEPR34W108614/S



**PROMULTISKIRT ROUND** is an expanded vinyl resin profile covered with a vinyl resin film available in white, black, silver and wood finishes. The profile has a good resistance to chemical agents and can be secured to the wall with plastic supports fixed with screws or silicone. The skirting height is 100 mm, it can be cut to 80 and 60 mm heights thanks to the pre-incisions on the back. PROMULTISKIRT ROUND in expanded vinyl resin coated with vinyl resin film is suitable for any indoor environment.

# PROMULTISKIRT ROUND

FOAMED VINYL RESIN

**PATENTED**



**FOAMED VINYL RESIN (wood finishes - black - white and silver)**  
bar length **2,4 lm** - pack **20 Pcs - 48 lm**

**SUPPORT / FIXING CLIP - PLASTIC**  
pack. **100 Pcs**

Article	L mm
<b>BTEPR... 108614/R</b>	<b>100/80/60</b>

Article	H mm
<b>BTEPRS 18</b>	<b>16,5</b>

Available in the finishes: 29W - 30W - 34W - B - N - AA.  
The code of the selected colour must be added to the article code.  
E.g.: BTEPR...108614/R (chosen finish Havana oak )BTEPR34W 108614/R

Order the SUPPORT and choose the SKIRTING in the desired finish.

**USE PROBAND FIX FOR FIXING THE PROFILE TO THE WALL**



## COLOURS

(For a precise assessment of colours request the wood finishes sample range)



On request it is possible to realize other finishes of the color range: minimum order 400 pcs. Production delay 4/5 weeks.  
Price to be agreed. For sample finishes, contact the sales office for minimum quantities, timing and costs.

## LAYING INSTRUCTIONS

1. Choose "PROMULTISKIRT ROUND" according to the chosen colour. 2. Cut "PROMULTISKIRT ROUND" to the required length. 3. if necessary cut "PROMULTISKIRT ROUND" to the required height. \* 4. Carefully clean the substrate on which the profile will be placed from oil, grease and dirt residues in general.

### Laying with adhesive only:

5a. With dry surface apply the Proband Fix. 6a. Press the profile against the wall with the correct pressure.

### Laying with adhesive and support:

5b. Fix the plastic supports to the wall every 50mm with screws. 6b. Apply Proband Fix only to the back upper part of the skirting board.

7b. Fix the profile to the supports and press it against the wall with correct pressure.



**Option 1A:** Cut to have the height 80 mm.  
Cut along the first pre-incision on the back of the skirting;

**Option 1B:** Cut to have the height 60 mm.  
Cut along the second pre-incision on the back of the skirting;

2. Cut the skirting on the front side at the cut previously made on the back;

3. Remove the excess part.

BTEPR... 108614/R

BTEPRS 18/100

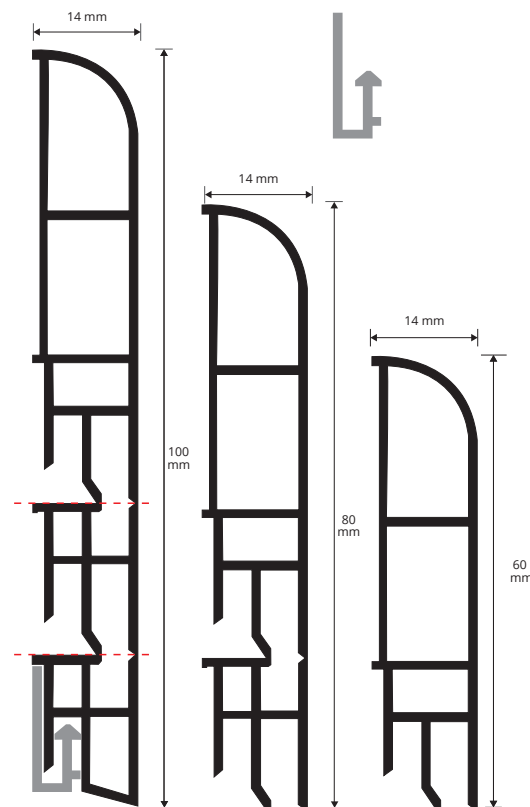

## EXAPLE OF LAYING

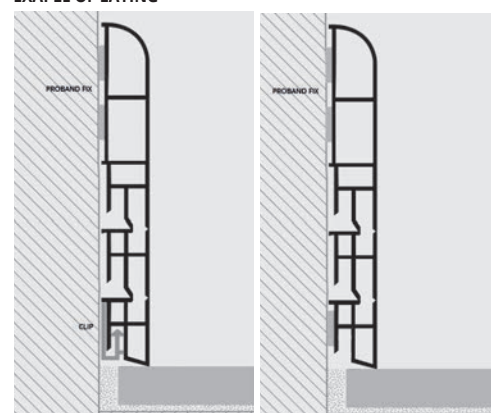

# CORNERS, END CAPS AND JOINTS

FOAMED VINYL RESIN

**IN/EXTERNAL CORNERS and END CAPS KIT**  
(wood finishes - black - white and silver)

Available in the finishes: 29W - 30W - 34W - B - N - AA.  
The code of the selected colour must be added to the article code.  
E.g.: KBTEPR...108614/S (chosen finish Havana oak ) KBTEPR34W 108614/S

Article	H mm
<b>KBTEPR...108614/RI</b>	<b>100/80/60</b>
<b>KBTEPR...108614/RE</b>	<b>100/80/60</b>

INTERNAL CORNER KIT

EXTERNAL CORNER KIT



KIT BTEPR ...108614/RI

KIT BTEPR ...108614/RE

# SKIRTING 7016

FOAMED VINYL RESIN

**SKIRTING 7016** is a vinyl resin foam profile with a height of 70 mm. available wooden finishes and finishes in solid colour that could be matched with the PROINSERT SYSTEM's profiles. The profile, suitable like skirting for floating and glued wood floor, laminate and LVT, could be laid with suitable adhesive, nails, screws or using the pre-punched support fixed to the wall with screws every 57 cm. Its special section, that allows to cover a 16 mm perimetral joint, and wide range of finishes make it a very requested, elegant and economic skirting profile.

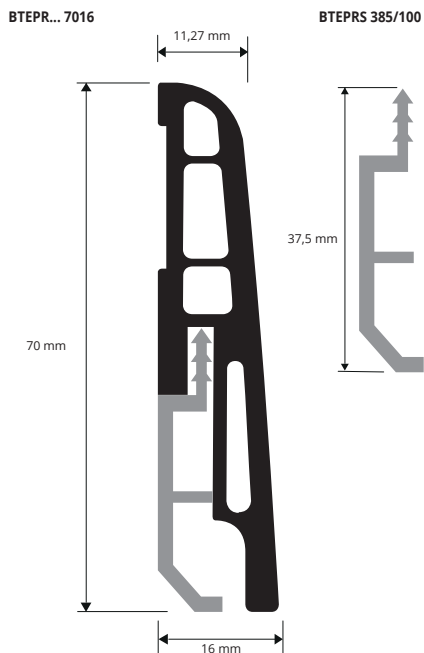

**FOAMED VINYL RESIN (wood finishes - black - white and silver)**  
Length = 2,5 m - Pack 20 pcs - 50 lm

Article	L mm
BTEPR... 7016	70

USE PROBAND FIX FOR FIXING THE PROFILE TO THE WALL



**SUPPORT / FIXING CLIP - PLASTIC**  
support Length 5 cm

Article	H mm
BTEPRS 385	37,5

Order the SUPPORT and choose the SKIRTING in the desired finish.

**IN/EXTERNAL CORNERS and END CAPS KIT**  
(wood finishes - black - white and silver)

Article	H mm
KIT BTEPR ...7016I	70
KIT BTEPR ...7016E	70

INTERNAL CORNER KIT



EXTERNAL CORNER KIT

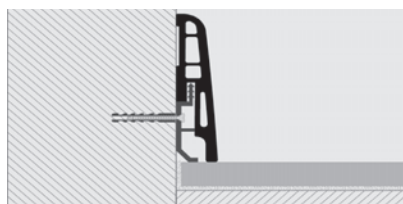

### EXAMPLES AND INSTRUCTIONS FOR LAYING METHODS

1. Choose "Skirting 7016" in the desired finish.
2. Fix the pre-punched support to the wall with screws every 50 cm.
3. Attach the profile to the support applying low pressure.
4. Alternatively fix the profile using a suitable fast adhesive, nails or screws

### COLOURS

(For a precise assessment of colours request the wood finishes sample range)

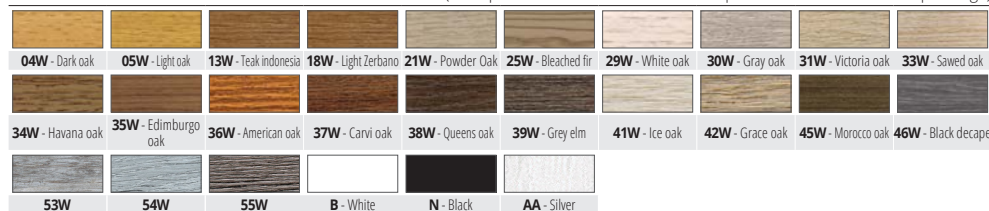

On request it is possible to realize other finishes of the color range: minimum order 400 pcs. Production delay 4/5 weeks. Price to be agreed. For sample finishes, contact the sales office for minimum quantities, timing and costs.

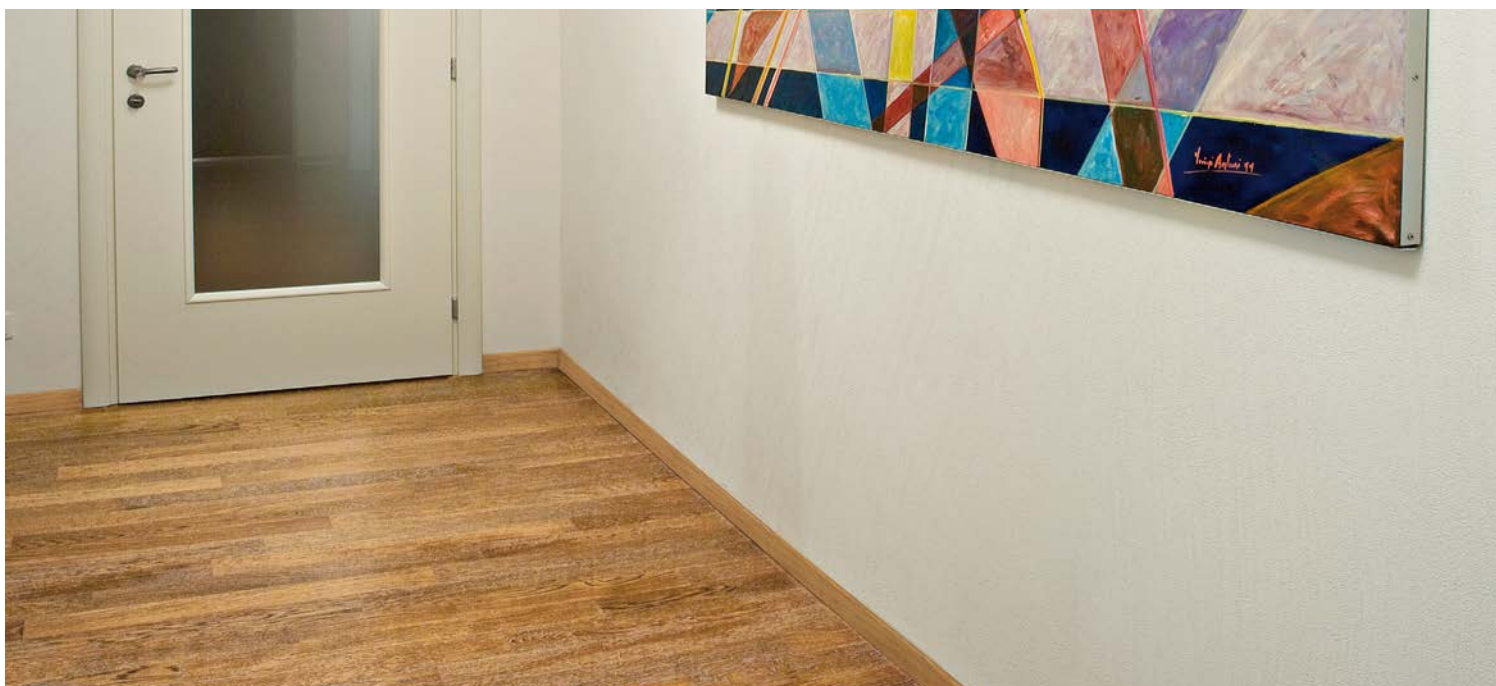





**SKIRTING 7011** is a vinyl resin foam profile with a height of 70 mm x 10,5 mm, available in wooden finishes and finishes standard colours that could be matched with the PROINSERT SYSTEM's profiles. Suitable as Basebord for floating and glued wood floor, laminate and LVT, could be laid with suitable adhesive, or else with nails .

# SKIRTING 7011

FOAMED VINYL RESIN



FOAMED VINYL RESIN (wood finishes - black - white and silver)  
Length = 2,5 m - Pack 20 pcs - 50 Lm

Article	H mm
BTEPR... 7011	70



IN/EXTERNAL CORNERS and END CAPS KIT  
(wood finishes - black - white and silver)

Article	H mm
KIT BTEPR ...7011I	70
KIT BTEPR ...7011E	70

INTERNAL CORNER KIT

EXTERNAL CORNER KIT



USE PROBAND FIX FOR FIXING THE PROFILE TO THE WALL



COLOURS

(For a precise assessment of colours request the wood finishes sample range)

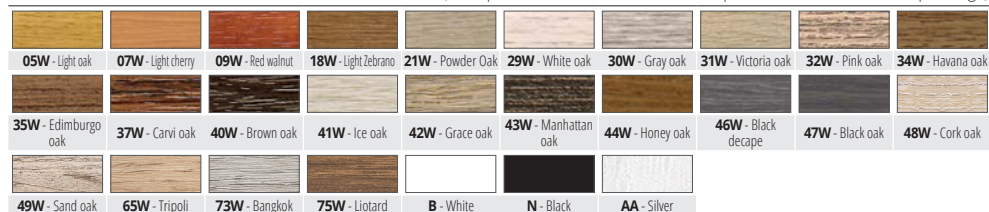

On request it is possible to realize other finishes of the color range: minimum order 400 pcs. Production delay 4/5 weeks. Price to be agreed. For sample finishes, contact the sales office for minimum quantities, timing and costs.

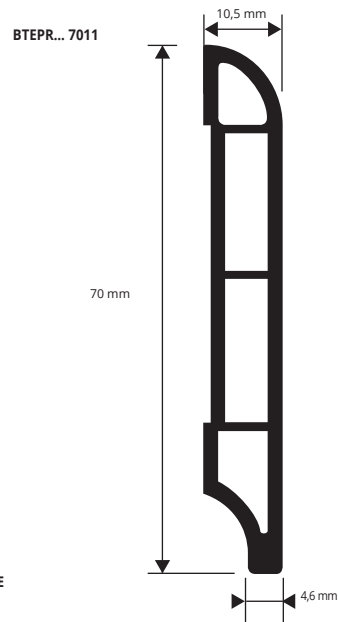

EXAMPLES AND INSTRUCTIONS FOR LAYING METHODS

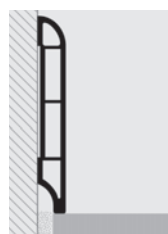

1. Choose the "Skirting 7011" in the required the colour.
2. Lay the "Skirting 7011" using quick-setting suitable adhesive for gluing flexible PVC onto mortar-plaster-accessorised walls, etc. or fix with nails.

**SKIRTING 40** is a vinyl resin foam profile with a height of 40 mm x 10 mm, available in wooden finishes and finishes standard colours that could be matched with the PROINSERT SYSTEM's profiles. Suitable as Basebord for floating and glued wood floor, laminate and LVT, could be laid with suitable adhesive, or else with nails .

# SKIRTING 40

FOAMED VINYL RESIN



FOAMED VINYL RESIN (wood finishes - black - white and silver)  
Length = 2,4 m - Pack. 20 PCS - 48 Lm

Article	H mm
BTEPR... 4010	40

Available in the finishes: 29W - 30W - 34W - B - N - AA.  
The code of the selected colour must be added to the article code.  
E.g.: BTEPR... 4010 (chosen finish Havana oak ) BTEPR34W 4010

USE PROBAND FIX FOR FIXING THE PROFILE TO THE WALL

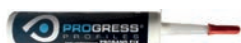

COLOURS

(For a precise assessment of colours request the wood finishes sample range)



On request it is possible to realize other finishes of the color range: minimum order 400 pcs. Production delay 4/5 weeks. Price to be agreed. For sample finishes, contact the sales office for minimum quantities, timing and costs.

IN/EXTERNAL CORNERS and END CAPS KIT  
(wood finishes - black - white and silver)

Article	H mm
KIT BTEPR ...4010I	40
KIT BTEPR ...4010E	40

INTERNAL CORNER KIT

EXTERNAL CORNER KIT



BTEPR... 4010

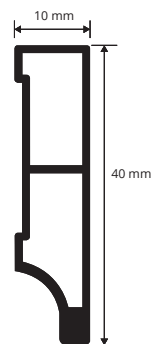

EXAMPLES AND INSTRUCTIONS FOR LAYING METHODS

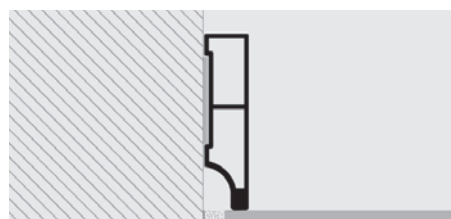

1. Choose the "Skirting 40" in the required the colour.
2. Lay the "Skirting 40" using quick-setting suitable adhesive for gluing flexible PVC onto mortar-plaster-accessorised walls, etc. or fix with nails.

# PROSEAL WOOD

EXPANDED PVC  
2 WOOD FINISHING AND 4 MATCHING COLOURS

PSAW... 20

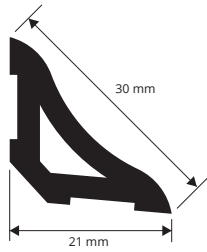

## EXAMPLES AND INSTRUCTIONS FOR LAYING METHODS

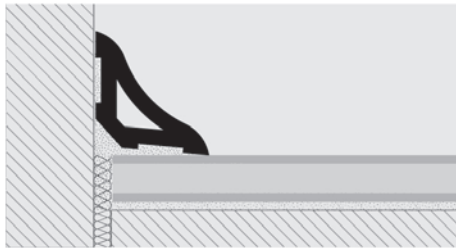

1. Choose "PROSEAL WOOD" color and/or wood finish required.
2. The laying must be carried out using fast fixing acrylic silicone, mastic, bostik suitable for gluing PVC with mortar - plaster - wall units etc., or fix using screws/nails.

**PROSEAL WOOD** is a new inner connector square suitable for creating a concave skirting for wood / rolled-melamine floating wood / ceramic / marble tiles to reduce the floor /covering detachment. The particular material used allows to resist to the main chemical agents ant to small breakages. **PROSEAL WOOD's** dimensions allow the necessary expansion of the outer joint. Ideal for public (schools, rest homes, recreational area) and private places. In expanded PVC , in 2 wood finishes 4 in matching colours to combine with various wood finishes. Easy to lay with fixing silicone.



EXPANDED PVC - 2 WOOD FINISHING  
bar length 2,5 lm - pack. 40 Pcs - 100 lm

Article	L mm
PSAW... 20	21 x 21

Available in the wood finishes: 05W - 10W , and colours: B - GC - GS - N.  
The code of the selected colour must be added to the article code. E.g.: PSAW...20 (chosen finish black) PSAWN 20.



EXPANDED PVC - 4 COLOURS  
bar length 2,5 lm - pack. 40 Pcs - 100 lm

Article	L mm
PSAW... 20	21 x 21

USE PROBAND FIX FOR FIXING THE PROFILE TO THE WALL



## COLOURS

B - White	GC - Light gray	GS - Dark gray	N - Black	05W - Light oak (strip)	10W - Wengé (panga panga-wengé)

The shade of the wooden finish in rigid expanded vinyl resin/PVC results slightly different from the film usually applied on the profiles in aluminium.

# PROANGLE WOOD

EXPANDED PVC  
2 WOOD FINISHING AND 4 MATCHING COLOURS

PGAW... 15

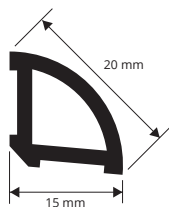

## EXAMPLES AND INSTRUCTIONS FOR LAYING METHODS

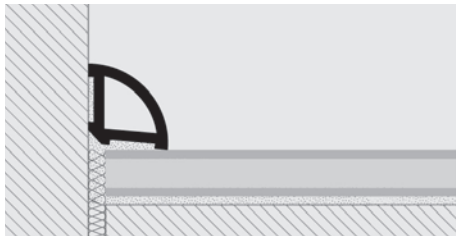

1. Choose "PROANGLE WOOD" color and/or wood finish required.
2. The laying must be carried out using fast fixing acrylic silicone, mastic, bostik, suitable for gluing PVC with mortar-plaster-wall units etc., or fix using screws/nails.

**PROANGLE WOOD** is a new inner connector square suitable for creating a convex skirting for wood / rolled-melamine floating wood / ceramic / marble floor to reduce the floor /covering detachment. The particular material used allows to resist to the main chemical agents and to small breakages. **PROANGLE WOOD's** dimensions allow the necessary expansion of the outer joint. Ideal for public (schools, rest homes, recreational area) and private places. In expanded PVC , in 2 wood finishes 4 in matching colors to combine with various wood finishes. Easy to lay with fixing silicone.

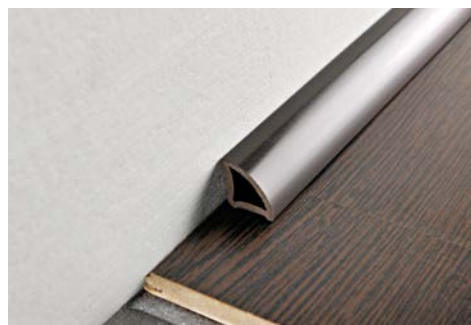

EXPANDED PVC - 2 WOOD FINISHING  
bar length 2,5 lm - pack. 40 Pcs - 100 lm

Article	L mm
PGAW... 15	15 x 15

Available in the wood finishes: 05W - 10W, and colours: - GC - GS - N.  
The code of the selected colour must be added to the article code. E.g.: PGAW...15 (chosen finish black) PGAWN 15.



EXPANDED PVC - 4 COLOURS  
bar length 2,5 lm - pack. 40 Pcs - 100 lm

Article	L mm
PGAW... 15	15 x 15

USE PROBAND FIX FOR FIXING THE PROFILE TO THE WALL



## COLOURS

B - White	GC - Light gray	GS - Dark gray	N - Black	05W - Light oak (strip)	10W - Wengé (panga panga-wengé)

The shade of the wooden finish in rigid expanded vinyl resin/PVC results slightly different from the film usually applied on the profiles in aluminium.



**SKIRTING** in PVC foam height 70 mm in 12 finishes: 4 in semi-matt black-grey-white and 8 wooden finishes to be matched with the PROINSERT SYSTEM profiles for floating laminated wood floors and traditional parquet floors. Laying is done by gluing (acetic silicone - acrylic - mastic) or using screws or nails. Attractive, strong, hardwearing and economic, it is easy to lay and ideal for many public premises (hospitals, schools, gymnasiums, rest homes and creative areas) and private environments. Easy to match with many wood species.

# SKIRTING

EXPANDED VINYL RESIN



**EXPANDED RIGID VINYL RESIN (black - light and dark grey - white)**  
bar length **2 lm** - pack. **60 Pcs - 120 lm**

Article	H mm
BTPR... 70	70

**EXPANDED RIGID VINYL RESIN (8 wooden finishes)**  
bar length **2 lm** - pack. **60 Pcs - 120 lm**

Article	H mm
BTPR... 70	70

Available in the colours: B - GC - GS - N - 04W - 05W - 06W - 07W - 08W - 09W - 10W - M.  
The code of the selected colour must be added to the article code. E.g.: BTPR... 70 (chosen colour black) BTPRN 70.

## COLOURS

<b>B</b> - White	<b>GC</b> - Light grey	<b>GS</b> - Dark grey	<b>N</b> - Black	<b>04W</b> - Dark beech	<b>05W</b> - Light oak (strip)
<b>06W</b> - Dark oak (Walnut)	<b>07W</b> - Light cherry (strip)	<b>08W</b> - Dark cherry (board)	<b>09W</b> - Red walnut (Merbau-Apple-Walnut)	<b>10W</b> - Wengé (Panga-Panga - Wengé)	<b>M</b> - Mahogany

The shade of the wooden finish in rigid expanded vinyl resin/pvc results slightly different from the film usually applied on the profiles in aluminum.

BTPR...70



## EXAMPLES AND INSTRUCTIONS FOR LAYING METHODS

1. Choose the "SKIRTING" in the required the colour. 2. Lay the skirting using quick-setting acrylic silicone, mastic or bostik, suitable for gluing flexible PVC onto mortar-plaster-accessorised walls, etc. or fix with screws/nails.

USE PROBAND FIX FOR FIXING THE PROFILE TO THE WALL

**ANGLE BAR** produced in expanded PVC in 12 finishes: 4 colours in semi-matt, black-grey-white and 8 wooden finishes used to protect angles. Laying is done by gluing (acetic silicone - acrylic - mastic) or using screws or nails. Attractive, strong, hardwearing and economic, it is easy to lay and ideal for many public premises (hospitals, schools, gymnasiums, rest homes and creative areas) and private environments. Easy to match with many wood species.

# ANGLE BAR

EXPANDED VINYL RESIN



**EXPANDED RIGID VINYL RESIN (black - light and dark grey - white)**  
bar length **2,7 lm** - pack. **40 Pcs - 108 lm**

Article	L x H mm
AGE... 25	25 x 25

**EXPANDED RIGID VINYL RESIN (8 wooden finishes)**  
bar length **2,7 lm** - pack. **40 Pcs - 108 lm**

Article	L x H mm
AGE... 25	25 x 25

Available in the colours: B - GC - GS - N - 04W - 05W - 06W - 07W - 08W - 09W - 10W - M.  
The code of the selected colour must be added to the article code. E.g.: AGE... 25 (chosen colour black) AGEN 25.

The shade of the wooden finish in rigid expanded vinyl resin/pvc results slightly different from the film usually applied on the profiles in aluminum.

AGE...25

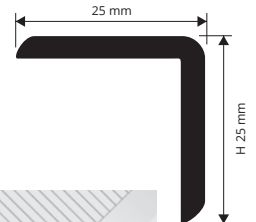

## EXAMPLE OF LAYING

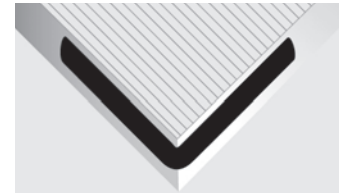

USE PROBAND FIX FOR FIXING THE PROFILE TO THE WALL

## LVT PROFILES - SOL 30P

ALUMINIUM ANODIZED FINISHES AND WOODEN FINISHES

**ALUMINIUM TOP** 80 wooden fin. "...W" (56 on demand), 6 anodized fin. (3 on demand) **thermo packed** - bar length **2,7 lm** - pack. **20 Pcs - 54 lm**

Article	L mm
PNSP... 3046	30
PNSP...W 3046	30

Available in the anodized finishes: AO - AA - AB (AT, CH and SB on demand with a minimum quantity order of 200 pcs) 05W - 09W - 13W - 18W - 21W - 25W - 29W - 30W - 31W - 33W - 34W - 36W - 37W - 38W - 39W - 41W - 42W - 43W - 44W - 45W - 46W - 47W - 48W - 49W. The code of the selected colour must be added to the article code. E.g.: PNSP... 3046 (chosen finish anod. gold) PNSPAO 3046.

**ALUMINIUM TOP** (anod. silver) **thermo packed** - bar length **2,7 lm** - pack. **20 Pcs - 54 lm**

Article	L mm
PNSPAA 4046	40



**BASE** (vinyl resin/PVC) - bar length **2,7 lm**

Article	L mm
PINBFT 3646	36



## LVT PROFILES - ZERO CURVE

ALUMINIUM ANODIZED FINISHES AND WOODEN FINISHES

**ALUMINIUM TOP** 80 wooden fin. "...W" (56 on demand), 6 anodized fin. (3 on demand) **thermo packed** - bar length **2,7 lm** - pack. **20 Pcs - 54 lm**

Article	L mm
PINZ... 2646	26
PINZ...W 2646	26

**ALUMINIUM TOP** (anod. silver) **thermo packed** - bar length **2,7 lm** - pack. **20 Pcs - 54 lm**

Article	L mm
PINZAA 3246	32



**BASE** (vinyl resin/PVC) - bar length **2,7 lm**

Article	L mm
PINBFT 2346	23



## LVT PROFILES - TERMINAL PIN

ALUMINIUM ANODIZED FINISHES AND WOODEN FINISHES

**ALUMINIUM TOP** 80 wooden fin. "...W" (56 on demand), 6 anodized fin. (3 on demand) **thermo packed** - bar length **2,7 lm** - pack. **20 Pcs - 54 lm**

Article	L mm
PINTP... 1946	19
PINTP...W 194	19

**ALUMINIUM TOP** (anod. silver) **thermo packed** - bar length **2,7 lm** - pack. **20 Pcs - 54 lm**

Article	L mm
PINTPAA 2546	25



**BASE** (vinyl resin/PVC) - bar length **2,7 lm**

Article	L mm
PINBFT 2346	23





## SOL 30 (only top)

WOODEN-FINISHES AND ANODIZED FINISHES

joints

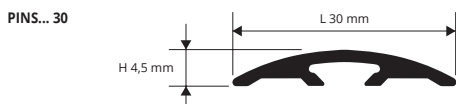

**ANODIZED ALUMINIUM** (6 anod. alum. finishes of which 3 on demand)  
thermo packed - bar length 2,7 lm - pack. 40 Pcs - 108 lm

Article	L mm		
PINS... 30	30		

Available in the anodized finishes: AO - AA - AB (AT, CH and SB available on demand with a minimum quantity order of 200 pcs), 04W - 05W - 07W - 09W - 13W - 18W - 21W - 25W - 29W - 30W.  
The code of the selected colour must be added to the article code. E.g.: PINS... 30 (chosen finish anod. gold) PINSAO 30.

**ALUMINIUM COVERED** (80 wooden finishes f which 71 on demand)  
thermo packed - bar length 2,7 lm - pack. 40 Pcs - 108 lm

Article	L mm		
PINS... 30	30		

## TERMINAL PIN (only top)

WOODEN-FINISHES AND ANODIZED FINISHES

terminal profiles

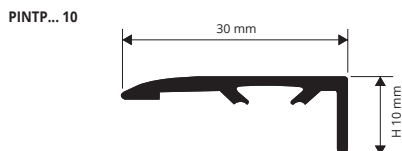

**ANODIZED ALUMINIUM** (6 anod. alum. finishes of which 3 on demand)  
thermo packed - bar length 2,7 lm - pack. 40 Pcs - 108 lm

Article	L mm		
PINTP... 10	10		

Available in the colours: AO - AA - AB (AT, CH and SB on demand with a minimum quantity order of 200 pcs) 04W - 05W - 07W - 09W - 13W - 18W - 21W - 25W - 29W - 30W - 31W - 32W - 33W - 34W - 35W - 36W - 37W - 38W - 39W - 41W - 42W - 44W - 45W - 46W - 48W - 49W - 53W - 54W - 55W - 65W - 73W - 75W.  
The code of the selected colour must be added to the article code. E.g.: PINTP... 10 (chosen finish anod. gold) PINTPAO 10.

**ALUMINIUM COVERED** (80 wooden finishes f which 49 on demand)  
thermo packed - bar length 2,7 lm - pack. 40 Pcs - 108 lm

Article	L mm		
PINTP...	10		

## ZERO CURVE 07-09-13-15 (only top)

WOODEN-FINISHES AND ANODIZED FINISHES

transition profiles

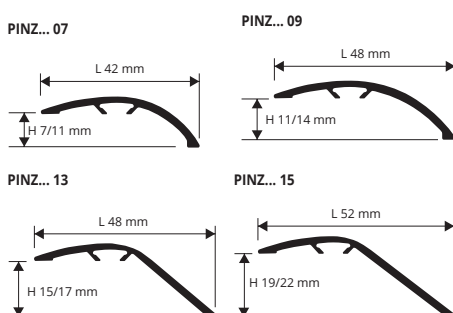

**ANODIZED ALUMINIUM** (6 anod. alum. finishes of which 3 on demand)  
thermo packed - bar length 2,7 lm  
pack. 20 Pcs - 54 lm (H 7 - H 9 mm - 108 lm)

Article	H mm		
PINZ... 07	7 / 11		
PINZ... 09	11 / 14		
PINZ... 13	15 / 17		
PINZ... 15	19 / 22		

Available in the anodized finishes: AO - AA - AB (AT, CH and SB on demand with a minimum quantity order of 200 pcs) 04W - 05W - 07W - 09W - 13W - 18W - 21W - 25W - 29W - 30W - 31W - 32W - 33W - 34W - 35W - 36W - 37W - 38W - 39W - 41W - 42W - 44W - 45W - 46W - 48W - 49W - 53W - 54W - 55W - 65W - 73W - 75W.  
The code of the selected colour must be added to the article code. E.g.: PINZ... 07 (chosen finish anod. gold) PINZAO 07.

**ALUMINIUM COVERED** (80 wooden finishes f which 49 on demand)  
thermo packed - bar length 2,7 lm  
pack. 20 Pcs - 54 lm (H 7 - H 9 mm - 108 lm)

Article	H mm		
PINZ... 07	7 / 11		
PINZ... 09	11 / 14		
PINZ... 13	15 / 19		
PINZ... 15	19 / 22		

## STYLE STAIR (only top)

WOODEN-FINISHES AND ANODIZED FINISHES

stair nosing profiles

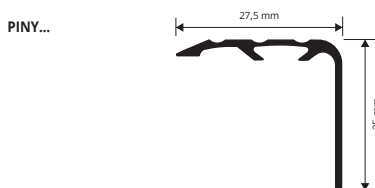

**ANODIZED ALUMINIUM** (6 anod. alum. finishes of which 3 on demand)  
thermo packed - bar length 2,7 lm - pack. 20 Pcs - 54 lm

Article	L x H mm		
PINY...	27,5 x 25		

Available in the colours: AO - AA - AB (AT, CH and SB on demand with a minimum quantity order of 200 pcs) 05W - 07W - 09W - 18W - 21W - 25W - 29W - 30W - 31W - 32W - 33W - 34W - 35W - 36W - 37W - 38W - 39W - 41W - 42W - 44W - 45W - 53W - 54W - 55W.  
The code of the selected colour must be added to the article code. E.g.: PINY... (chosen finish anod. gold) PINYAO.

**ALUMINIUM COVERED** (80 wooden finishes f which 60 on demand)  
thermo packed - bar length 2,7 lm - pack. 10 Pcs - 27 lm

Article	L x H mm		
PINY...	27,5 x 25		

## STYLE STAIR L (only top)

WOODEN-FINISHES AND ANODIZED FINISHES

stair nosing profiles

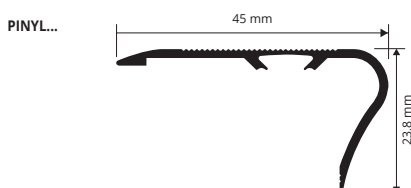

**ANODIZED ALUMINIUM** (6 anod. alum. finishes of which 3 on demand)  
thermo packed - bar length 2,7 lm - pack. 20 Pcs - 54 lm

Article	L x H mm		
PINYL...	45 x 23,8		

Available in the colours: AO - AA - AB (AT, CH and SB on demand with a minimum quantity order of 200 pcs), 04W - 05W - 13W - 18W - 21W - 25W - 29W - 30W - 31W - 32W - 33W - 34W - 35W - 36W - 37W - 38W - 39W - 41W - 42W - 44W - 45W - 53W - 54W - 55W.  
The code of the selected colour must be added to the article code. E.g.: PINYL... (chosen finish anod. gold) PINYAO.

**ALUMINIUM COVERED** (80 wooden finishes f which 57 on demand)  
thermo packed - bar length 2,7 lm - pack. 10 Pcs - 27 lm

Article	L x H mm		
PINYL...	45 x 23,8		

## SOL 40 P (only top)

WOODEN-FINISHES AND ANODIZED FINISHES

joints

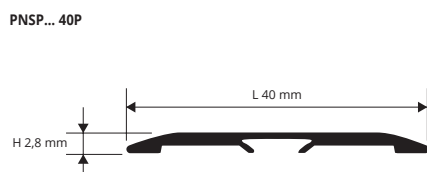

**ANODIZED ALUMINIUM** (6 anod. alum. finishes of which 3 on demand)  
thermo packed - bar length 2,7 lm - pack. 40 Pcs - 108 lm

Article	L x H mm		
PNSP... 40P	40		

Available in the colours: AO - AA - AB (AT, CH and SB on demand with a minimum quantity order of 200 pcs) 04W - 05W - 07W - 09W - 13W - 18W - 21W - 25W - 29W - 30W - 31W - 32W - 33W - 34W - 35W - 36W - 37W - 38W - 39W - 41W - 42W - 44W - 45W - 46W - 48W - 49W - 53W - 54W - 55W - 65W - 73W - 75W.  
The code of the selected colour must be added to the article code. E.g.: PNSP... 40P (chosen finish anod. gold) PNSPAO 40P.

**ALUMINIUM COVERED** (80 wooden finishes f which 49 on demand)  
thermo packed - bar length 2,7 lm - pack. 10 Pcs - 27 lm

Article	L x H mm		
PNSP... 40P	40		

# INTERCHANGEABLE INSERT

RIGID IMPACT-RESISTANT  
NO-TOXIC VINYL RESIN

RIGID IMPACT-RESISTANT NO-TOXIC VINYL RESIN  
bar length 2,7 LM - pack. 20 Pcs - 54 LM

Article	H mm		
PIN 07	7		
PIN 09	9		
PIN 11	11		
PIN 13	13		
PIN 15	15		
PIN 17	17		
PIN 19	19		

FOR SOL 40 P AND TERMINAL PIN

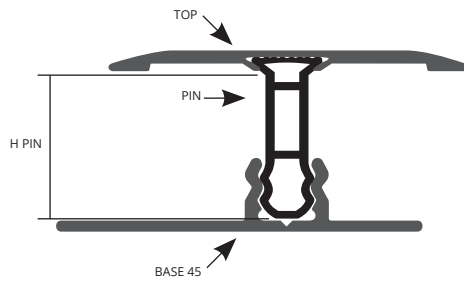

RIGID IMPACT-RESISTANT NO-TOXIC VINYL RESIN  
bar length 2,7 lm - pack. 20 Pcs - 54 lm

Article	H mm		
PIN 09	9		
PIN 11	11		
PIN 13	13		
PIN 15	15		
PIN 17	17		
PIN 19	19		

FOR ZERO CURVE, STYLE STAIR

For a correct assembly, see the drawings of the complete products in the previous pages

PIN 07

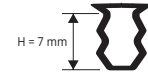

PIN 09

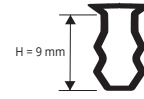

PIN 11

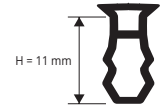

PIN 13

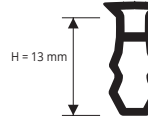

PIN 15

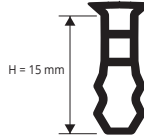

PIN 17

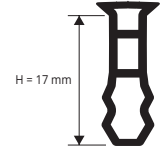

PIN 19

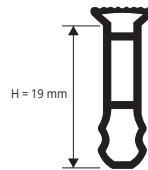

# PROINSERT BASE 45 AND BASE 40

NATURAL ALUMINIUM



ALUM. PUNCHED/PERFOR FOR SOL 30-40-50 AND ZERO CURVE  
bar length 2,7 lm - pack. 20 Pcs - 54 lm

Article	width mm		
PINBFT 45	45		
PINBFT 40	40		

PINBFT 45



PINBFT 40

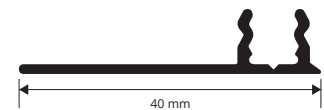

# SCREWS and SCREW ANCHORS to fix all perforated version

NICKEL-PLATED

NICKEL - PLATED FLATHEAD SCREWS + SCREW ANCHORS  
pack. 1.000 Pcs

Article	Ø mm	length mm	
VINIPT 325	03	25	

BRASS - PLATED FLATHEAD SCREWS + SCREW ANCHORS  
pack. 1.000 Pcs

Article	Ø mm	length mm	
VIOPT 325	03	25	

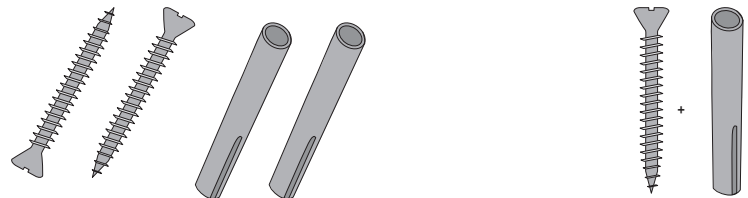

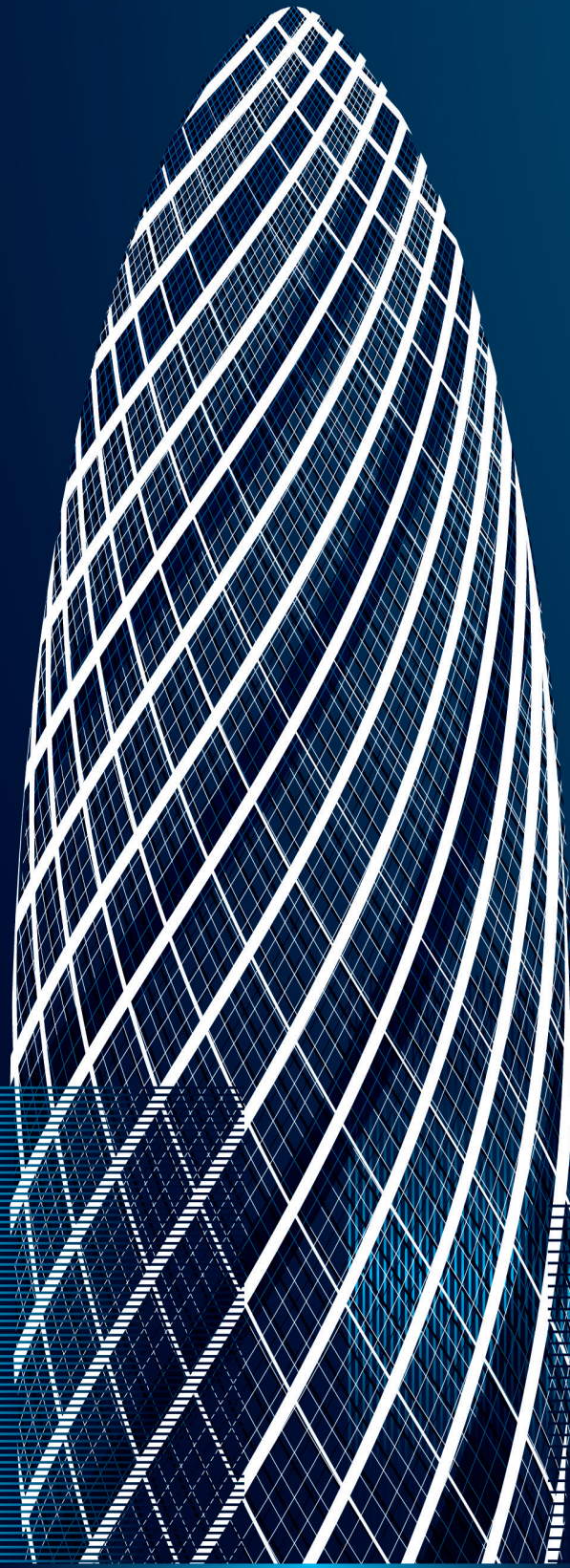

An interpretation of:  
**The Gherkin, Norman Foster, LONDON (England), 2004**



PROFILES & SYSTEMS

DO IT YOUR SELF PROFILES





## CORNER EQUAL SIDES

POLISHED STAINLESS STEEL 1.4016

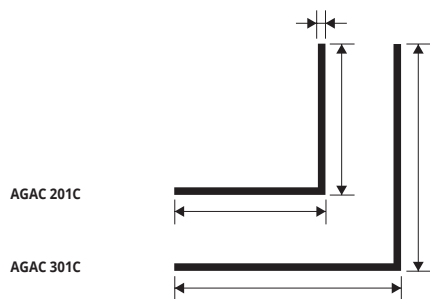

**POLISHED STAINLESS STEEL 1.4016 with protective film**  
thick 1 mm - bar length 2 lm - pack. 10 Pcs - 20 lm

Article	L x H mm		
AGAC 201C	20 x 20		
AGAC 301C	30 x 30		

On demand are available 1 lm bars.

### COLOURS



AC - Polished stainless steel 1.4016

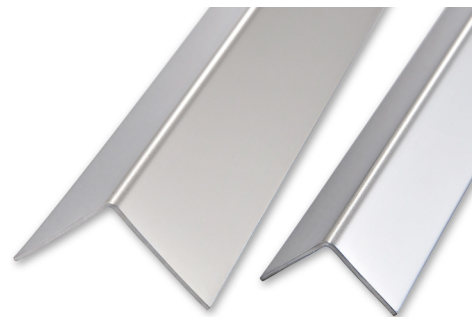

## CORNER EQUAL SIDES

POLISHED BRASS

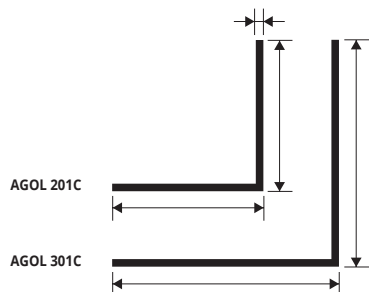

**POLISHED BRASS with protective film**  
thick 1 mm - bar length 2 lm - pack. 10 Pcs - 20 lm

Article	L x H mm		
AGOL 201C	20 x 20		*
AGOL 301C	30 x 30		

On demand are available 1 lm bars.

### COLOURS

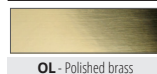

OL - Polished brass

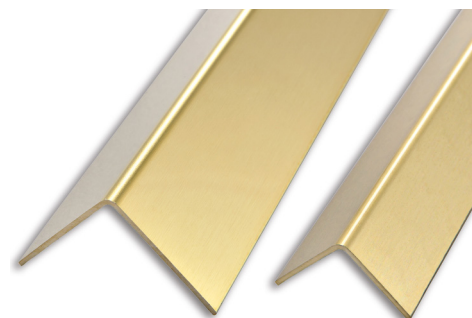

## CORNER EQUAL SIDES

ANODIZED GOLD AND SILVER, POLISHED CHROME AND WHITE VARNISHED ALUMINIUM

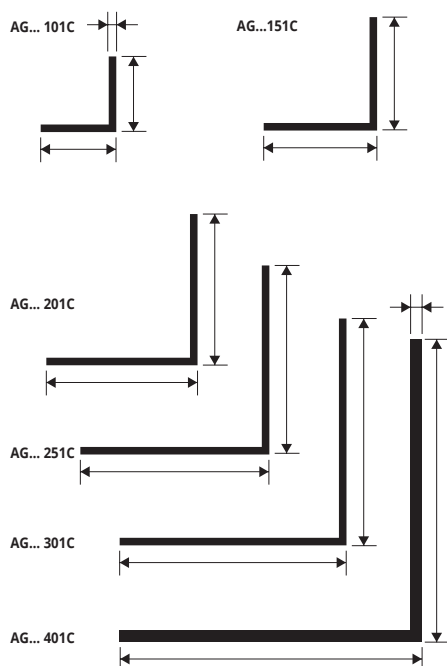

**ANODIZED GOLD and SILVER ALUMINIUM thermo packed**  
bar length 2 lm - pack. 10 Pcs - 20 lm

Article	L x H mm		
AG... 101C	10 x 10		
AG... 151C	15 x 15		
AG... 201C	20 x 20		
AG... 251C	25 x 25		
AG... 301C	30 x 30		
AG... 401C	40 x 40		

Available in the finishes: AO - AA.  
The code of the selected colour must be added to the article code.  
E.g.: AG... 101C (chosen finish anodized gold) AGAO 101C.

**POLISHED CHROME ALUMINIUM thermo packed**  
bar length 2 lm - pack. 10 Pcs - 20 lm

Article	L x H mm		
AGBC 101C	10 x 10		
AGBC 151C	15 x 15		
AGBC 201C	20 x 20		
AGBC 251C	25 x 25		
AGBC 301C	30 x 30		
AGBC 401C	40 x 40		

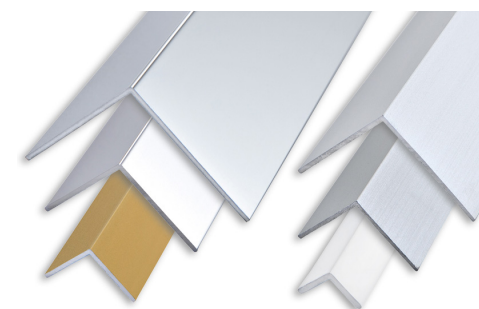

**WHITE VARNISHED ALUMINIUM thermo packed**  
bar length 2 lm - pack. 10 Pcs - 20 lm

Article	L x H mm		
AGB 101C	10 x 10		
AGB 151C	15 x 15		
AGB 201C	20 x 20		
AGB 251C	25 x 25		
AGB 301C	30 x 30		
AGB 401C	40 x 40		

On demand are available 1 lm bars.

### COLOURS



AO - Anodized gold alum. AA - Anodized silver alum. BC - Polished chrome alum. B - White varnished alum.

\* = Production on demand with minimum quantity of 100 pcs. Production delay 4/5 weeks. Price to be agreed



# CORNER EQUAL SIDES

NON - TOXIC VINYL RESIN

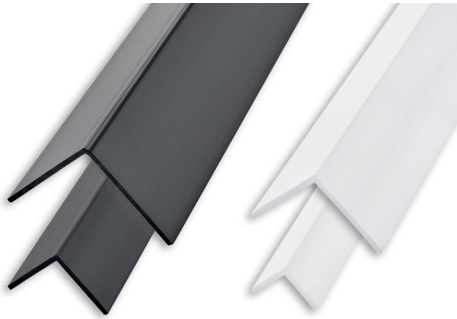

## NON - TOXIC VINYL RESIN

bar length 2 lm - pack. 10 Pcs - 20 lm

Article	L x H mm		
AGP10...C	10 x 10		
AGP15...C	15 x 15		
AGP20...C	20 x 20		
AGP25...C	25 x 25		

Available in the colours: B-N.

The code of the selected colour must be added to the article code.  
E.g.: AGP10...C (colour white) AGP10BC.

On demand are available 1 lm bars.

## COLOURS

B - White	N - Black

AGP10...C

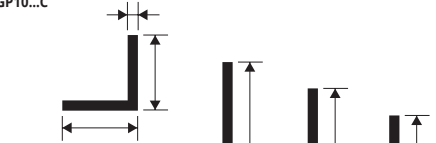

AGP15...C

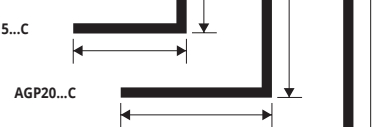

AGP20...C

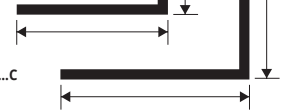

AGP25...C

# CORNER "L-FORM"

ANODIZED GOLD AND SILVER, POLISHED CHROME AND WHITE VARNISHED ALUMINIUM

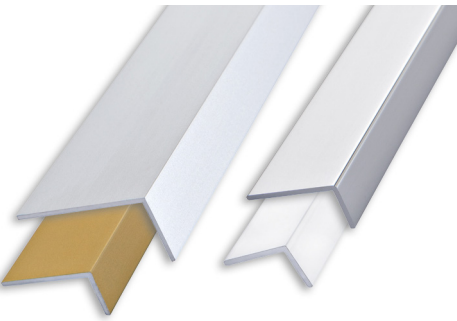

## ANODIZED GOLD AND SILVER ALUMINIUM thermo packed

bar length 2 lm - pack. 10 Pcs - 20 lm

Article	L x H mm		
AL... 1510C	15 x 10		
AL... 1020C	20 x 10		
AL... 3015C	30 x 15		

Available in the finishes: AO - AA.

The code of the selected colour must be added to the article code.  
E.g.: AL... 1510C (chosen finish anodized gold) ALAO1510C.

## POLISHED CHROME ALUMINIUM thermo packed

bar length 2 lm - pack. 10 Pcs - 20 lm

Article	L x H mm		
ALBC 1510C	15 x 10		
ALBC 1020C	20 x 10		
ALBC 3015C	30 x 15		

## WHITE VARNISHED ALUMINIUM thermo packed

bar length 2 lm - pack. 10 Pcs - 20 lm

Article	L x H mm		
ALB 1510C	15 x 10		
ALB 3015C	30 x 15		

On demand are available 1 lm bars.

AL... 1510C

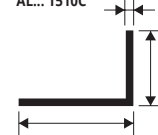

AL... 1020C



AL... 3015C



## COLOURS

AO - Anodized gold alum.	AA - Anodized silver alum.	BC - Polished chrome alum.		
<table border="1"> <tbody> <tr> <td style="background-color: white;"></td> </tr> <tr> <td>B - White varnished alum.</td> </tr> </tbody> </table>				B - White varnished alum.
B - White varnished alum.				

# CORNER "L-FORM"

NON - TOXIC VINYL RESIN

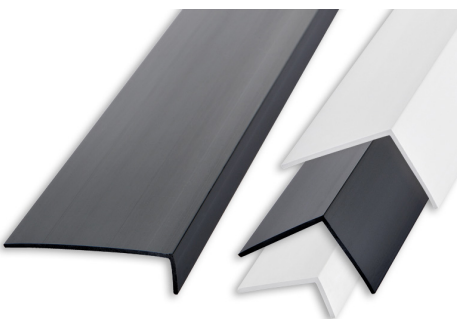

## NON TOXIC VINYL RESIN

bar length 2 lm - pack. 10 Pcs - 20 lm

Article	L x H mm		
ALP20...C	20 x 10		
ALP25...C	25 x 20		
ALP30...C	30 x 20		
ALP40...C	40 x 10		

Available in the colours: B-N.

The code of the selected colour must be added to the article code.  
E.g.: ALP20...C (colour white) ALP20BC.

On demand are available 1 lm bars.

## COLOURS

B - White	N - Black

ALP20...C

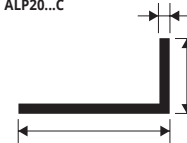

ALP25...C

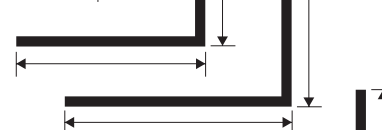

ALP30...C

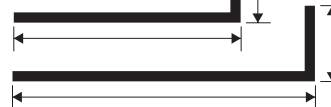

ALP40...C





## CANAL "U FORM"

ANODIZED GOLD AND SILVER, POLISHED CHROME AND WHITE VARNISHED ALUMINIUM

CU... 081C

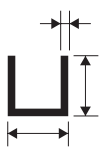

CU... 101C

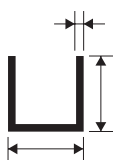

CU... 151C

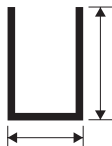

CU... 201C

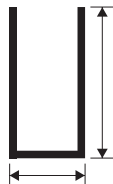

### ANODIZED GOLD AND SILVER ALUMINIUM thermo packed

bar length 2 lm - pack. 10 Pcs - 20 lm

Article	L x H mm		
CU... 081C	8 x 8		
CU... 101C	10 x 10		
CU... 151C	10 x 15		
CU... 201C	10 x 20		

Available in the finishes: AO - AA.

The code of the selected colour must be added to the article code.  
E.g.: CU... 101C (chosen finish anodized gold) CUAO 101C.

### POLISHED CHROME ALUMINIUM thermo packed

bar length 2 lm - pack. 10 Pcs - 20 lm

Article	L x H mm		
CUBC 081C	8 x 8		
CUBC 101C	10 x 10		
CUBC 151C	10 x 15		

### WHITE VARNISHED ALUMINIUM thermo packed

bar length 2 lm - pack. 10 Pcs - 20 lm

Article	L x H mm		
CUB 081C	8 x 8		
CUB 101C	10 x 10		
CUB 151C	10 x 15		
CUB 201C	10 x 20		*

On demand are available 1 lm bars.

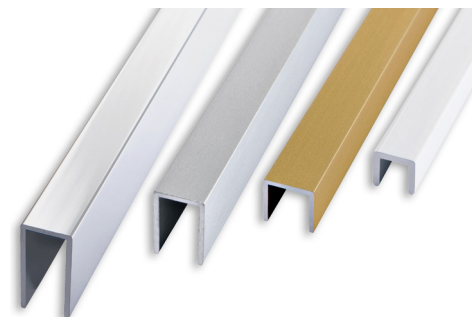

### COLOURS

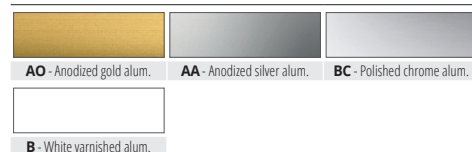

## CANAL DOUBLE "U FORM"

ANODIZED GOLD AND SILVER, POLISHED CHROME AND WHITE VARNISHED ALUMINIUM

CW... 167C

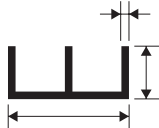

CW... 161C

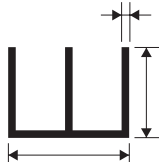

CW... 201C



CW... 208C

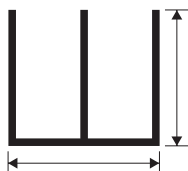

### ANODIZED GOLD AND SILVER ALUMINIUM thermo packed

bar length 2 lm - pack. 10 Pcs - 20 lm

Article	L x H mm		
CW... 167C	16 x 7		
CW... 161C	16 x 12		
CW... 201C	20 x 10		
CW... 208C	20 x 18		

Available in the finishes: AO - AA.

The code of the selected colour must be added to the article code.  
E.g.: CW... 167C (chosen finish anodized gold) CWAO 167C.

### POLISHED CHROME ALUMINIUM thermo packed

bar length 2 lm - pack. 10 Pcs - 20 lm

Article	L x H mm		
CWBC 167C	16 x 7		
CWBC 161C	16 x 12		
CWBC 201C	20 x 10		
CWBC 208C	20 x 18		

### WHITE VARNISHED ALUMINIUM thermo packed

bar length 2 lm - pack. 10 Pcs - 20 lm

Article	L x H mm		
CWB 161C	16 x 12		
CWB 208C	20 x 18		*

On demand are available 1 lm bars.

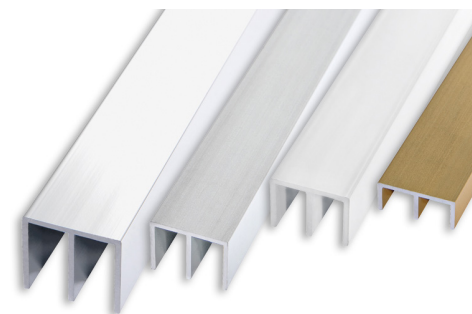

### COLOURS

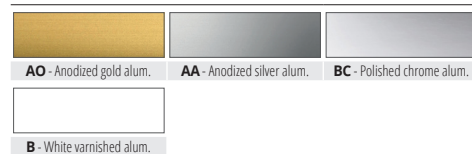

\* = Production on demand with minimum quantity of 100 pcs. Production delay 4/5 weeks. Price to be agreed



# FLAT

ANODIZED GOLD AND SILVER, POLISHED CHROME AND WHITE VARNISHED ALUMINIUM

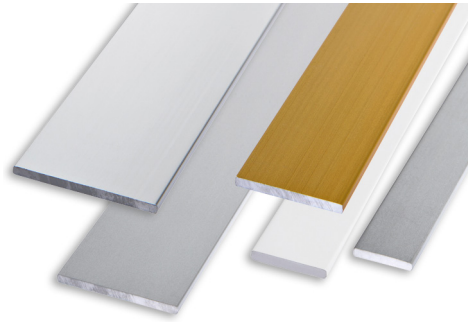

**ANODIZED GOLD AND SILVER ALUMINIUM thermo packed**  
bar length 2 lm - pack. 10 Pcs - 20 lm

Article	L mm		
PI... 102C	10		
PI... 122C	12		
PI... 152C	15		
PI... 202C	20		
PI... 252C	25		
PI... 302C	30		
PI... 402C	40		

Available in the finishes: AO - AA.  
The code of the selected colour must be added to the article code.  
E.g.: PI... 122C (chosen finish anodized gold) PIAO 122C.

**POLISHED CHROME ALUMINIUM thermo packed**  
bar length 2 lm - pack. 10 Pcs - 20 lm

Article	L mm		
PIBC 102C	10		
PIBC 122C	12		
PIBC 152C	15		
PIBC 202C	20		
PIBC 252C	25		
PIBC 302C	30		
PIBC 402C	40		

**WHITE VARNISHED ALUMINIUM thermo packed**  
bar length 2 lm - pack. 10 Pcs - 20 lm

Article	L mm		
PIB 102C	10		
PIB 152C	15		
PIB 202C	20		
PIB 252C	25		
PIB 302C	30		
PIB 402C	40		

On demand are available 1 lm bars.

PI... 102C



PI... 122C



PI... 152C



PI... 202C



PI... 252C



PI... 302C



PI... 402C



## COLOURS



# FLAT

NATURAL, POLISHED AND BRUSHED BRASS



**NATURAL BRASS thermo packed**  
bar length 2 lm - pack. 10 Pcs - 20 lm

Article	L mm		
PION 102C	10		
PION 202C	20		

**POLISHED BRASS thermo packed**  
bar length 2 lm - pack. 10 Pcs 20 lm

Article	L mm		
PIOL 102C	10		
PIOL 202C	20		

PI... 102C



PI... 202C



**BRUSHED BRASS thermo packed**  
bar length 2 lm - pack. 20 Pcs - 20 lm

Article	L mm		
PIOS 102C	10		
PIOS 202C	20		

## COLOURS

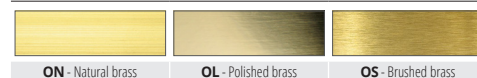

# EMPTY ROUND TUBE

ANODIZED GOLD AND SILVER ALUMINIUM  
POLISHED CHROME ALUMINIUM

TV... 061C TV... 081C TV... 101C TV... 121C

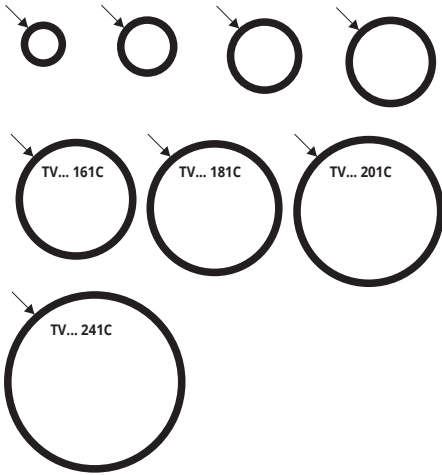

**ANODIZED GOLD AND SILVER ALUMINIUM thermo packed**  
thick 1 mm - bar length 2 lm - pack. 10 Pcs - 20 lm

Article	Ø mm ext.		
TV... 061C	6		
TV... 081C	8		
TV... 101C	10		
TV... 121C	12		
TV... 161C	16		
TV... 181C	18		
TV... 201C	20		
TV... 241C	24		

Available in the finishes: AO - AA.  
The code of the selected colour must be added to the article code.  
E.g.: TV... 122C (chosen finish anodized gold) TVAO 122C.

**POLISHED CHROME ALUMINIUM thermo packed**  
thick 1 mm - bar length 2 lm - pack. 10 Pcs - 20 lm

Article	Ø mm ext.		
TVBC 081C	8		
TVBC 101C	10		
TVBC 121C	12		
TVBC 161C	16		
TVBC 181C	18		
TVBC 201C	20		
TVBC 241C	24		



## COLOURS



On demand are available 1 lm bars.

# FULL ROUND TUBE

ANODIZED GOLD AND SILVER ALUMINIUM  
POLISHED CHROME ALUMINIUM

TP... 06C TP... 08C TP... 10C



**ANODIZED GOLD AND SILVER ALUMINIUM thermo packed**  
bar length 2 lm - pack. 10 Pcs - 20 lm

Article	Ø mm ext.		
TP... 06C	6		
TP... 08C	8		
TP... 10C	10		

Available in the finishes: AO - AA.  
The code of the selected colour must be added to the article code.  
E.g.: TP... 122C (chosen finish anodized gold) TPAO 122C.

**POLISHED CHROME ALUMINIUM thermo packed**  
bar length 2 lm - pack. 10 Pcs - 20 lm

Article	Ø mm ext.		
TPBC 06C	6		
TPBC 08C	8		
TPBC 10C	10		

On demand are available 1 lm bars.

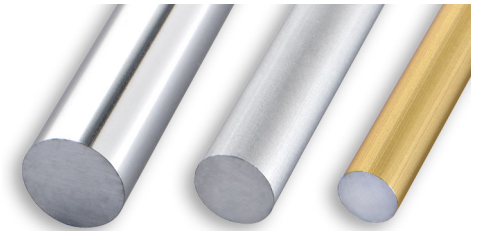

## COLOURS

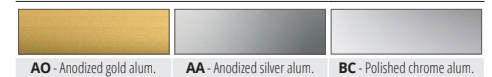

# FULL SQUARE TUBE

ANODIZED GOLD AND SILVER ALUMINIUM

**ANODIZED GOLD AND SILVER ALUMINIUM thermo packed**  
bar length 2 lm - pack. 10 Pcs - 20 lm

Article	L x H mm		
TQP... 08C	8 x 8		
TQP... 10C	10 x 10		

Available in the finishes: AO - AA. The code of the selected colour must be added to the article code. E.g.: TQP... 08C (chosen finish anodized gold) TQPAO 08C.

On demand are available 1 lm bars.

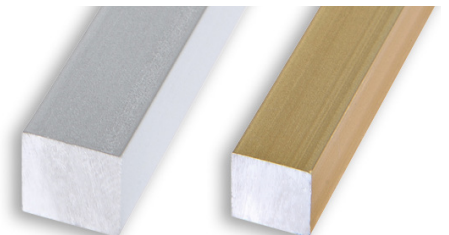

## COLOURS



\* = Production on demand with minimum quantity of 100 pcs. Production delay 4/5 weeks. Price to be agreed

# EMPTY SQUARE TUBE

ANODIZED GOLD AND SILVER ALUMINIUM  
POLISHED CHROME ALUMINIUM

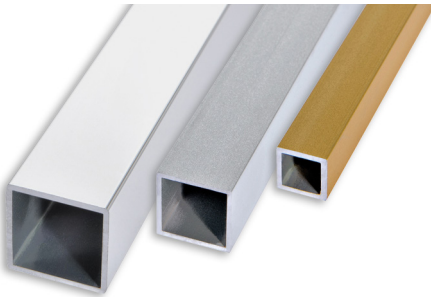

**ANODIZED GOLD AND SILVER ALUMINIUM thermo packed**  
bar length 2 lm - pack. 10 Pcs - 20 lm

Article	L x H mm
TQV... 10C	10 x 10
TQV... 15C	15 x 15
TQV... 20C	20 x 20

Available in the finishes: AO - AA.  
The code of the selected colour must be added to the article code.  
E.g.: TQV... 10C (chosen finish anodized gold) TQVAO 10C.

**POLISHED CHROME ALUMINIUM thermo packed**  
bar length 2 lm - pack. 10 Pcs - 20 lm

Article	L x H mm
TQVBC 10C	10 x 10
TQVBC 15C	15 x 15
TQVBC 20C	20 x 20

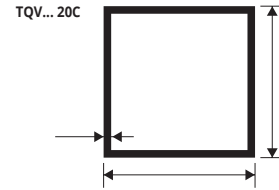
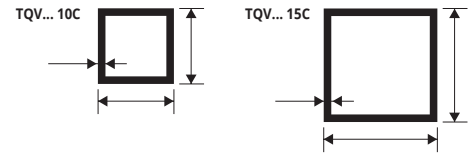

## COLOURS



On demand are available 1 lm bars.

# EMPTY RECTANGULAR TUBE

ANODIZED GOLD AND SILVER, POLISHED CHROME  
AND WHITE VARNISHED ALUMINIUM

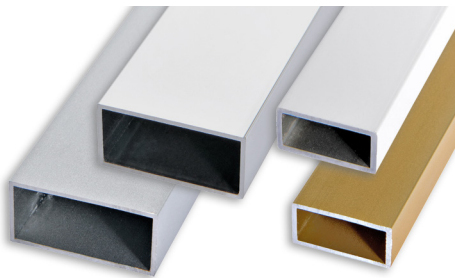

**ANODIZED GOLD AND SILVER ALUMINIUM thermo packed**  
bar length 2 lm - pack. 10 Pcs - 20 lm

Article	L x H mm
TR... 2010C	20 x 10
TR... 3015C	30 x 15

Available in the finishes: AO - AA.  
The code of the selected colour must be added to the article code.  
E.g.: TR... 2010C (chosen finish anodized gold) TRA0 2010C.

**POLISHED CHROME ALUMINIUM thermo packed**  
bar length 2 lm - pack. 10 Pcs - 20 lm

Article	L x H mm
TRBC 2010C	20 x 10
TRBC 3015C	30 x 15

**WHITE VARNISHED ALUMINIUM thermo packed**  
bar length 2 lm - pack. 10 Pcs - 20 lm

Article	L x H mm
TRB 2010C	20 x 10

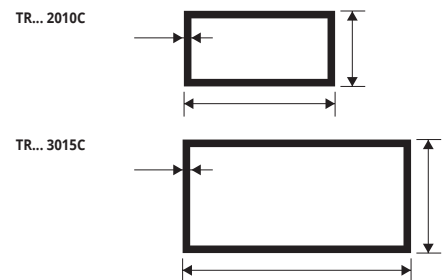

On demand are available 1 lm bars.

# CURVE PROFILE

ANODIZED GOLD AND SILVER, POLISHED CHROME  
AND WHITE VARNISHED ALUMINIUM

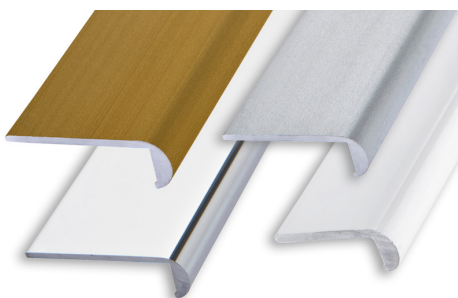

**ANODIZED GOLD AND SILVER ALUMINIUM thermo packed**  
thick 1 mm - bar length 2 lm - pack. 10 Pcs - 20 lm

Article	L mm
UG... 181C	18
UG... 221C	22
UG... 251C	25

Available in the finishes: AO - AA.  
The code of the selected colour must be added to the article code.  
E.g.: UG... 181C (chosen finish anodized gold) UGA0 181C.

**POLISHED CHROME ALUMINIUM thermo packed**  
thick 1 mm - bar length 2 lm - pack. 10 Pcs - 20 lm

Article	L mm
UGBC 181C	18
UGBC 221C	22
UGBC 251C	25

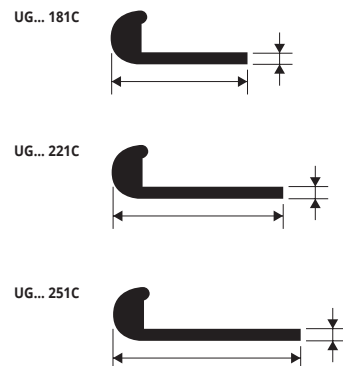

## COLOURS



**WHITE VARNISHED ALUMINIUM thermo packed**  
thick 1 mm - bar length 2 lm - pack. 10 Pcs - 20 lm

Article	L mm
UGB 181C	18

On demand are available 1 lm bars.



# PROFILE "T FORM"

ANODIZED GOLD AND SILVER ALUMINIUM  
POLISHED CHROME ALUMINIUM

T... 1515C

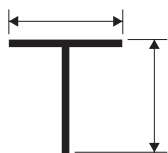

T... 2525C

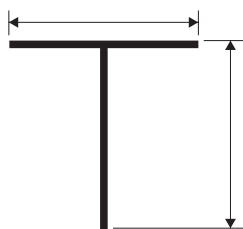

**ANODIZED GOLD AND SILVER ALUMINIUM thermo packed**  
thick 1 mm - bar length 2 lm - pack. 10 Pcs - 20 lm

Article	L x H mm		
T... 1515C	15 x 15		
T... 2525C	25 x 25		

Available in the finishes: AO - AA.  
The code of the selected colour must be added to the article code.  
E.g.: T... 1515C (chosen finish anodized gold) TAO 1515C.

**POLISHED CHROME ALUMINIUM thermo packed**  
thick 1 mm - bar length 2 lm - pack. 10 Pcs - 20 lm

Article	L x H mm		
TBC 1515C	15 x 15		
TBC 2525C	25 x 25		

On demand are available 1 lm bars.

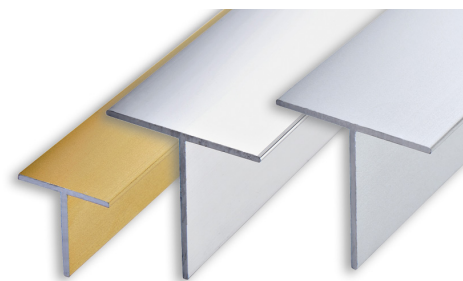

## COLOURS



# CURTAINBALANCE

ANODIZED SILVER AND WHITE VARNISHED ALUMINIUM

CTAA 304C  
CTB 304C



CTAA 404C  
CTB 404C



**ANODIZED SILVER ALUMINIUM thermo packed**  
thick 4 mm - bar length 2 lm - pack. 10 Pcs - 20 lm

Article	L mm		
CTAA 304C	30		
CTAA 404C	40		

**WHITE VARNISHED ALUMINIUM thermo packed**  
thick 4 mm - bar length 2 lm - pack. 10 Pcs - 20 lm

Article	L mm		
CTB 304C	30		
CTB 404C	40		

On demand are available 1 lm bars.

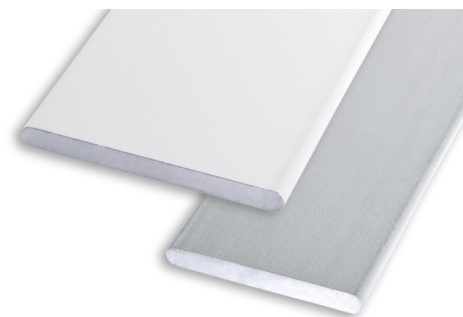

## COLOURS

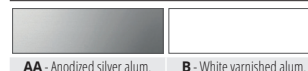



PIF 153  
PIF 203  
PIF 253  
PIF 403



**FLAT IRON**

thick 3 mm - bar length 2 lm - pack. 10 Pcs - 20 lm

Article	L mm		
PIF 153	15		
PIF 203	20		
PIF 253	25		
PIF 403	40		

items not for sell individually.

AGF 203  
AGF 303  
AGF 403

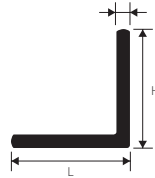

**CORNER EQUAL SIDES IRON**

thick 3 mm - bar length 2 lm - pack. 10 Pcs - 20 lm

Article	L x H mm		
AGF 203	20 x 20		
AGF 303	30 x 30		
AGF 403	40 x 40		

items not for sell individually.

ALF 3020  
ALF 4020

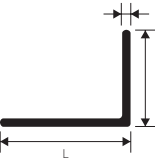

**CORNER "L-FORM" IRON**

thick 2 mm - bar length 2 lm - pack. 10 Pcs - 20 lm

Article	L x H mm		
ALF 3020	30 x 20		
ALF 4020	40 x 20		

items not for sell individually.

TVF 12  
TVF 16  
TVF 20  
TVF 25

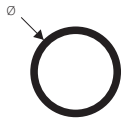

**EMPTY ROUND TUBE IRON**

bar length 2 lm - pack. 10 Pcs - 20 lm

Article	Ø mm ext.		
TVF 12	12		
TVF 16	16		
TVF 20	20		
TVF 25	25		

items not for sell individually.

TPF 10  
TPF 12

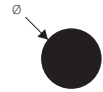

**FULL ROUND TUBE IRON**

bar length 2 lm - pack. 10 Pcs - 20 lm

Article	Ø mm ext.		
TPF 10	10		
TPF 12	12		

items not for sell individually.

TQPF 08  
TQPF 10  
TQPF 12  
TQPF 14

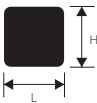

**FULL SQUARE TUBE IRON**

bar length 2 lm - pack. 10 Pcs - 20 lm

Article	L x H mm		
TQPF 08	8 x 8		
TQPF 10	10 x 10		
TQPF 12	12 x 12		
TQPF 14	14 x 14		

items not for sell individually.

TQVF 20  
TQVF 25  
TQVF 30  
TQVF 40

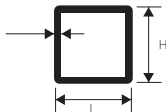

**EMPTY SQUARE TUBE IRON**

bar length 2 lm - pack. 10 Pcs - 20 lm

Article	L x H mm		
TQVF 20	20 x 20		
TQVF 25	25 x 25		
TQVF 30	30 x 30		
TQVF 40	40 x 40		

items not for sell individually.

TRF 3020  
TRF 4020

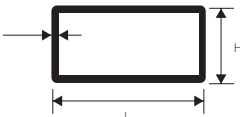

**EMPTY RECTANGULAR TUBE IRON**

bar length 2 lm - pack. 10 Pcs - 20 lm

Article	L x H mm		
TRF 3020	30 x 20		
TRF 4020	40 x 20		

items not for sell individually.

**PROFILE "T-FORM" IRON**

bar length 2 lm - pack. 10 Pcs - 20 lm

Article	L x H mm		
TF 20	20 x 20		

items not for sell individually.

**CANAL "U FORM" IRON**

bar length 2 lm - pack. 10 Pcs - 20 lm

Article	L x H mm		
CUF 1515	15 x 15		
CUF 3020	30 x 20		

items not for sell individually.

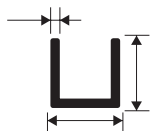
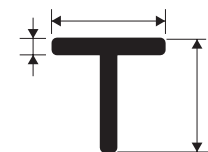



An interpretation of:

**One World Trade Center, David Childs , NEW YORK CITY (USA), 2014**





PRODUCTS FOR LAYING

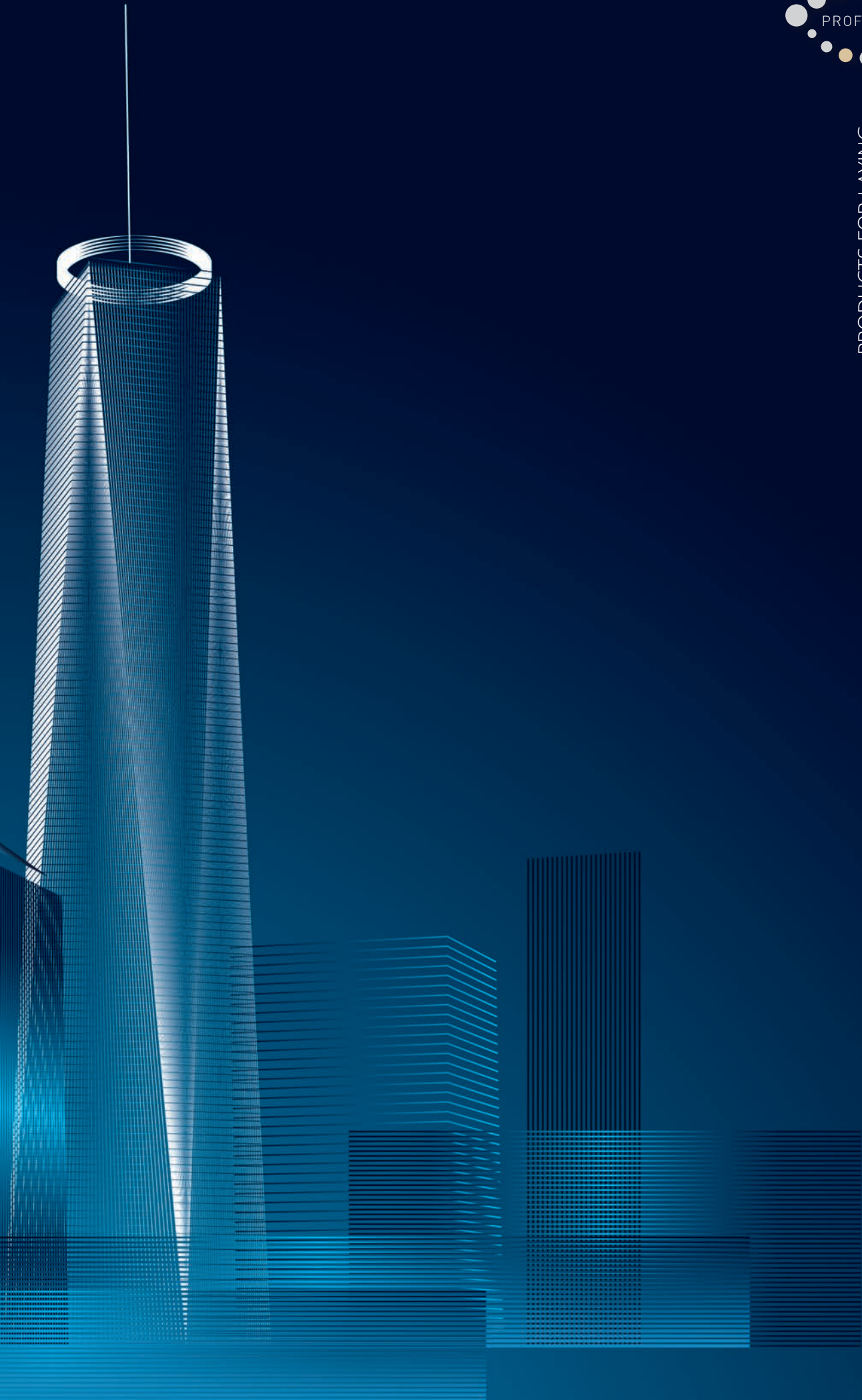

# TRANSPARENCY FOR A PERFECT LAYING.



**PATENTED**

**Completely visible joint**

$H \geq 50 \text{ mm}$

$H \geq 50 \text{ mm}$

**The only one with 2 elements**

**Save 3 pieces on intersections**

**PATENTED**

- 1407796
- 1424326
- 2,790,556
- EP 2573296 B1
- EP 2952652 B1
- EP 3511484 B1
- US 8,635,815 B2
- US 9,328,522 B2
- US 10,760,284
- 2019000015848
- 20201800000069410
- Patents Pending

**PROGRESS®**  
FILLER  
**PROBAND**



Kicking the clip in the direction of the joint.

## ADVANTAGES

- 1 Simple and quick to lay with **only 2 elements: leveler & cap**. No need for expensive hand tools.
- 2 The only worldwide leveling system with multiple size levelers (2,3 and 5 mm). Built in spacers are available to accommodate "+" intersections as well as "T" joints **with a single leveler saving up to 3 pieces per joint**.
- 3 The only System with only two elements (**leveler & cap**) capable of leveling 3 to 20 mm floors and wall coverings with 1/2/3/5 mm available joints, and from 20 to 40 mm with 8 mm joint. Simply flip the cap over to work with various thicknesses.
- 4 It guarantees a minimum joint of 1 mm, maximum 5 mm.
- 5 Vertical compression reduces movement and widening of joints.
- 6 The thin base of the leveler allows for easy placement without mortar accumulation.
- 7 The shaped hole in the middle of the cross and T-shaped levelers allow a perfect control of the tiles lining up. Moreover the holes on their base enable a perfect anchoring between adhesive and tile.



# Proleveling System

## DESCRIPTION

**Proleveling System** is a revolutionary and innovative leveling system when laying medium and large materials with a thickness between 3 and 40 mm.

The patented system is made of 2 elements:

- A leveling base (1-2-3-5 mm size) with spaced notches that allow spacing/separating/ joining floors of any type and material in a way that is: linear, cross and half cross with joints to be chosen between 1mm, 2 mm, 3 mm and 5 mm.
- The threaded stem is attached perpendicularly to the base in a way that allows for easy adjustment with turns of the cap during installation. Removal of the cap and Stem after the materials are set is made easy with strategically placed breakage points that release with either increased pressure by turning the cap or by kicking the cap in the direction of the joint.

One cap fits all threaded stems and can be reused an infinite amount of times for big cost savings.

The new PPLS (patented) system assists in the reduction or elimination of ledging and lippage in the installation of various types of materials that are applied to floors or walls with mortar including: Large Format Tile, Natural Stone, Thin Profile Tile and many others.

## LAYING SYSTEM

- Choose the desired type of Leveler (spacers) based on the requested joints and joining:
  - 1 mm Linear, Cross and Half Cross Version
  - 2 mm Linear, Cross and Half Cross Version
  - 3 mm Linear, Cross and Half Cross Version
  - 5 mm Linear, Cross and Half Cross Version
- Apply the thinset or mortar on a level base with the proper notched trowel as called out in the setting materials manufacturer's installation instructions.
- During the application of the tile or other materials, position the base of the chosen Leveler under the edge of the tile at the appropriate joint location and continue laying in sequence.
- Attach the cap to the threaded stem by rotating it clockwise. Level the joint by rotating the cap using the minimum amount of pressure needed.
- Once the setting materials have become solid and the floor or wall is ready for grout: kick the cap in the direction of the joint to detach connection points between base and stem.

Remover: Fixed on a drill allows to remove levelers from caps.



By turning the cap it is possible to level a thickness of up to 40 mm with an 8 mm joint.

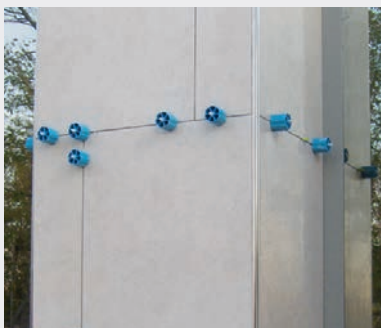

T-shaped leveler installation.



Linear leveler installation.



# Proleveling System

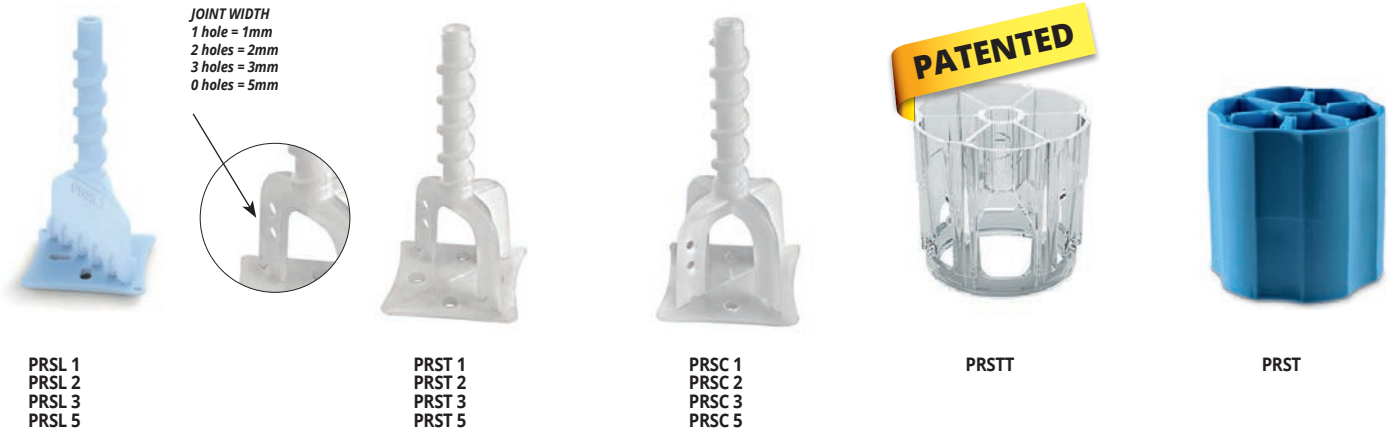

## LINEAR LEVELER PROLEVELING SYSTEM

Article	thick mm	Pcs/Pack.	Pcs/box
PRSL 1	1	100	4000
PRSL 2	2	100	4000
PRSL 3	3	100	4000
PRSL 5	5	100	4000

## "T" LEVELER PROLEVELING SYSTEM

Article	thick mm	Pcs/Pack.	Pcs/box
PRST 1	1	100	3000
PRST 2	2	100	3000
PRST 3	3	100	3000
PRST 5	5	100	3000

## CROSS LEVELER PROLEVELING SYSTEM

Article	thick mm	Pcs/Pack.	Pcs/box
PRSC 1	1	100	3000
PRSC 2	2	100	3000
PRSC 3	3	100	3000
PRSC 5	5	100	3000

## PROLEVELING SYSTEM REMOVER FOR LEVELER

Article	Pcs/Pack.	Pcs/box
PRSSV	50	1300



PRSSV

## ROTATING POMMEL CAP FOR LEVELER PROLEVELING SYSTEM

Article	Pcs/Pack.	Pcs/box
PRSTT	50	1000
PRST	50	1000

## PROTECTION CAP FOR PROLEVELING SYSTEM

Article	Pcs/Pack.	Pcs/box
PRSPC	50	3000



It protects the marble and natural stones surface from scratches that could be provoked by the cap during the floor levelling.

Tiles cm x cm	30 X 30	40 X 40	45 X 45	50 X 50	60 X 60	80 X 80	90 X 90	120 X 120
U. / MQ (Type of leveler)*	11 (only +)	6 (only +)	5 (only +)	4 (only +)	3 (only +)	5 (2+, 3L)	5 (2+, 3L)	3 (1+, 2L)

\* + = cross leveler, L = linear leveler, T = "T" shape leveler

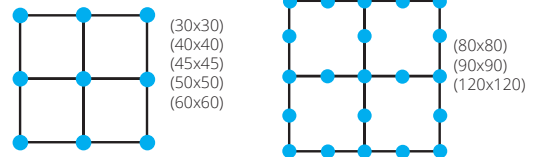

Tiles cm x cm	30 X 60	40 X 80	45 X 90	120 X 30	100 X 50	120 X 60
U. / MQ (Type of leveler)*	6 (only +)	6 (3+, 3L)	6 (3+, 3L)	6 (3+, 3L)	4 (2+, 2L)	4 (2+, 2L)

\* + = cross leveler, L = linear leveler, T = "T" shape leveler

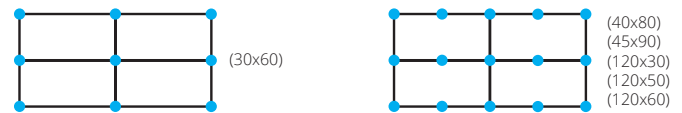

Tiles cm x cm	10 X 100	12 X 100	15 X 100	20 X 100	10 X 120	12 X 120	15 X 120	20 X 120	10 X 80	12 X 80	15 X 80	20 X 80	40 x 80	45 x 90	100 x 50	120 x 60
U. / MQ (Type of leveler)*	20 (only T)	17 (only T)	14 (only T)	10 (only T)	17 (only T)	14 (only T)	11 (only T)	9 (only T)	25 (only T)	21 (only T)	17 (only T)	13 (only T)	6 (only T)	5 (only T)	4 (only T)	4 (only T)

\* + = cross leveler, L = linear leveler, T = "T" shape leveler

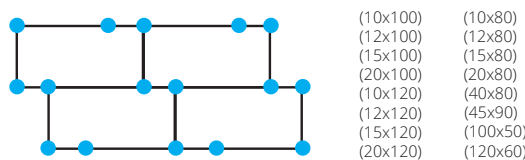



# Proleveling Wedge System

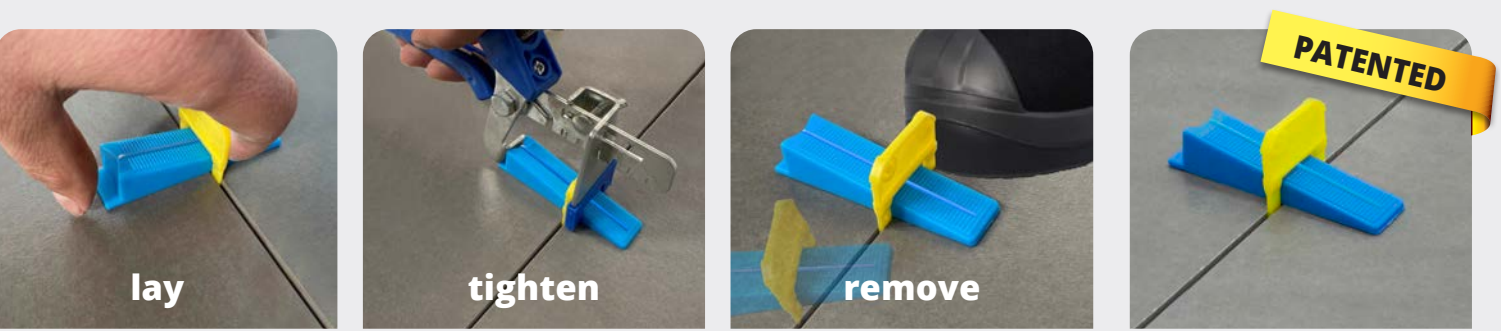

## ADVANTAGES

- Complies with the legislation:** Thanks to the join of the stems directly on the base, after the removal there are no components between the joints;
- Ergonomic wedge:** The concave part of the wedge allows greater ease in insertion;
- Easier to insert:** Improved base with the new eye shape that ensures better and more effective insertion under the tile;

## PROLEVELING WEDGE SYSTEM

Leveling system for tiles composed of 3 elements: wedge, leveler and plier. The levelers are available for grout lines of 1/1.5/2 and 3 mm and are suitable for tiles with thickness from 3 to 12 mm and from 12 to 20 mm. The wedge, with a length of 90 mm and a width of 22 mm, is inserted during the laying inside the leveler and thanks to the plier we get a complete flatness between adjacent tiles. When the adhesive is hardened, kick the wedges and the protruding part of the levelers along the grout line.

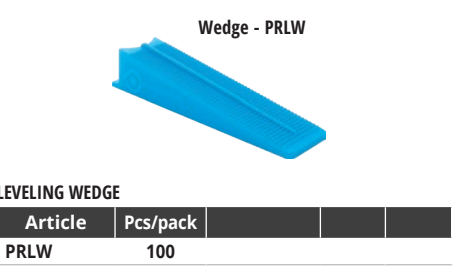

PROLEVELING WEDGE SYSTEM - LINEAR LEVELERS					
Article	h. mm	Thick. mm	Pcs/pack	Pcs/Box	
PRLW 1	3-12	1	200	3000	
PRLW 15	3-12	1,5	200	3000	
PRLW 2	3-12	2	200	3000	
PRLW 3	3-12	3	200	3000	
PRLW 120	12-20	1,5	100	2500	
PRLW 220	12-20	2	100	2500	

INDICATIVE CONSUMPTIONS FOR A SURFACE OF 10 M <sup>2</sup>																			
X cm	10	15	20	25	30	40	45	50	55	60	75	80	90	100					
10	1980																		
15	1317	876																	
20	495	328	490																
25	396	263	391	312															
30	660	438	488	389	431														
35	495	328	365	291	322	240													
40	440	292	324	258	285	213	189												
45	396	263	291	232	256	191	169	152											
50	360	239	264	211	232	173	154	138	125										
55	330	219	242	193	212	158	141	126	114	105									
75	396	263	258	206	212	158	140	126	114	104	99								
80	371	246	241	192	198	148	131	117	107	97	93	87							
90	330	219	214	171	176	131	116	104	94	86	82	77	68						
100	297	197	192	153	157	117	104	93	84	77	73	68	61	54					
120	330	219	200	160	157	117	104	93	84	77	71	66	59	52	49				
150	330	219	192	153	146	109	96	86	78	71	64	60	53	47	44	38			
180	330	219	186	149	139	103	91	82	74	68	60	56	49	44	40	34	31		
200	347	230	192	153	140	104	92	83	75	68	59	55	49	44	39	33	30	28	
	10	15	20	25	30	40	45	50	55	60	75	80	90	100	120	150	180	200	Y cm

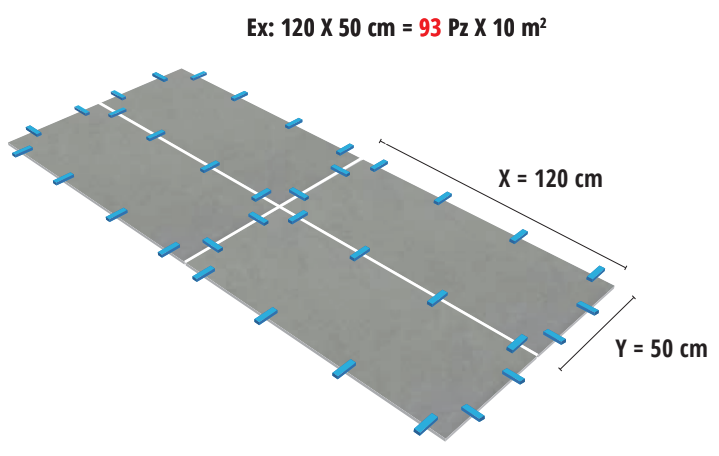

**MULTISPACER** Removable and reusable spacer for joints of tiled floors and walls. Its little tabs and open shape allows various uses with a perfect joint and view of the junctions among tiles during the laying.

# MULTISPACER

**PATENTED**



### MULTISPACER

Article	Thick. mm	Pcs/pack	Pcs/Box
MSP 1	1	100	2500
MSP 2	2	100	2500
MSP 3	3	100	2500
MSP 5	5	100	2500



The **CROSS-SHAPED** and **T-SHAPED SPACERS** are perforated, weatherproof and made in top quality material with choice of colour. They are used to provide regular gaps in floors and coverings and thanks to the anti-floating perforations remain in the correct laying position. Available in every required thickness 1 - 2 - 3 - 4 - 5 - 7 - 10 mm. Levelling wedges are also available for compensating differences in level that emerge during laying. The **Y-SHAPED SPACERS** have to be used to separate hexagonal tiles in floors and walls. Available in thickness 2 and 3 mm.

## SPACERS LEVELLING WEDGES

### PERFORATED SPACERS CROSS-SHAPED boxes with bags of 250 Pcs each

Article	Thick. mm	Pcs/Box
RC 1	1	20.000
RC 2	2	15.000
RC 3	3	15.000
RC 4	4	15.000
RC 5	5	15.000
RC 7	7	10.000
RC 10	10	5.000

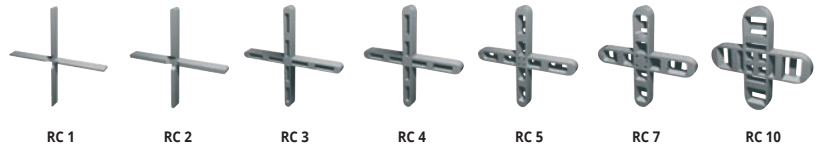

### PERFORATED SPACERS T-SHAPED boxes with bags of 250 Pcs each

Article	Thick. mm	Pcs/Box
RT 1	1	20.000
RT 2	2	15.000
RT 3	3	15.000
RT 4	4	15.000
RT 5	5	15.000
RT 7	7	10.000
RT 10	10	5.000



### Y-SHAPED SPACERS FOR HEXAGONAL TILES boxes with bags of 250 Pcs each

Article	Thick. mm	Pcs/Box
RY 2	2	10.000
RY 3	3	10.000

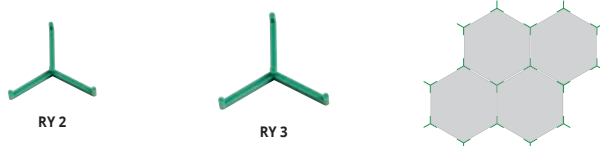

### LEVELLING WEDGES boxes with bags of 500 Pcs

Article	Thick. mm	Pcs/Box
PCU 5	0 - 5	10.000

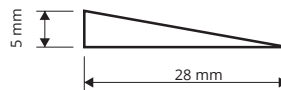

### SPACERS / SQ.M

TILE FORMAT cm x cm	60 x 60	60 x 30	40 x 40	40 x 30	40 x 20	33 x 33	30 x 30	30 x 20	25 x 25	20 x 20	15 x 15	13 x 26	13 x 13	10 x 20	10 x 10
CROSS-SHAPED SPACERS No. / Sq.m	3	6	7	9	12	9	11	17	16	25	44	30	60	50	100
T-SHAPED SPACERS No. / Sq.m	6	12	14	18	24	18	22	34	32	50	88	60	120	100	200

### Y-SHAPED SPACERS

2 spacers for each tile multiplied by the amount of tiles per square meter



# PROSUPPORT TUBE SYSTEM

ADJUSTABLE AND MODULAR SUPPORTS SYSTEM FOR OUTDOOR FLOATING FLOORS

**PROSUPPORT TUBE SYSTEM** is an adjustable and modular supports system for outdoor floating floors from the height of 29 mm to 1000 mm. The system is composed of 1 base, 2 screws, 1 flange, 2 heads and several pvc pipes to obtain the requested height. Both heads, according to the screw, can be fix or self-levelling.

**PATENTED**

## PROSUPPORT TUBE SYSTEM KIT HEIGHTS

FULL KIT - Pack. 40 Pcs. - Items not for sale individually. Minimum order one pack.

**A:** SUPPORT'S HEIGHT WITH SELF-LEVELLING INSTALLATION  
**B:** SUPPORT'S HEIGHT WITH FIX SIDE INSTALLATION  
**T:** THICKNESS OF THE SPACER FLAP



FULL KIT CODE	
PST3454/4 T = 4 mm	PST3454/2 T = 2 mm
€/Pc.	
€/Pack.	

FULL KIT CODE	
PST5474/4 T = 4 mm	PST5474/2 T = 2 mm
€/Pc.	
€/Pack.	

FULL KIT CODE	
PST7494/4 T = 4 mm	PST7494/2 T = 2 mm
€/Pc.	
€/Pack.	

FULL KIT CODE	
PST94114/4 T = 4 mm	PST94114/2 T = 2 mm
€/Pc.	
€/Pack.	

FULL KIT CODE	
PST114134/4 T = 4 mm	PST114134/2 T = 2 mm
€/Pc.	
€/Pack.	

FULL KIT CODE	
PST134154/4 T = 4 mm	PST134154/2 T = 2 mm
€/Pc.	
€/Pack.	

FULL KIT CODE	
PST154174/4 T = 4 mm	PST154174/2 T = 2 mm
€/Pc.	
€/Pack.	

FULL KIT CODE	
PST174194/4 T = 4 mm	PST174194/2 T = 2 mm
€/Pc.	
€/Pack.	

FULL KIT CODE	
PST194214/4 T = 4 mm	PST194214/2 T = 2 mm
€/Pc.	
€/Pack.	

### HEIGHTS GREATER THAN 209 mm

H (mm) SELF-LEVELLING HEAD (A)	H (mm) FIX HEAD (B)
214/234	209/229
234/254	229/249
254/374	249/269
274/294	269/289
294/314	289/309
314/334	309/329
334/354	329/349
354/374	349/369
374/394	369/389
394/414	389/409
414/434	409/429
434/454	429/449
454/474	449/469
474/494	469/489
494/514	489/509

Choose the kit according to the desired tile joint (T)

PST3454/4 T = 4 mm	PST3454/2 T = 2 mm
-----------------------	-----------------------



PST3454/...

PIPE	FLANGE
PSTT 175	PSTGH 02
PSTT 195	
PSTT 215	
PSTT 235	
PSTT 255	
PSTT 275	
PSTT 295	
PSTT 315	
PSTT 335	
PSTT 355	
PSTT 375	
PSTT 395	
PSTT 415	
PSTT 435	
PSTT 455	



PSTGH 02



## SELF-LEVELING HEAD MODE

Self-levelling head mode  
Max height 1000 mm with max slope of 5%.

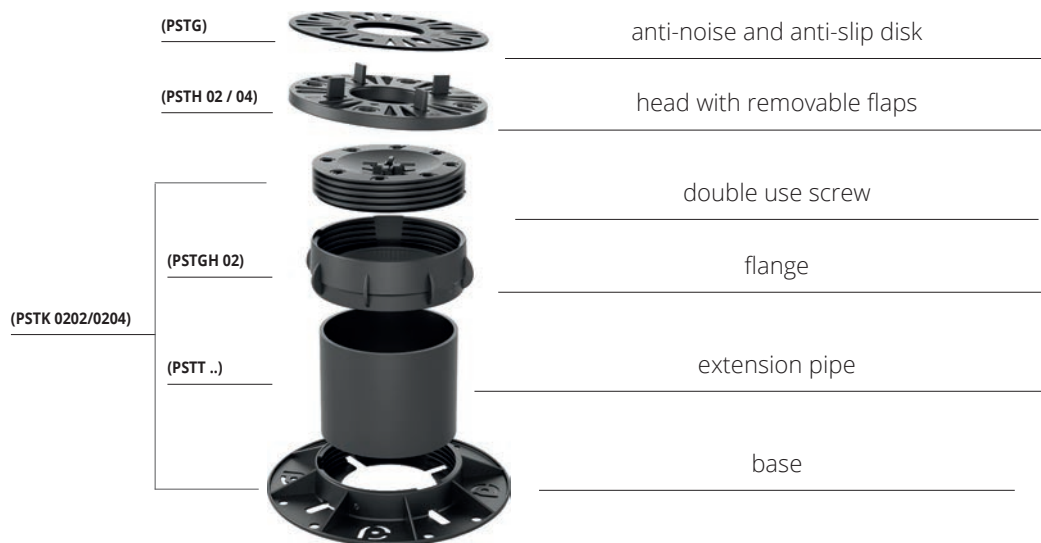

## FIXED HEAD MODE

Fixed head mode  
Max height 1000 mm

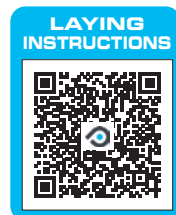

## PROSUPPORT TUBE SYSTEM COMPONENTS

BASE + SCREW 20/40 mm  
polypropylene - pack. 40 Pcs. (PSTK 0202) - pack. 20 Pcs. (PSTK 0204)

Article	Thickness (mm)	kit / pack.
PSTK 0202	20	40
PSTK 0204	40	20

Items not for sale individually. Minimum order one pack.

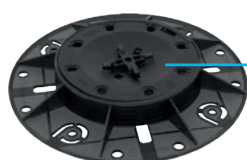

PSTK 0202

BASE + SCREW 20 mm



PSTK 0204

BASE + SCREW 40 mm

HEAD with removable flaps 2/4 mm  
polypropylene - pack. 40 Pcs.

Article	flap Thk (mm)	kit/pack.
PSTH 02	2	40
PSTH 04	4	40

Items not for sale individually. Minimum order one pack.



PSTH 02 / PSTH 04

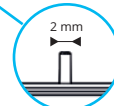

FLAP THICKNESS 2 mm - PSTH 02

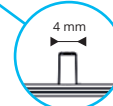

FLAP THICKNESS 4 mm - PSTH 04

FLANGE 40 mm  
polypropylene - pack. 40 pcs

Article	H (mm)	Pc/pack.
PSTGH 02	40	40

Connection nut with a lower side of 110 mm inner diameter, where the pipe of different heights should be inserted, and one side with thread where the regulation screws should be inserted.

Items not for sale individually. Minimum order one pack.



PSTGH 02

ANTI-NOISE AND ANTI-SLIP DISK  
rubber - H 1,5 mm - Ø 150 - pack. 120 pcs

Article	H / Ø mm	Pc/pack.
PSTG	H 1,5 - Ø150	120

The non-slip rubber disk to be used with the heads of PROSUPPORT TUBE SYSTEM reduces noises till 25 dB.

Items not for sale individually. Minimum order one pack.



PSTG

PRE-CUT EXTENSION PIPE - outer diameter Ø110 mm Thickness 4 mm - polyethylene polypropylene - pack. 40 Pcs.

Article	H (mm)	Pc/pack.
PSTT 35	35	40
PSTT 55	55	40
PSTT 75	75	40
PSTT 95	95	40
PSTT 115	115	40
PSTT 135	135	40
PSTT 155	155	40

Items not for sale individually. Minimum order one pack.



PSTT...

FULL LENGHT EXTENSION PIPE - outer diameter Ø110 mm Thickness 4 mm - polyethylene or polypropylene - pallet 43 Pcs.

Article	H (m)	ml/pallet.
PSTT 2700	2,7	116

Items not for sale individually. Minimum order one pallet.

UPON REQUEST IT IS POSSIBLE TO HAVE HEIGHTS TILL 1000 MM USING PIPES FROM 155 TILL 955. For information and installation instructions ask for the technical data sheet. Price to be agreed. Production delay 4/5 weeks.

PSTT 2700



270 cm



# PERIMETER SPACER

Perimeter spacer of stainless steel AISI 316L / 1.4404 - V4A for laying outdoor floating floors. The profile makes a 5 mm wide perimeter gap, for the outflow of rainwater; moreover, thanks to the rounded fin with which is provided, it does not damage the waterproofing sheath. The slit width of 0.5 cm and the length of 18 cm ensure a perfect anchorage of the spacer with the heads of the Prosupport System.

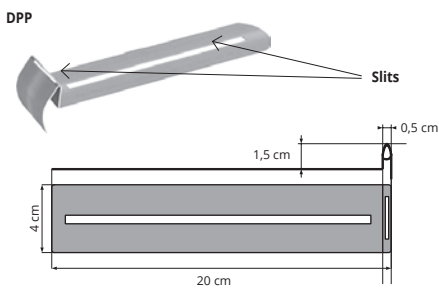

**PERIMETER SPACER PROSUPPORT SYSTEM**  
Stainless steel AISI 316L / 1.4404 - V4A - pack. 40 Pcs

Article		
DPP		



# PROSUPPORT TUBE SYSTEM OPTIONAL

**ADJUSTING KEY (only for head PSTH 04)**

Article		
PSTAK		



**ADJUSTABLE SPACER TABS 4 mm polypropylene - Pack 80 pcs**

Article	L x H mm	Pcs/pack
PSTJ	80 x 20	80

Spacer tabs 80 mm long to be fixed on the self-levelling head, which allow the fixing of wooden, WPC and aluminium joists of max width 80 mm.



Items not for sale individually. Minimum order one pack.

**FIXING CLIP FOR TILES - WIND-PROOF**  
Pack 40 pairs

Article	L x H mm	pairs/pack
PSTWP	20 x 60	40

Fastening clip to fix the tiles and block the floor in case of strong wind. The clips must be inserted inside the cross joint or along the perimeter of the floor.



Items not for sale individually. Minimum order one pack.

**RUBBER DISK for laying on bituminous roof membrane**  
H 2 mm - Pack. 100 Pcs (box 100 pcs)

Article	H (mm)
LVGG 02	2

Rubber disc, 2 mm thick, to be applied under the support (SQG 15) to protect the bituminous membrane.



**SPACER FOR APPLICATION ON GRAVEL**  
Pack. 100 Pcs (box 100 pcs)

Article		
DILV		

Transparent plastic cross spacer for laying on gravel or irregular surfaces.

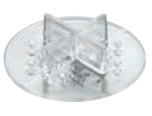

**PROSUPPORT PROFILE T & N** is a profile for the protection and finishing of the external edge of raised floors in ceramic, wood and composite materials. The vertical section of the profiles features a specially designed fins that create a dovetail cladding system. This dovetail cladding system allows for the adhesive used to fix the covering to also mechanically bond to the profiles. The profile is also available with a decorative edge of 2 cm height (PROSUPPORT PROFILE T).

# PROSUPPORT PROFILE T & N

VARNISHED ALUMINIUM  
NATURAL ALUMINIUM

**PATENTED**



**PROSUPPORT PROFILE T - VARNISHED ALUMINIUM**  
bar length 2,7 lm - pack. 20 Pcs - 54 lm

Article	L x H mm	h mm		
PSPRPT 20AL...	177,7x81,5	60		

#### COLOURS (EMBOSSED)

GF - Grey (7038)	A - Anthracite grey - (no RAL)

#### \* ON DEMAND (EMBOSSED)

BF - White (9010)	TF - Dark brown (8019)	C - Corten
EF - Beige		



**PROSUPPORT PROFILE N - NATURAL ALUMINIUM**  
bar length 2,7 lm - pack. 20 Pcs - 54 lm

Article	H mm	L		
PSPRP 15560AL	60	156,5		

#### COLOURS

AN - Natural aluminium

#### LAYING INSTRUCTIONS

1. Choose "PROSUPPORT PROFILE" desired model. 2. Cut "PROSUPPORT PROFILE" to the desired length and put on the supports and aligning. 3. Lay the floor by adjusting the height of the supports until completely leveling. 4. Cut the tiles of the correct size to close the perimeters of the floating floor. 5. Fix on the vertical surface of the profile the tiles using a suitable adhesive.

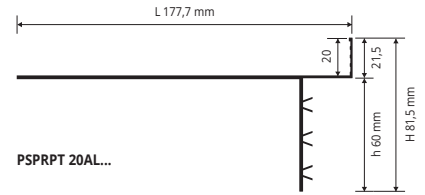

PSPRPT 20AL...

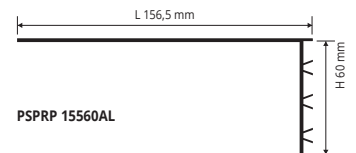
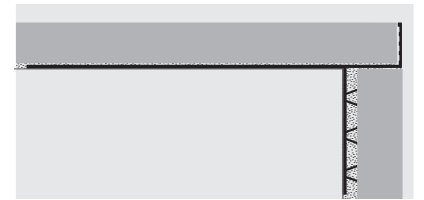

PSPRP 15560AL

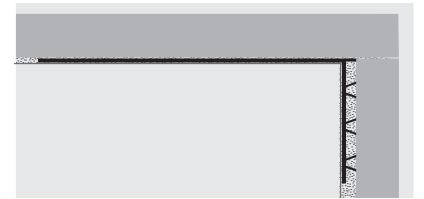

**PROSUPPORT SYSTEM A & B** Perimeter profile to protect and finish the outer edge of raised floors of different types, ceramic, wood, stone etc. The **PROSUPPORT PROFILE A** consists in an "L"-shaped horizontal flat base to insert and anchor above the **PROSUPPORT** Self-levelling head and a vertical visible part to insert in the vertical "L"-shaped element (as indicated in the drawing).

**Use:** Perimeter profile to protect and finish the outer edge of raised floors of different types, ceramic, wood, marble etc. The **PROSUPPORT PROFILE** consists in an "L"-shaped horizontal flat base to insert and anchor above the **PROSUPPORT** Self-levelling head and a vertical visible part to insert in the vertical "L"-shaped element (as indicated in the drawing)

# PROSUPPORT PROFILE A & B

VARNISHED ALUMINIUM,  
NATURAL ALUMINIUM



**PUNCHED AND PERFORATED PROSUPPORT A**  
**NATURAL ALUMINIUM** - length 2,7 lm - pack. 20 Pcs

Article	L x H		
BPPSAN 15015	150 X 15		
BPPSAN 15020	150 X 20		
BPPSAN 15025	150 X 25		

#### COLOURS

AN - Natural aluminium

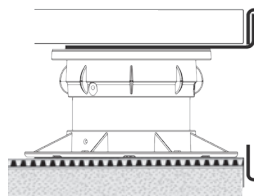

**TOP PROFILE PROSUPPORT B - VARNISHED ALUMINIUM**  
length 2,7 lm Pack 10 Pcs (PFPSAL...1060 Pack 20 Pcs)

Article	H1		
PFPSAL... 1060	60		
PFPSAL... 1080	80		
PFPSAL... 10100	100		

#### COLOURS (EMBOSSED)

GF - Grey (7038)	A - Anthracite grey - (no RAL)

#### \* ON DEMAND (EMBOSSED)

BF - White (9010)	TF - Dark brown (8019)	C - Corten
EF - Beige		

#### PROSUPPORT A

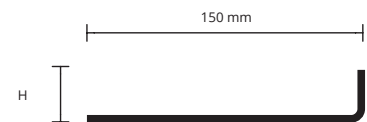

#### PROSUPPORT B

PFPSAL... 1060      PFPSAL... 1080      PFPSAL... 10100

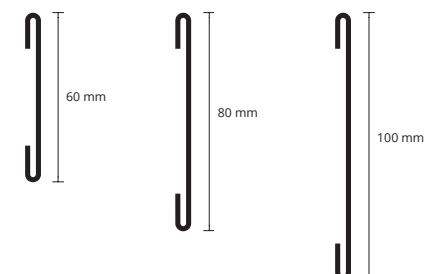

\* = Production on demand with minimum quantity of 100 pcs. Production delay 4/5 weeks. Price to be agreed



# PRORAIL SYSTEM

**PRORAIL SYSTEM** is a modular system composed of aluminium joists to lay floating floors of any size, to create steady and modular substructures together with PROSUPPORT TUBE and PROSUPPORT SLIM. The system consists of two aluminium joists, PRORAIL and PRORAIL RET, one fastening ring PRORAIL RING, two cross spacers with removable flaps PRORAIL SPACER and one anti-noise and anti-slip rubber PRORAIL RUBBER

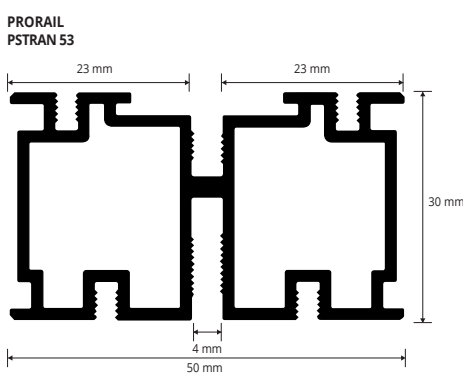

**PRORAIL - SHAPED JOIST**  
aluminium - Pack 10 Pc - Bar length 2,7 Lm

Article	L x H (mm)	Pc/Pack
PSTRAN 53	50 X 30	10



**PRORAIL RUBBER**  
Roll length 110 Lm

Article	L roll ml
PSTRI	110

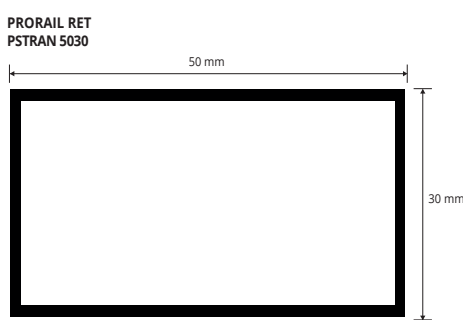

**PRORAIL RET - SMOOTH JOIST**  
aluminium - Pack 10 Pc - Bar length 2,7 ML

Article	L x H (mm)	Pc/Pack
PSTRAN 5030	50 X 30	10



**PRORAIL RING - JOIST FASTENING RING**  
polypropylene - Pack 40 Pc

Article	Ø mm	Pc/Pack
PSTRR	135	40

## PRORAIL SYSTEM LAYING PATTERN

- Material required for 1 qm of the below pattern:
- 3 pcs PROSUPPORT TUBE/PROSUPPORT TUBE SLIM
  - 3 pcs fastening rings PRORAIL RING
  - 2.7 Lm PRORAIL joist
  - 4 Lm PRORAIL RUBBER

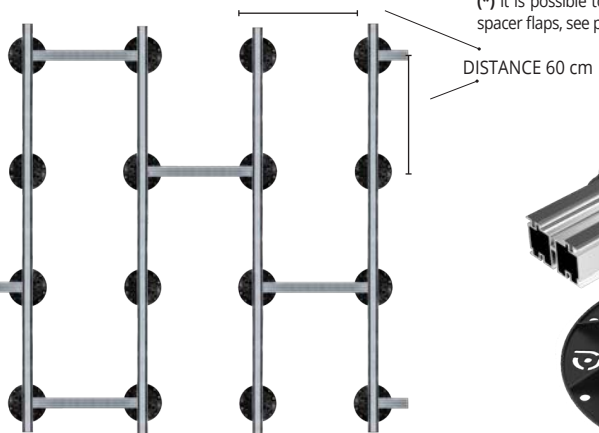

## TECHINCAL LAYING INSTRUCTIONS

1. Choose the support PROSUPPORT TUBE or PROSUPPORT SLIM of the required height;
2. Set the fastening ring PRORAIL RING on the supports;
3. Set the joist PRORAIL (\*) or the joist PRORAIL RET on the ring;
4. Insert the rubber PRORAIL RUBBER inside the grooves of the joist PRORAIL;
5. Set the cross spacers PRORAIL SPACER following the laying pattern; (\*) It is possible to fix the joist PRORAIL on the supports fixing it into the spacer flaps, see picture hereunder.



PRORAIL SPACER - PSTRS 02



PRORAIL SPACER - PSTRS 04

**PRORAIL SPACER - CROSS SPACER with removable flaps**  
polypropylene - Pack 100 Pc

Article	thickness (mm)	Pc/Pack
PSTRS 02	2	100
PSTRS 04	4	100

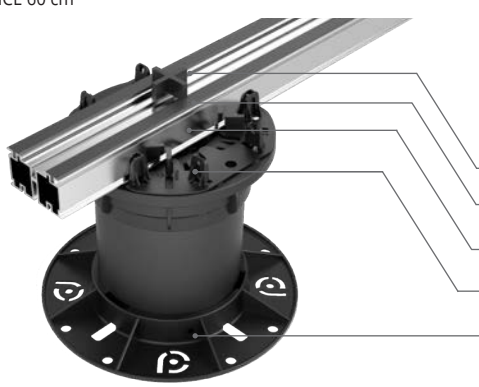

- PRORAIL SPACER - PSTRS 02/04
- PRORAIL RUBBER - PSTRI
- PRORAIL - PSTRAN 53
- PRORAIL RING - PSTRR
- PROSUPPORT TUBE

**FIXING WITH PRORAIL JOIST:**  
Prosupport tube/slim + Prorail + Prorail spacer + Prorail rubber



**FIXING WITH RING AND PRORAIL JOIST:**  
Prosupport tube/slim + Prorail ring + Prorail + Prorail spacer + Prorail rubber



**FIXING WITH RING AND PRORAIL RET SMOOTH JOIST :**  
Prosupport tube/slim + Prorail ring + Prorail ret

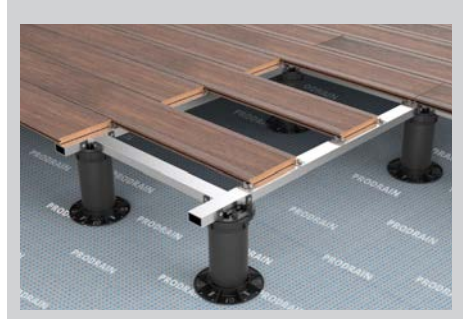

**PATENTED**



PROSUPPORT  
TUBE

PRORAIL RING

PRORAIL

PRODRAIN 10  
(OPTIONAL)

PRORAIL  
SPACER

PRORAIL  
RUBBER



# PROSUPPORT SLIM SYSTEM

**PROSUPPORT SLIM** is a modular system to make outdoor floating floors from 10 to 40 mm height, it is composed of two bases of 10 mm height, levellers of 10 mm thickness and anti-noise and anti-slip disks. Thanks its modularity the system allows to make, from a height of 10 mm, all heights with 2 mm interval using the levellers.



BASE WITH FLAPS  
PSTSB 02 - 2 mm



BASE WITH FLAPS  
PSTSB 04 - 4 mm



LEVELER  
PSTSL 02 - 2 mm



ANTI-NOISE AND ANTI-SLIP DISK  
PSTSG

BASE with flaps 2/4 mm  
polypropylene - Pack 120 Pc.

Article	Thickness (mm)	Pcs/pack		
PSTSB 02	2	120		
PSTSB 04	4	120		

LEVELLER  
Polystyrene - Pack 120 Pc.

Article	Thickness (mm)	Pcs/pack		
PSTSL 02	2	120		

ANTI-NOISE AND ANTI-SLIP DISK  
rubber - pack. 120 pcs

Article	H/Ø mm	Pcs/pack		
PSTSG	H 1,5 - Ø 150	120		

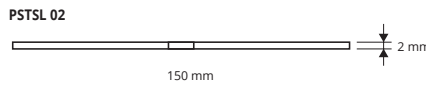
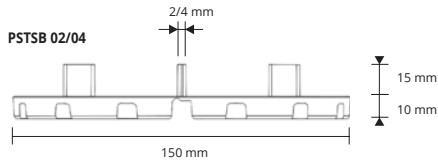

## ACHIEVABLE HEIGHTS WITH PROSUPPORT SLIM SYSTEM

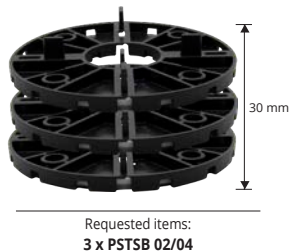
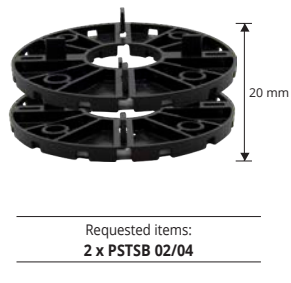
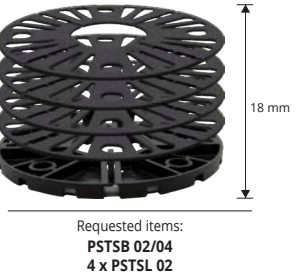
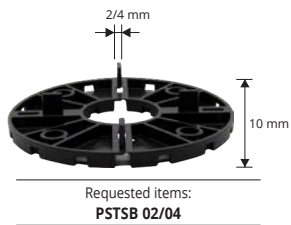

TO OBTAIN MORE THAN 30 mm HEIGHTS USE THE PROSUPPORT TUBE SYSTEM WITH WHICH IT'S POSSIBLE TO OBTAINI HEIGHTS FROM 29 mm UP TO A MAXIMUM OF 1000 mm.



**SUPPORT** and **LEVELLER** are suitable for the realization of outdoor floating floors. The support, in polyethylene, has a height of 15 mm. The rubber leveler, with a thickness of 3 mm, can be applied on the supports up to a maximum of 2. **SUPPORT** and **LEVELLER** are suitable for outdoor areas, terraces, pool edges and pedestrian crossings.

## SUPPORT AND LEVELLER

POLYETHYLENE

### SQUARES SUPPORT

boxes of 350 Pcs

Article	Thick. mm
SQG 15	15

ITEMS NOT FOR SALE INDIVIDUALLY.



SUPPORT

### SQUARES LEVELLER

boxes of 100 Pcs

Article	Thick. mm
LQG 03	3

ITEMS NOT FOR SALE INDIVIDUALLY.



LEVELER



### SQG 15

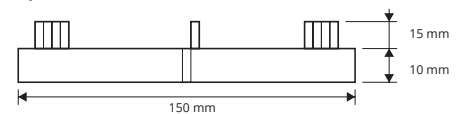

### LQG 03

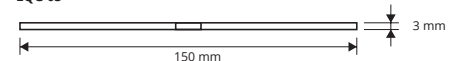

### LAYING INSTRUCTIONS

1. Lay the supports on the waterproofing membrane. 2. To reach the desired height or compensate different heights, if necessary, place 1 or 2 rubber levelers on the support. 3. Lay the floating flooring.



## MAGNET KIT

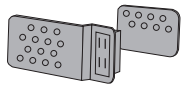

**MAGNET KIT - 4 magnets and 4 plates**  
for ceramic inspection panel - packs of **10 kits**

Article	
KMD	

## SCISSORS FOR PVC PROFILES



**SCISSORS**  
for cutting PVC profiles

Article	
FTPP	

## PROECOFON

EXPANDED POLYETHYLENE CLOSED - CELL

**PROECOFON** is a roll of closed-cell polyethylene used as edging between the wall and screed or where there are expansion joints. It should be used in all floor-laying work to ensure long life of the floor.



### CLOSED-CELL EXPANDED POLYETHYLENE

Article	Thick. x H mm	lm/roll		
PEF 550A	5 X 50	25		
PEFPU 510A	5 X 10	2,7		
PEF 5100A	5 X 100	100		

For perimeter areas and joints.  
PEFPU 510A for Prot Terrace Drain Drip

### EXAMPLE OF LAYING

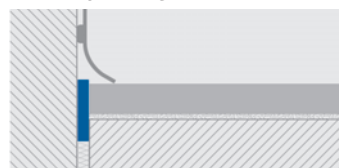

## PROBAND FIX

MONOCOMPONENT WATERPROOF SEALANT



### SEALANT MONOCOMPONENT WATERPROOF

Pack of **12** cartridges

Article	Cartridge lm		
PRBFXB	290		
PRBFXG	290		

### DISPENSING GUN FOR SEALANT CARTRIDGES

Article	Pc/Pack		
PRBFXGUN	1		

### SEALANT MONOCOMPONENT WATERPROOF CARTRIDGE

Pack of **12** cartridges

Article	Cartridge lm		
PRBFXUB	600		
PRBFXUG	600		

### COLOURS

B - White	G - Grey

### Technical data:

Appearance:	white or gray thixotropic paste
Temperature range for application:	+ 5 °C / + 40 °C
Temperature range:	- 40 °C / + 90 °C
Curing:	≈ 2 mm / 24 h
Commissioning:	≈ 7 days

### Suggestions for the installation:

In general cementitious support must be free from dust, oil and grease, dry and free from any visible moisture, free of loose or imperfectly anchored parts such as residual traces of cement, lime and paint, which must be totally removed. In case of contact with eyes, rinse immediately with water and seek medical advice. Avoid contact with skin and keep out of reach of children.

- **Use**  
Balconies, terraces, bathrooms, kitchens, saunas, swimming pools and exterior surfaces of any size.
- **Don't use**  
On bitumen membranes.  
To seal proband with PRODES0®.

## PROPOLISH

WHITE CREAM - BASED SURFACTANTS  
SUITABLE FOR CLEANING

White cream - based surfactants, amines and inert powder, suitable for cleaning, degreasing and polishing of stainless steel surfaces and opaque/matt brass. The product, ready to use, does not contain acids and alkalis and do not leave marks after use. It does not emit harmful substances



Article	Pack. g.	Pcs/Pack		
PRLISH	250	6		

## PROCARE CLEAN

CLEANING SPRAY

Cleaning spray ready to use suitable for cleaning of stainless steel, brass and aluminum profiles, from residual surface oxide and limestone. The product deposit a protective film that prevents the deposit of limestone and soap residues. Its periodic use allows to obtain bright and cleaner surfaces for long period. Suitable also for glasses, mirrors and bathroom fittings.



Article	Pack. lm	Pcs/Pack.		
PRCLEAN	750	6		





**TROWEL** in steel foil 3x3, support in polished aluminium with electro welded fixing. Rubber grip fixed with an anti-rotation system. Particularly suitable for the laying of the waterproofing system PROFOL.

## TROWEL

STEEL

### TROWEL STEINLESS STEEL

Box 6 Pcs

Article	Tooth	Dimensions mm	Pcs/Box
PFTT33	3X3	280X120	6

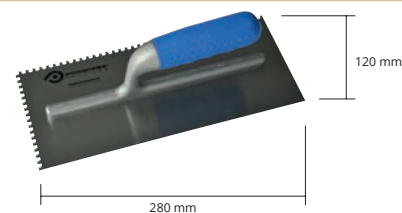

**TROWEL** in steel foil 5x7, support in polished aluminium with electro welded fixing. Rubber grip fixed with an anti-rotation system. Particularly suitable for the laying of the waterproofing and uncoupling systems PRODESO® and PRODESO® HEAT & PRODESO® HEAT GRIP.

## TROWEL

STEEL

### TROWEL STEINLESS STEEL

Box 6 Pcs

Article	Tooth	Dimensions mm	Pcs/Box
PFTT57	5X7	280X121	6



**TROWEL** in steel foil 10x10, support in polished aluminium with electro welded fixing. Rubber grip fixed with an anti-rotation system. Particularly suitable for the laying of tiles above the waterproofing and uncoupling systems PRODESO® and PRODESO® HEAT & PRODESO® HEAT GRIP.

## TROWEL

STEEL

### TROWEL STEINLESS STEEL

Box 6 Pcs

Article	Tooth	Dimensions mm	Pcs/Box
PFTT1010	10X10	280X122	6

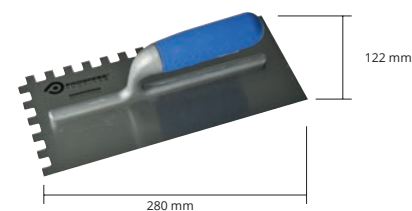

**TROWEL in PVC** size 10x10 cm, resistant to solvents, with a triangular teeth of interaxle spacing of 5 mm, 4 mm and 3 mm. To be used for the application of adhesives PROBAND FIX.

## TROWEL

PVC

### TROWEL

Article	Dimensions mm
PRSPD 10	100x100

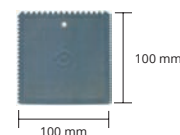

**ROLLER** in nylon, 40 cm long, fixed to a varnished metal or stainless steel 304 frame, suitable for pressing the PRODESO®, PRODESO® HEAT & PRODESO® HEAT GRIP and PROFOL. The roller is equipped with an extendable grip, length-adjustable and with an L base that allows to load 1 bag of adhesive to obtain the correct and homogenous pressing of the membranes. A tripod allows to keep the roll in the right position while loading the bag.

## ROLLER

VARNISHED STEEL OR STAINLESS STEEL

### ROLLER IN STAINLESS STEEL

L 40 cm

Article	L mm	Finish
PSM	400	varnished
PSMAC	400	steel



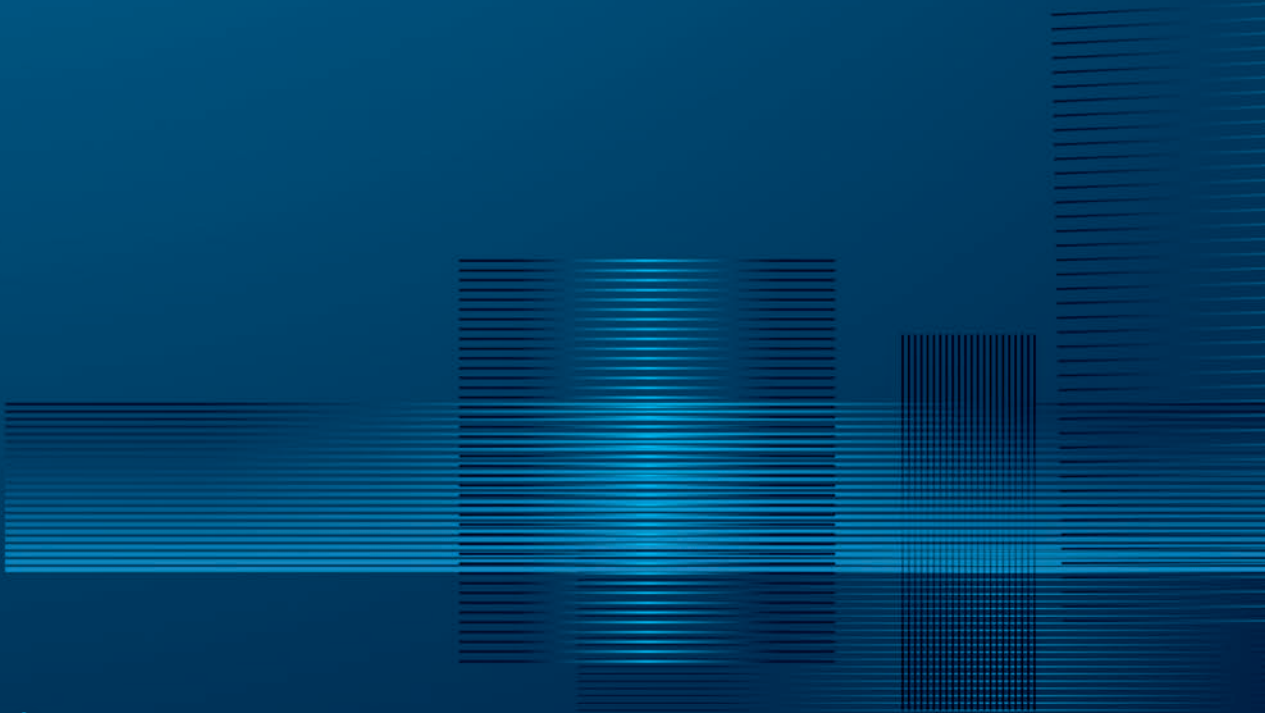

An interpretation of:  
**Premier Tower, Elenberg Fraser, MELBOURNE (Australia)**

BUILDING SYSTEMS



# SNAP-ON STRAND SHEATH

GREY RIGID PVC

The **SNAP-ON PVC STRAND SHEATH** serves to cover/neutralise the reinforcement strands inside the prestressed beams; the sheath cancels out the stress that the strands transmit to the beam, thereby permitting the positive to be changed to left-handed moments. Available in various diameters and lengths.

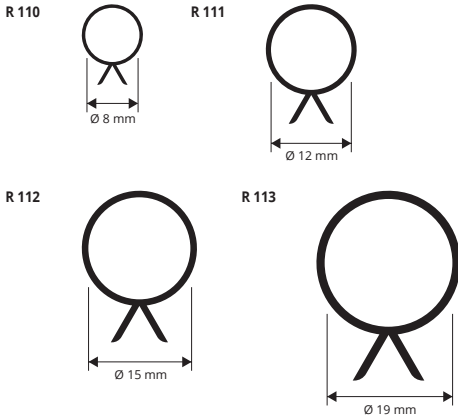

## GREY RIGID PVC

bar length 3 lm - pack, 50 Pcs - 150 lm

Article	Ø inches	Ø mm
R 110	3 x 3"	8
R 111	3 / 8"	12
R 112	1 / 2"	15
R 113	0' 6"	19

R 110/ 111: 15.000 lm / pallets  
R 112/113: 10.800 lm / pallets

### EXAMPLES AND INSTRUCTIONS FOR LAYING METHODS

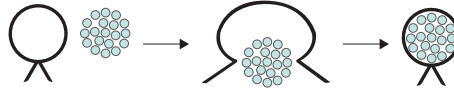

Laying is extremely simple by just positioning the sheath so that the "V" shaped flanges are facing the prestressed reinforcement strands that are already in situ and gently pressing until the sheath snaps on.

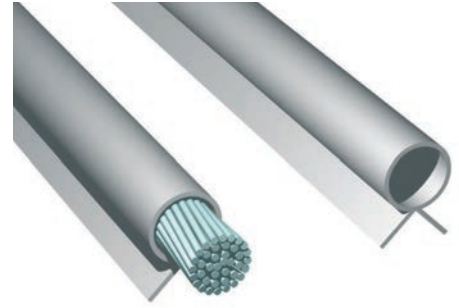

# SNAP-ON STRAND TUBE

GREY RIGID PVC

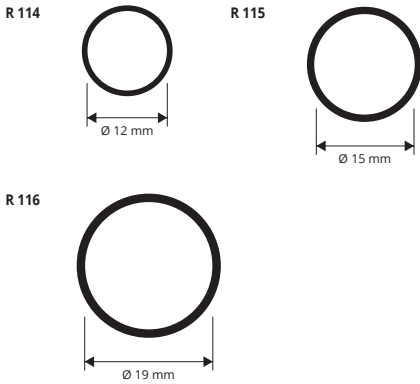

## GREY RIGID PVC

bar length 3 lm - pack, 50 Pcs - 150 lm

Article	Ø inches	Ø mm
R 114	3/8"	12
R 115	1/2"	15
R 116	0/6"	19

R 114/ 115: 15.000 lm / pallets  
R 116: 12.000 lm / pallets

### COLOURS



G - Grey

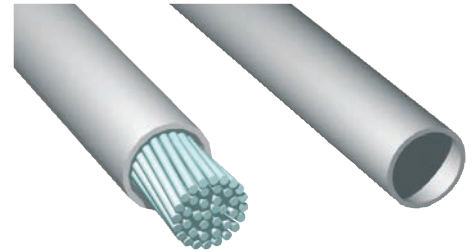

### LAYING INSTRUCTIONS

Laying is very simple; just insert the casing over the strands before they are tensioned.

# FINNED DISTANCE TUBE

GREY RIGID PVC

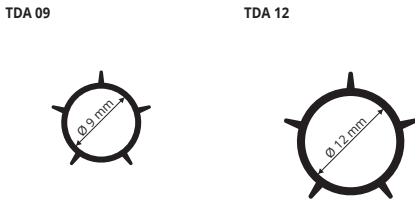

## GREY RIGID PVC

bar length 2 lm - pack, 50 Pcs - 100 lm

Article	Ø mm
TDA 09	9
TDA 12	12

TDA 09: 15.000 lm / pallets  
TDA 12: 10.000 lm / pallets

### COLOURS



G - Grey



### LAYING INSTRUCTIONS

Laying is very simple:  
1. Just insert the iron rod into the finned tube before closing the reinforcement panel.  
2. Upon removing the reinforcement panels, if necessary insert the end plugs.

# END CAPS FOR DISTANCE TUBE

GREY HD POLYPROPYLENE

PPT 09 / 12



## SMOOTH END CAPS - GREY HD POLYPROPYLENE

pack, 1000 Pcs

Article	Ø mm
PPT 09	9
PPT 12	12

# RIBBED DISTANCE TUBE

GREY RIGID PVC

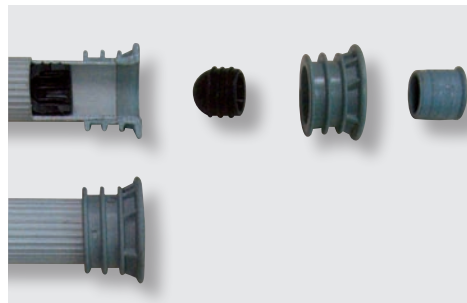
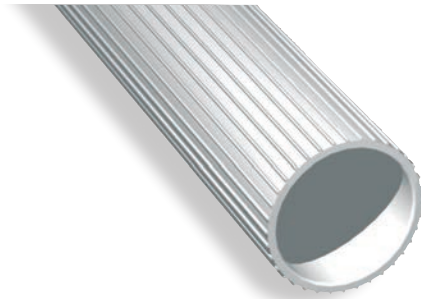

PPD 20

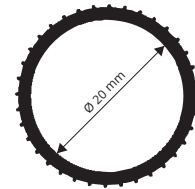

PPD 22

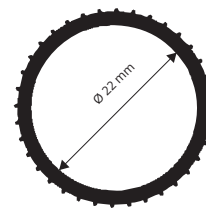

PPD 26

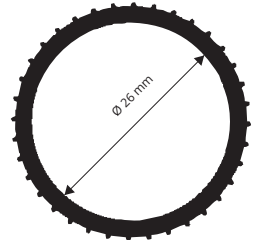

## GREY RIGID PVC

bar length 2 lm - pack. 25 Pcs - 50 lm

Article	Ø mm inside		
PPD 20	20		
PPD 22	22		
PPD 26	26		

PPD 20/ PPD 22: 5.000 lm / pallets  
PPD 26: 3.000 lm / pallets

## COLOURS



# WASHERS AND END CAPS FOR DISTANCE TUBE

GREY HD POLYPROPYLENE - PVC / RUBBER

## WASHERS - GREY HD POLYPROPYLENE

pack. 1000 Pcs

Article	Ø mm outside		
PPR 20	20		
PPR 22	22		
PPR 26	26		

## OUTSIDE WASHERS - GREY HD POLYPROPYLENE

pack. 1000 Pcs

Article	Ø mm		
RETDB 22	26		

## INSIDE END CAPS - PVC / RUBBER

pack. 2000 PCS divided into two 1000 Pcs bags

Article	Ø mm		
TIGPC 22	22		

## SMOOTH PLUGS - GREY HD POLYPROPYLENE

(PPT 20/ 22/ 26 pack. 2000 Pcs divided into two 1000 Pcs bags)

Article	Ø mm	Pcs/Pack.		
PPT 09	9	1000		
PPT 12	12	1000		
PPT 16	16	1000		
PPT 20	20	2000		
PPT 22	22	2000		
PPT 26	26	2000		

## HOLLOW PLUGS - GREY HD POLYPROPYLENE

pack. 2000 Pcs divided into two 1000 Pcs bags

Article	Ø mm	Pcs/Pack.		
PPTC 22	22	2000		

SMOOTH PLUG  
for walls without plaster

HOLLOW PLUG  
for plaster



PPR 20 / 22 / 26

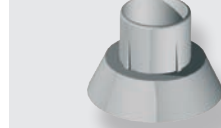

PPT 09 / 12 / 16 / 20 / 22 / 26



RETDB 22



TIGPC 22

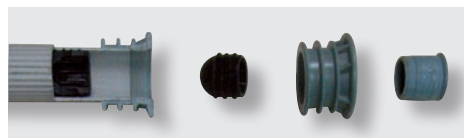

# DRIP

GREY RIGID PVC

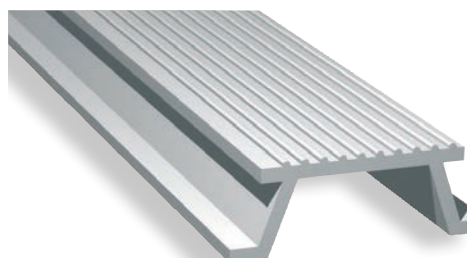
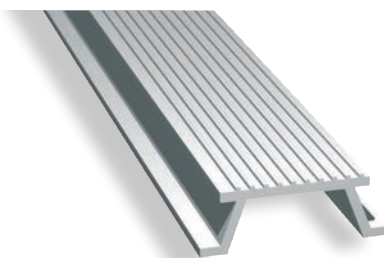

## GREY RIGID PVC

bar length 2 lm - pack. 50 Pcs - 100 lm

Article	L x H mm		
GCT 20	20 x 12		
GCT 30	30 x 15		

GCT 20: 15.000 lm / pallets  
GCT 30: 10.000 lm / pallets

## COLOURS



GCT 20

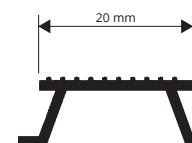

GCT 30

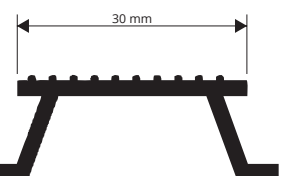

## LAYING INSTRUCTIONS

Must be fixed below the sheathing/armature to create the drip course.

\* = Production on demand with minimum quantity of 10000 pcs. Production delay 4/5 weeks. Price to be agreed.



# PROFILE WITH TRIANGULAR CHAMFER

GREY RIGID PVC

The **TRIANGULAR CHAMFER** is made in grey rigid PVC in various widths 10-15-20-30 mm and standard length of 2 lm. It is mainly used to chamfer the corners of the concrete pours when making, for example, walls-columns etc. It is strong and easy to lay.

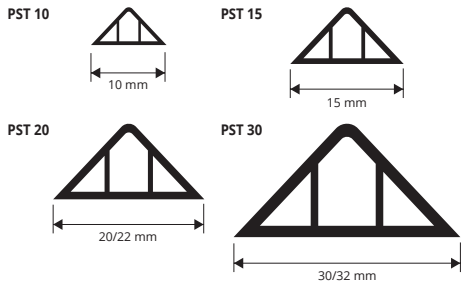

**LAYING INSTRUCTIONS**  
Put the nails into the central part along the profile before pouring the concrete.

**GREY RIGID PVC**  
bar length **2 lm** - pack, **50 Pcs** - 100 lm

Article	Width mm		
PST 10	10		
PST 15	15		

20.000 lm pallets

**GREY RIGID PVC**  
bar length **2 lm** - pack, **50 Pcs** - 100 lm

Article	Width mm		
PST 20	20/22		
PST 30	30/32		

PST 20: 15.000 lm / pallets  
PST 30: 10.000 lm / pallets

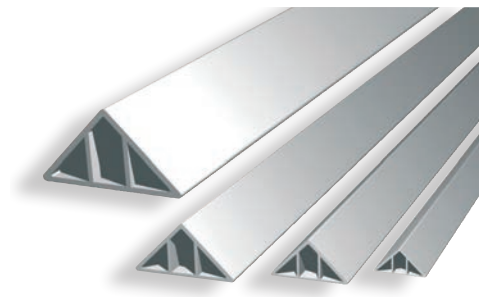

# ROUNDED TRIANGULAR CHAMFER FILLET

GREY RIGID PVC

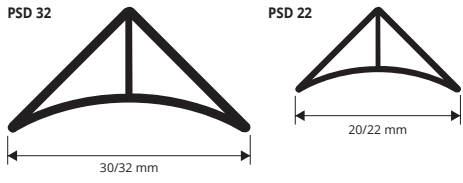

**LAYING INSTRUCTIONS**  
Put the nails into the central part along the profile before pouring the concrete.

**GREY RIGID PVC**  
bar length **2 lm** - pack, **50 Pcs** - 100 lm

Article	L mm		
PSD 22	20/22		
PSD 32	30/32		

PST 22: 15.000 lm / pallets  
PST 32: 10.000 lm / pallets

**COLOURS**

	G - Grey
--	----------

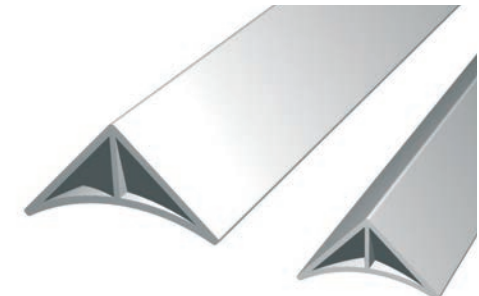

# FISHBONE RIBBED JOINT

GREY RIGID PVC

**COLOURS**

	G - Grey
--	----------

**GREY RIGID PVC**  
bar length **2 lm** - pack, **50 Pcs** - 100 lm

Article	H x L mm		
GRP 25	25 X 5		
GRP 45	45 X 5		

GRP 25: 10.000 lm / pallets  
GRP 45: 5.000 lm / pallets

**LAYING INSTRUCTIONS**  
Laying is very simple: just insert the ribbed joint into the gap deliberately left in the concrete or the screed.

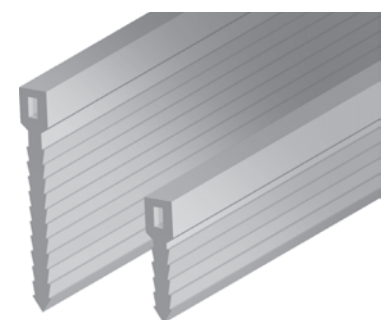

# PROFILE WITH DOUBLE CHAMFER - FOR BALCONIES

GREY RIGID PVC

**COLOURS**

	G - Grey
--	----------

**GREY RIGID PVC**  
on demand bar length

Article	H mm		
R 117	80		*

**PROFILE SPECIFICATIONS:**

- Chamfer angle 45°
- Chamfer length 20 mm
- Bar length on demand
- Weight x metre ≈ 2,3 Kg

**LAYING INSTRUCTIONS**  
Laying is very simple: just fix it with nails or clamps in the relative formwork prior to pouring the concrete.

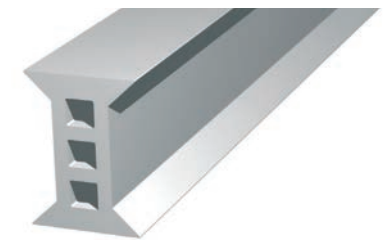

\* = Production on demand with minimum quantity of 100 pcs. Production delay 4/5 weeks. Price to be agreed.



The **WATERSTOPS** profiles are made in high-quality polyvinyl chloride (plasticized PVC) and have excellent physical-mechanical properties, strength, flexibility, resistance to ageing and fluid-tightness even under pressure. The "Flat Waterstop" model art. WP is used for adjacent pours of concrete, while the "Waterstop with Bulb" model art. WB is used in concrete casting but as an expansion joint, thanks to the central bulb. They find many applications: floors, underground rooms, trench ducts/ underground passages, face walls, cisterns, silos, swimming pools, tanks, canals, dams, aqueducts, etc. The quality of the materials allows the waterstops to be used on concrete structures exposed to temperatures between  $-30^{\circ}\text{C}$  and  $+70^{\circ}\text{C}$ , also ensuring good resistance to chemicals in alkaline environments, to brackish waters and to acid solutions.

# WATERSTOP

PLASTICIZED PVC BLUE

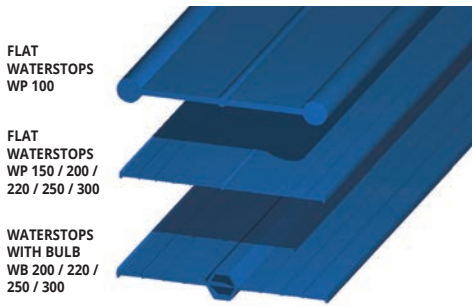

**FLAT WATERSTOPS - PLASTICIZED PVC BLUE**  
pack. rolls 25 lm (WP 150 - pack. rolls 50 lm)

Article	L mm
WP 100	100
WP 150 (50 ml)	150
WP 200	200
WP 220	220
WP 250	250
WP 300	300

ANCHORING CLIPS for WATERSTOPS on demand.



**WATERSTOPS WITH BULB - PLASTICIZED PVC BLUE**  
pack. rolls 25 lm

Article	L mm
WB 200	200
WB 220	220
WB 250	250
WB 300	300

ANCHORING CLIPS for WATERSTOPS on demand.

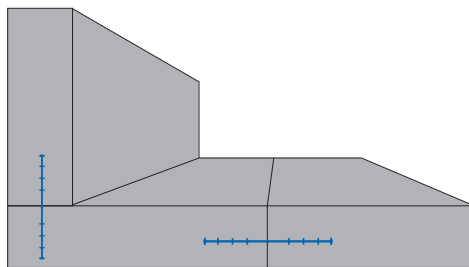

### SEALING OF WATERSTOPS

The Waterstops may be welded together to obtain a single piece of the required length. The two parts must be properly cleaned for perfect fluid-tightness of the joints. The waterstops are usually field welded using a normal hot-air heater on the ends of the sections. The bond is accomplished by melting the material and pressing one end over the other.

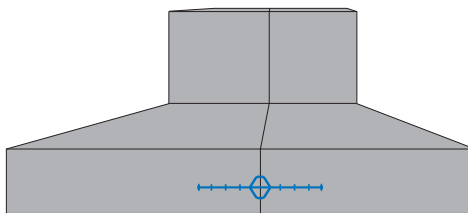

### COLOURS

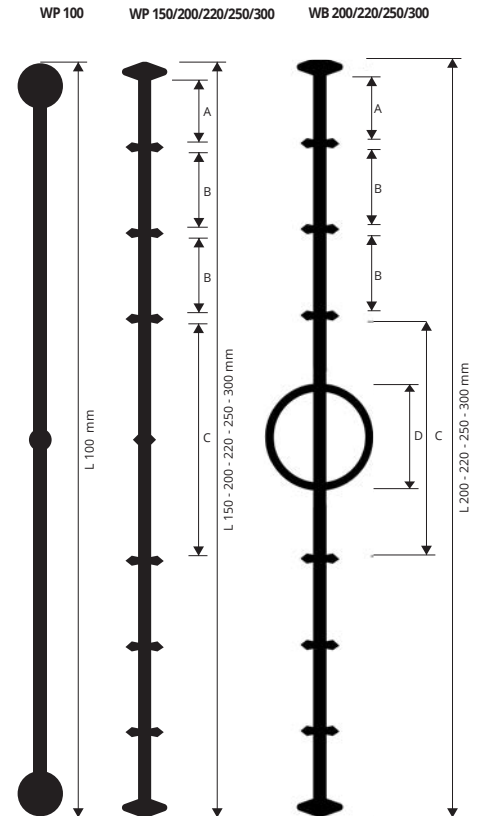

profiles for adjacent pours of concrete

### SIZE

ART.	A	B	C	D
WP 100	40 mm			
WP 150	13,3 mm	15,5 mm	45,5 mm	
WP 200	22 mm	22 mm	50 mm	
WP 220	23 mm	25 mm	50 mm	
WP 250	19 mm	21 mm	71,5 mm	
WP 300	20,5 mm	22,5 mm	78 mm	
WB 200	16 mm	18 mm	85 mm	32 mm
WB 220	16 mm	18,5 mm	86 mm	33 mm
WB 250	26 mm	20 mm	84 mm	30 mm
WB 300	26 mm	22 mm	88 mm	34 mm

## ANCHORING CLIPS FOR WATERSTOPS

GREY UH POLYPROPYLENE

**GREY HD POLYPROPYLENE**  
pack. 1000 Pcs

Article
CLPS

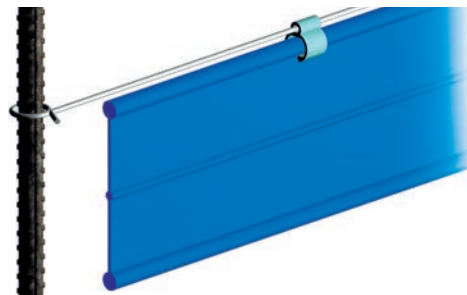

\* = Production on demand with minimum quantity of 10 rolls. Production delay 4/5 weeks. Price to be agreed.



# PRODISTANZ

GREY HD PLYPROPYLENE

**PRODISTANZ** is a patented new product that simplifies, improves and speeds up the work of securing and preparing shuttering panels used in the casting of concrete; it avoids the cutting and assembling in situ of the tubular water-washer (traditional system). **PRODISTANZ** is recommended for its special, very strong structure, which is resistant to compressive stress and prevents water infiltration thanks to the lateral ribs along the cylindrical part and the horizontal supports and circles. It consists of a single plastic element and is available in a wide range of lengths 15-20-25-30-35-40 cm (in packs of 100 Pcs.). They come with watertight plugs in a choice of two types. Watertight caps at 18 Atm. / Bar.

spacers

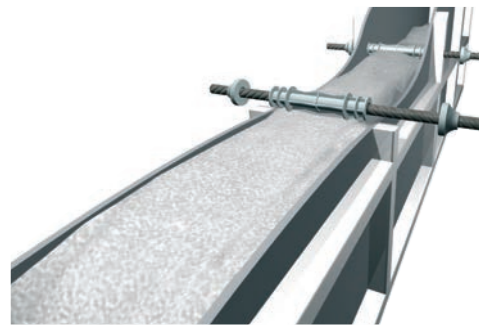
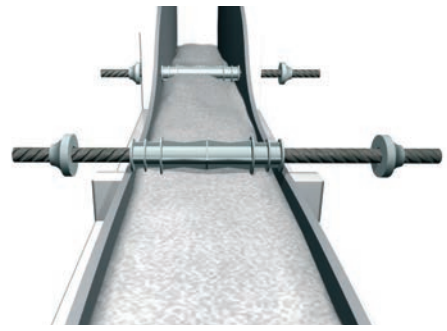
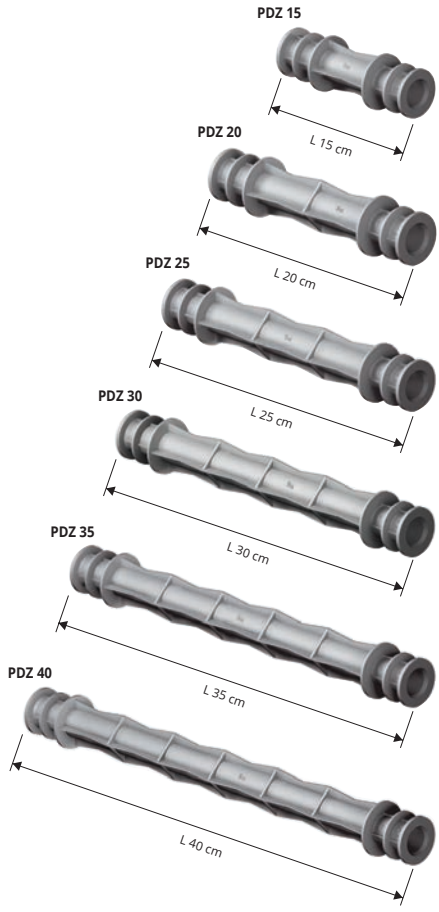

**GREY HD POLYPROPYLENE**  
pack. 100 Pcs + 200 end caps

Article	L cm		
PDZ 15	15		
PDZ 20	20		
PDZ 25	25		
PDZ 30	30		
PDZ 35	35		
PDZ 40	40		

**SIMPLE FAST ECONOMIC**

- Exclusive patented product
- High resistance to compressive stress and to water infiltration
- Fast, assured work, without waste, cutting costs or pipe scraps
- Extremely easy to use
- Vast range available: 15-20-25-30-35-40 cm
- Innovative design - guaranteed
- Quality - Constant colour and quality



## END CAPS AND JOINTS FOR PRODISTANZ

GREY HD POLYPROPYLENE - PVC/RUBBER



Hollow plug: for better anchorage of the plaster. (new) standard.

**HOLLOW END CAPS - GREY HD POLYPROPYLENE**  
pack. 2000 Pcs divided into two 1000 Pcs bags

Article	Ø mm	Pcs/Pack.		
PPTC 22	22	2000		

**SMOOTH PLUGS - GREY HD POLYPROPYLENE**  
pack. 2000 Pcs divided into two 1000 Pcs bags

Article	Ø mm	Pcs/Pack.		
PPT 22	22	2000		

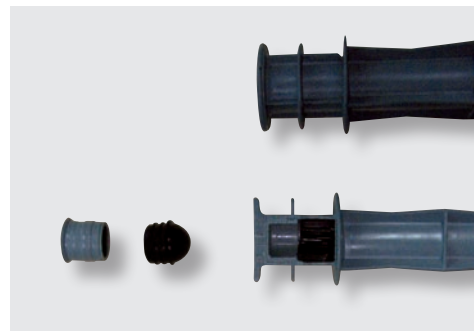

**INSIDE END CAPS - PVC/RUBBER**

pack. 2000 Pcs divided into two 1000 Pcs bags

Article	Ø mm		
TIGPC 22	22		

**JOINT - GREY HD POLYPROPYLENE**

pack. 1000 Pcs divided into two 500 Pcs bags

Article	Ø mm		
GPDZ 22	22		

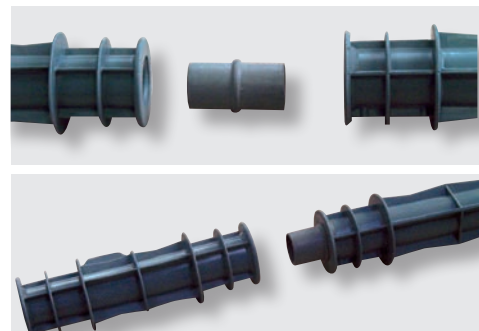

\* = Production on demand with minimum quantity of 10000 pcs. Production delay 4/5 weeks. Price to be agreed.



The linear spacer **RAPY 100** is strong and resistant, capable of bearing heavy loads thanks to its shape and size. The lateral and horizontal holes allow perfect penetration of the concrete. Upside down it can be used on insulating panels for floors. Spacers may be joined together longitudinally with a simple slot-in system. Ideal for precasting and civil industry, it ensures stability and invisible finish. On demand available in 50 cm cut.

## RAPY 100 FOR HEAVY MESH

GREY HD POLYPROPYLENE

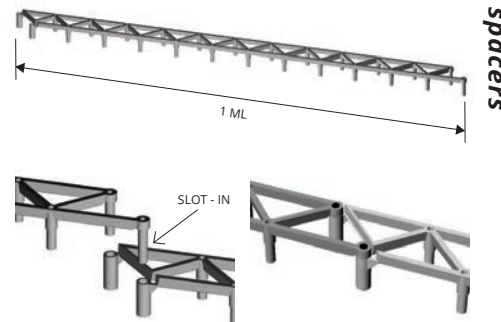
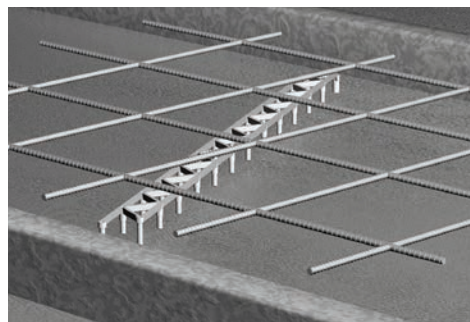
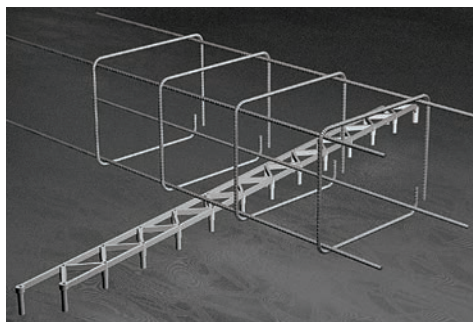

GREY HD POLYPROPYLENE  
length 1 lm - pack. 80 lm

Article	H mm		
PLF 20	20		
PLF 25	25		
PLF 30	30		

Maximum weight:  
3000 kg a piece (bar length: 1lm) equally distributed.

GREY HD POLYPROPYLENE  
length 1 lm - pack. 60 lm

Article	H mm		
PLF 35	35		
PLF 40	40		
PLF 45	45		
PLF 50	50		
PLF 55	55		
PLF 60	60		



Strong and very resistant linear spacer, to be joined lengthwise and have several lengths. The new shape allows to combine high technical performances to a costs optimization.

## RAPY 100 ECO

GREY HD POLYPROPYLENE

RAPY 100 ECO  
length 1 lm - pack. 64 lm

Article	H mm		
PLFE 20	20		
PLFE 25	25		
PLFE 30	30		
PLFE 35	35		
PLFE 40	40		

ARTICLES NOT FOR SALE SINGLY

RAPY 100 ECO  
length 1 lm - pack. 64 lm

Article	H mm		
PLFE 45	45		
PLFE 50	50		
PLFE 55	55		
PLFE 60	60		

ARTICLES NOT FOR SALE SINGLY



The **RAPY 200** spacer is sturdy, resistant and easy to place. Ideal for reinforced horizontal, vertical and sloped structures. The side and horizontal holes allow it to perfectly penetrate into the concrete. When flipped over, it can be used for insulation panels, floors and precast structures. On demand available at 1 metre.

## RAPY 200

GREY HD POLYPROPYLENE

GREY HD POLYPROPYLENE  
length 2 lm - pack. 96 lm

Article	H mm		
PLF 20R	20		
PLF 25R	25		
PLF 30R	30		
PLF 40R	40		

Maximum weight: 3000 kg a piece (bar length: 2 lm) equally distributed.  
The spacer is made up of two 1 lm pieces joined together.

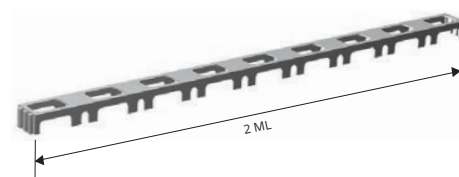

Spacer for horizontal use for heavy reinforcement and meshes; it withstands heavy incidental weights and loads with great stability.

## MULTIPIEDE

GREY HD POLYETHYLENE

GREY HD POLYPROPYLENE  
bar length 50 cm - Pack. 100 Pcs (DMP 30 - Pack 75 Pcs)

Article	H mm		
DMP 20	20		
DMP 25	25		
DMP 30	30		*

Maximum weight:  
2.500 kg a piece (bar length: 50 cm) equally distributed.

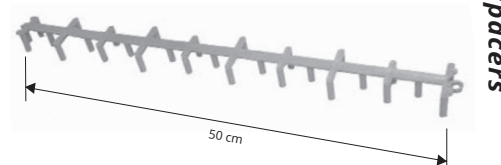

\* = Production on demand with minimum quantity of 10000 pcs. Production delay 4/5 weeks. Price to be agreed.



## TYPE "PAV" WHEEL

GREY HD POLYPROPYLENE

The circular spacer **PAV** is a patented and innovative product to resolve problems with the laying of spacers for electrically welded mesh, using rods of different diameter  $\varnothing$  4-6-8-10-12 mm and thereby avoiding the purchase of other types of spacers for iron with larger diameter.

spacers for electrically welded mesh

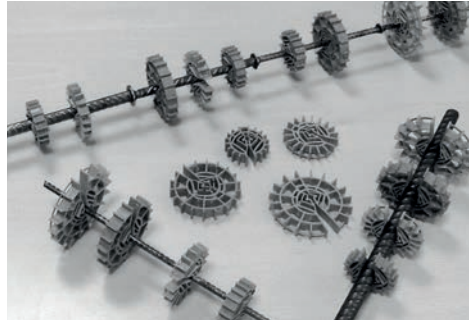
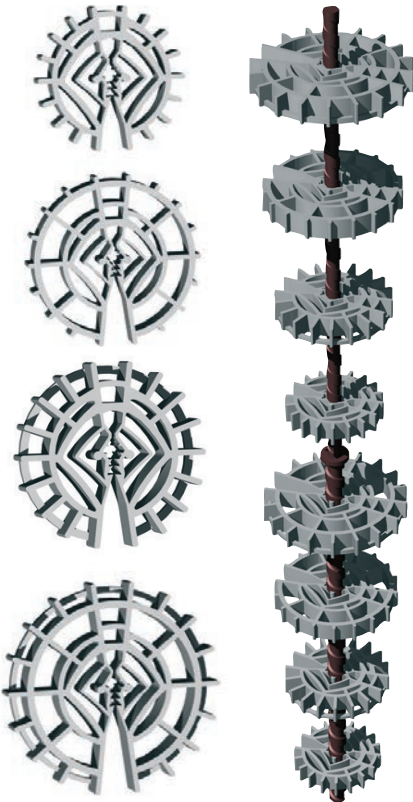

GREY HD POLYPROPYLENE  
pack. 2000 Pcs

Article	Formwork spacer mm	$\varnothing$ rod mm		
PPV 10	10	4/8		
PPV 15	15	4/8		

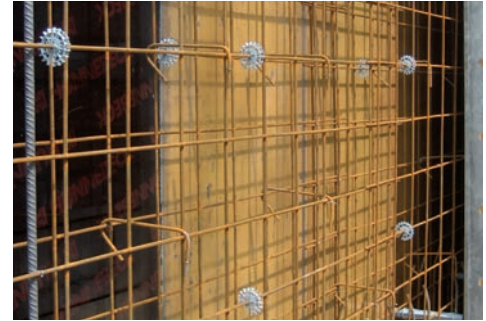
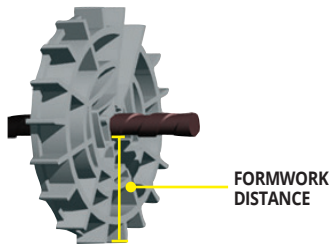

GREY HD POLYPROPYLENE  
pack. 1000 Pcs

Article	Formwork spacer mm	$\varnothing$ rod mm		
PPV 20	20	4/8		
PPV 25	25	4/12		
PPV 30	30	4/12		

GREY HD POLYPROPYLENE  
pack. 500 Pcs

Article	Formwork spacer mm	$\varnothing$ rod mm		
PPV 40	40	8/16		
PPV 50	50	8/16		

**NEW PATENTED UNIVERSAL MODEL FOR RODS  $\varnothing$  4/12 MM.**  
**THE ADVANTAGES OF THE NEW PAV RANGE ARE AS FOLLOWS:**  
**1st** The only universal spacer for 4 to 12 mm rods.  
**2nd** Easy to insert.  
**3rd** Innovative and technical design.

## TYPE "PAU" TOWER

GREY HD POLYPROPYLENE

The universal spacer **PAU** can be used either horizontally or vertically. Strong and resistant, it can bear heavy loads and is easy to fit. Recommended for cross application of wires in electro-welded or welded meshes.

spacers for electrically welded mesh

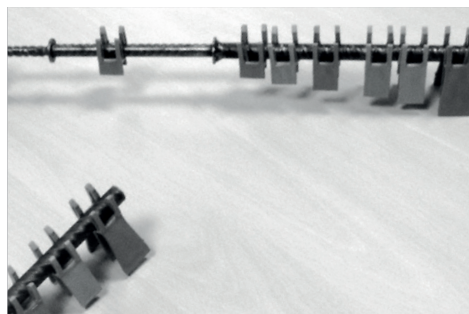
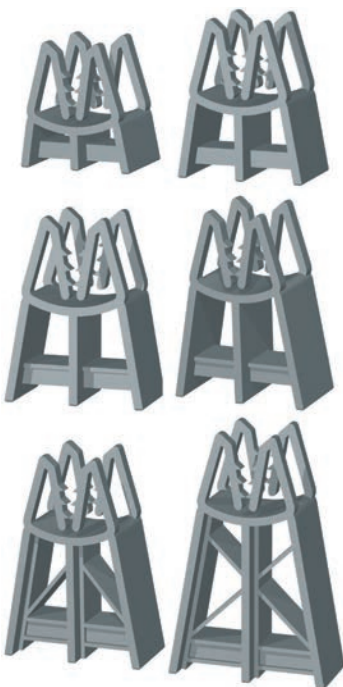

GREY HD POLYPROPYLENE  
pack. 4000 Pcs (PPU 10) - pack. 3000 Pcs (PPU 15)

Article	Formwork spacer mm	$\varnothing$ rod mm		
PPU 10	10	4/12		
PPU 15	15	4/12		

GREY HD POLYPROPYLENE  
pack. 1000 Pcs

Article	Formwork spacer mm	$\varnothing$ rod mm		
PPU 30	30	4/12		
PPU 40	40	4/12		

**NEW PATENTED UNIVERSAL MODEL FOR RODS  $\varnothing$  4/12 MM.**  
**THE ADVANTAGES OF THE NEW PAV RANGE ARE AS FOLLOWS:**  
**1st** The only universal spacer for 4 to 12 mm rods.  
**2nd** Easy to insert.  
**3rd** innovative and technical design.

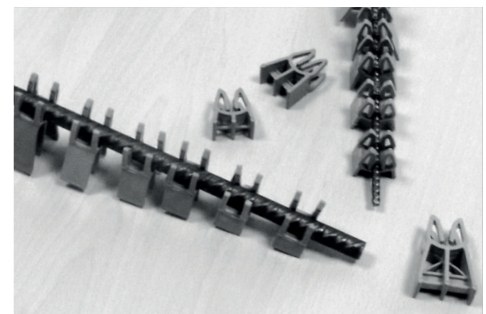

GREY HD POLYPROPYLENE  
pack. 2000 Pcs

Article	Formwork spacer mm	$\varnothing$ rod mm		
PPU 20	20	4/12		
PPU 25	25	4/12		

**SPACER** for vertical and horizontal meshes. complete with hooks fixing to mesh. dimensions 192 x 90 mm.

## SPACER FOR VERTICAL/HORIZONTAL MESH

GREY HD POLYETHYLENE

GREY HD POLYETHYLENE  
length 192 mm - width 90 mm

Article		H mm		
DVO 10	400	10		
DVO 15	400	15		
DVO 20	300	20		
DVO 25	120	25		
DVO 30	250	30		
DVO 35	200	35		

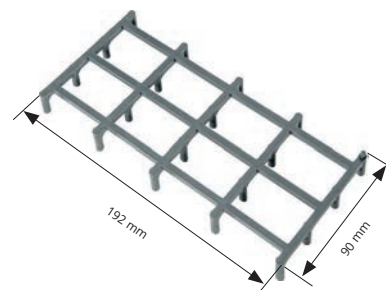

spacers

## SPACER FOR GLASS BRICK

HD STYROFOAM

WHITE HD STYROFOAM  
pack. 600 Pcs

Article	Thick mm		
DSVT	10		*

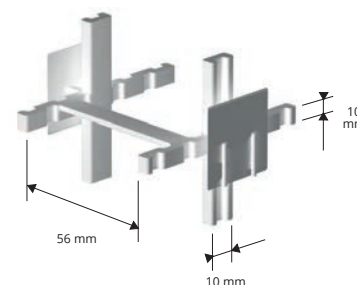

spacers

With the **DOPPY** type spacer with double slot, two  $\varnothing$  4 to 8 mm mesh reinforcements may be kept simultaneously at the same distance from the formwork.

## TYPE "DOPPY" WITH DOUBLE SLOT

GREY HD POLYPROPYLENE

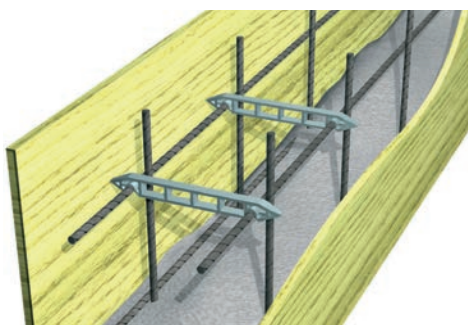

GREY HD POLYPROPYLENE - for mesh up to  $\varnothing$  8 mm  
pack. 500 Pcs

Article	mesh dist. L mm		
PPY 15	100		*

GREY HD POLYPROPYLENE - for mesh up to  $\varnothing$  8 mm  
pack. 250 Pcs

Article	mesh dist. L mm		
PPY 20	150		*
PPY 25	200		*
PPY 30	250		*

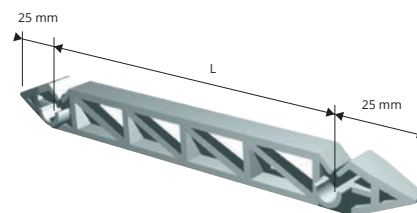

spacers

\* = Production on demand with minimum quantity of 10000 pcs. Production delay 4/5 weeks. Price to be agreed.



# PROTECTIVE CAPS FOR RODS FOR ADJACENT POURS

The **PROTECTIVE CAPS** have been created to comply with the safety regulations as per Italian law 81/2008. They protect the end of the protruding rods, thereby preventing injury to operators. Two types for different diameters are available.

HD POLYPROPYLENE

laying products

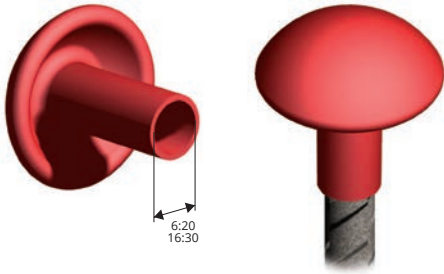

HD POLYPROPYLENE - colour red  
pack. 200 Pcs (divided into two 100 Pcs bags)

Article	Ø mm		
PCPF 620	6/20		
PCPF 1630	16/30		

# FLAT SPACER FOR MOUNTING PREFABRICATED PANELS

HD POLYPROPYLENE

laying products

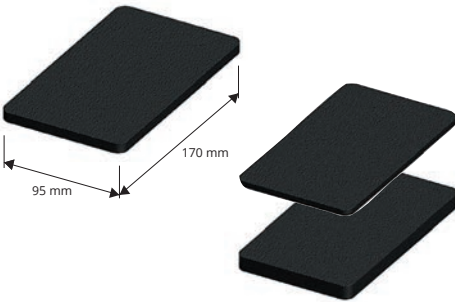

HD POLYPROPYLENE  
size 170 X 95 mm - pack. 400 Pcs

Article	Thick mm.		
PPN 02	2		

HD POLYPROPYLENE  
size 170 X 95 mm - pack. 200 Pcs

Article	Thick mm.		
PPN 05	5		

HD POLYPROPYLENE  
size 170 X 95 mm - pack. 100 Pcs

Article	Thick mm.		
PPN 10	10		

# WEDGE SHIMS

HIGH STRENGTH PLASTIC

laying products

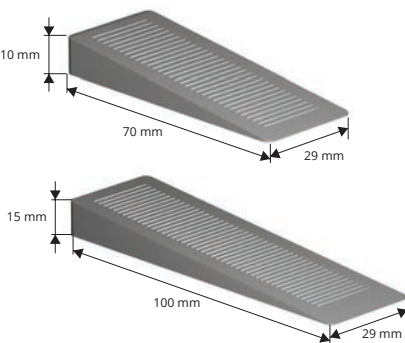

HIGH STRENGTH PLASTIC - standard colour grey  
pack. 100 Pcs

Article	H mm		
SAC 10	10		
SAC 15	15		

The **PAX** spacer is a sturdy spacer used for horizontal mesh; its shape allows the use of  $\varnothing$  10 / 16 mm mesh.

## TYPE "PAX" STURDY

GREY HD POLYETHYLENE

GREY HD POLYETHYLENE -  $\varnothing$  rod 10/16 mm

pack. 2000 Pcs

Article	Formwork spacer mm		
PPX 15	15		

\*\*

GREY HD POLYETHYLENE -  $\varnothing$  rod 10/16 mm

pack. 1000 Pcs

Article	Formwork spacer mm		
PPX 20	20		
PPX 25	25		
PPX 30	30		
PPX 40	40		



spacers for

The **PAL** spacer is a lightweight spacer used to join the iron mesh framework of floor slabs, maintaining the distance from the formwork.

## TYPE "PAL" FOR FLOOR SLABS

GREY HD POLYPROPYLENE

GREY HD POLYPROPYLENE -  $\varnothing$  rod 6+5 mm

pack. 2000 Pcs

Article	Formwork spacer mm		
PPO 15	15		
PPO 20	20		

GREY HD POLYPROPYLENE -  $\varnothing$  rod 6+5 mm

pack. 1000 Pcs

Article	Formwork spacer mm		
PPO 25	25		

\*



welded mesh

The **PAS** spacer is a sturdy spacer used for heavy reinforcement and large diameter rods.

## TYPE "PAS" CHAIR

GREY HD POLYETHYLENE

GREY HD POLYETHYLENE -  $\varnothing$  rod 0/28 mm

pack. 2000 Pcs - divided into two 1000 Pcs bags

Article	Formwork spacer mm		
PPS 15	15		
PPS 20	20		
PPS 25	25		

\*\*

GREY HD POLYETHYLENE -  $\varnothing$  rod 0/28 mm

pack. 1000 Pcs - divided into two 500 Pcs bags

Article	Formwork spacer mm		
PPS 30	30		
PPS 40	40		
PPS 50	50		

\*\*



\* = Production on demand with minimum quantity of 10000 pcs. Production delay 4/5 weeks. Price to be agreed.

\*\* = Production on demand with minimum quantity of 50000 pcs. Production delay 4/5 weeks. Price to be agreed.

# GASKETS FOR PRECAST FORMS

PVC / RUBBER

gaskets for industrial precast forms

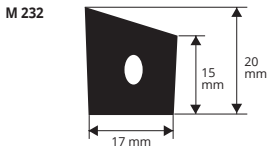

PVC / RUBBER  
length rolls 50 lm

Article	
M 232	*

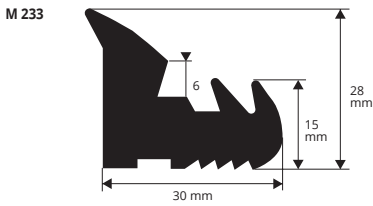
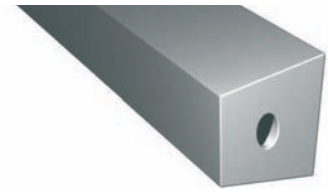

PVC / RUBBER  
length rolls 50 lm

Article	
M 233	*

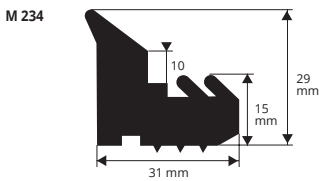

PVC / RUBBER - weight 650 g / lm  
length rolls 50 lm

Article	
M 234	*
M 234 A	*
M 234 B	*

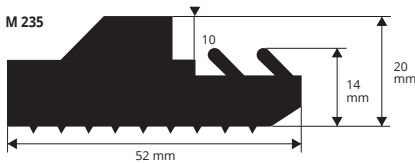
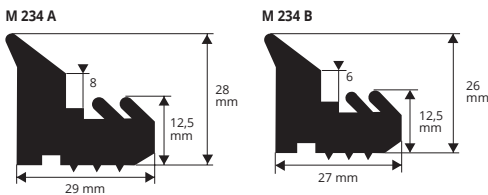
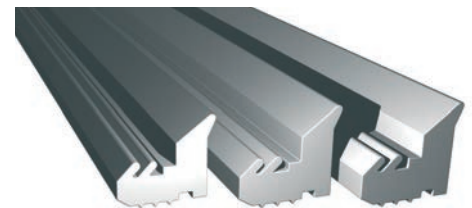

PVC / RUBBER - weight 980 g / lm  
length rolls 50 lm

Article	
M 235	*

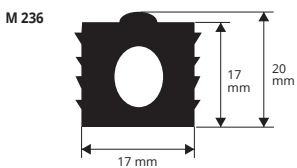

PVC / RUBBER - weight 270 g / lm  
length rolls 50 lm

Article	
M 236	*
M 236 A	*
M 236 B	*

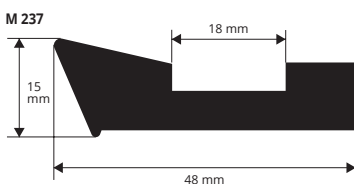
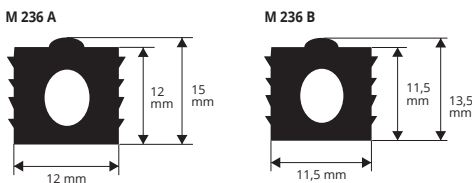

PVC / RUBBER - weight 510 g / lm  
length rolls 50 lm

Article	
M 237	*

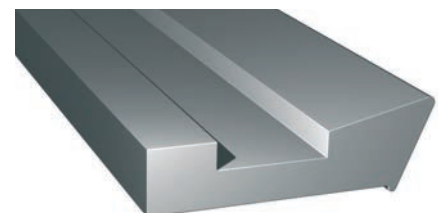

\* = Production on demand with minimum quantity of 50 lm. Production delay 4/5 weeks. Price to be agreed.

# GASKETS FOR PRECAST FORMS

PVC / RUBBER

gaskets for industrial precast forms

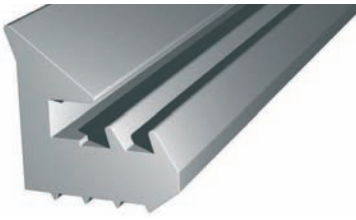

PVC / RUBBER - weight 695 g / lm  
length rolls 50 lm

Article	
M 238	*

M 238

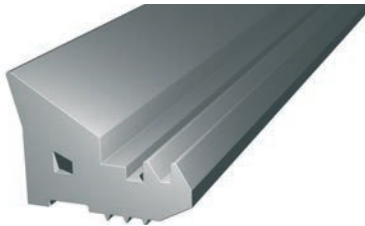
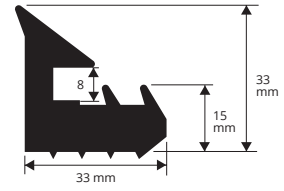

PVC / RUBBER - weight 880 g / lm  
length rolls 50 lm

Article	
M 239	*

M 239

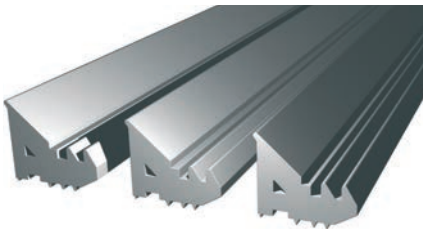
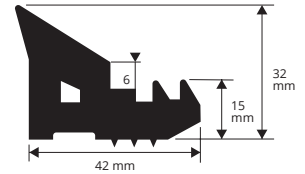

PVC / RUBBER  
length rolls 50 lm

Article	
M 240	*
M 240 A	*
M 240 B	*

M 240

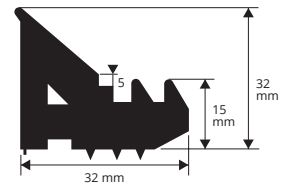

M 240 A

M 240 B

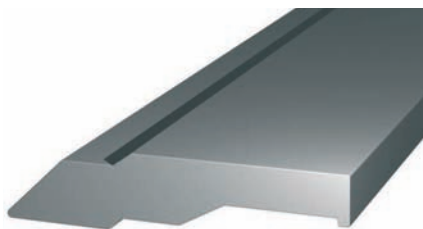
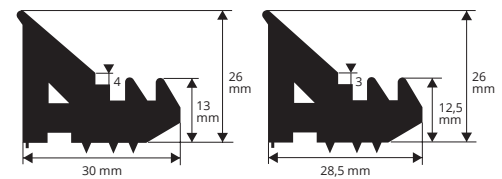

PVC / RUBBER  
length rolls 50 lm

Article	
M 241	*

M 241

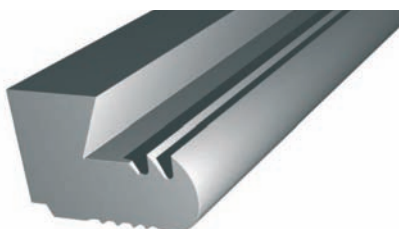
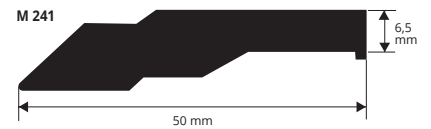

PVC / RUBBER - weight 695 g / lm  
length rolls 50 lm

Article	
M 242	*

M 242

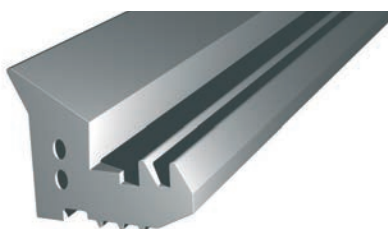
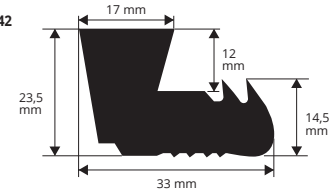

PVC / RUBBER - weight 630 g / lm  
length rolls 50 lm

Article	
M 243	*

M 243

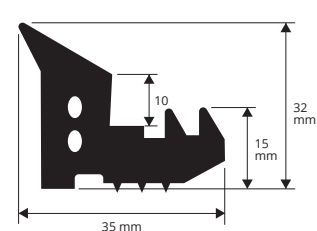

\* = Production on demand with minimum quantity of 50 lm. Production delay 4/5 weeks. Price to be agreed.

# GASKETS FOR PRECAST FORMS

PVC / RUBBER

gaskets for industrial precast forms

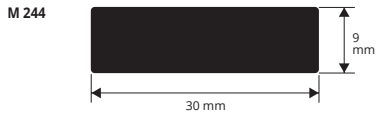

PVC / RUBBER - weight 180-330 g / lm  
length rolls 50 lm

Article	
M 244	*
M 244 A	*

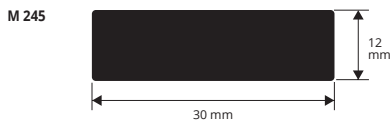

PVC / RUBBER  
length rolls 50 lm

Article	
M 245	*

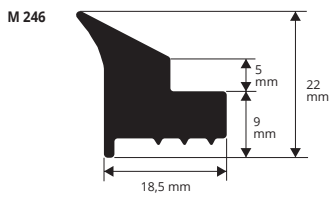

PVC / RUBBER - weight 330 g / lm  
length rolls 50 lm

Article	
M 246	*

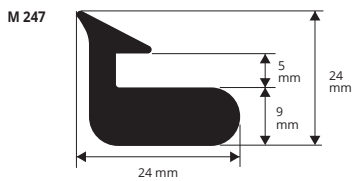
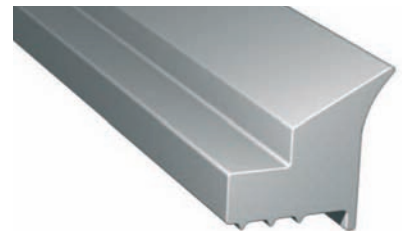

PVC / RUBBER - weight 335 g / lm  
length rolls 50 lm

Article	
M 247	*

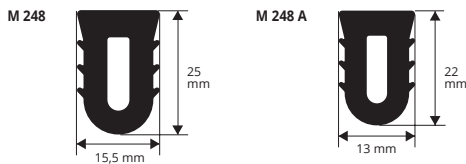

PVC / RUBBER - weight 270 g / lm  
length rolls 50 lm

Article	
M 248	*
M 248 A	*

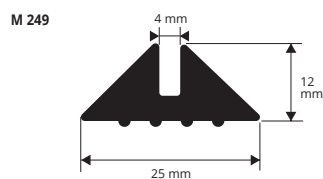

PVC / RUBBER - weight 220 g / lm  
length rolls 50 lm

Article	
M 249	*



\* = Production on demand with minimum quantity of 50 lm. Production delay 4/5 weeks. Price to be agreed.



# GASKETS FOR PRECAST FORMS

PVC / RUBBER

gaskets for industrial precast forms



PVC / RUBBER  
length rolls 50 lm

Article  \*

M 250

M 250

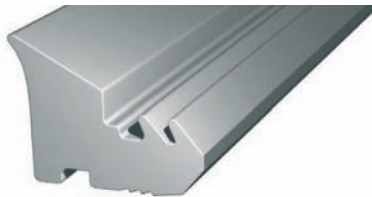
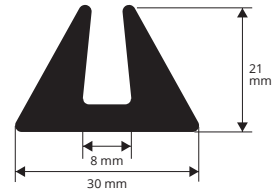

PVC / RUBBER  
length rolls 50 lm

Article  \*

M 251

M 251

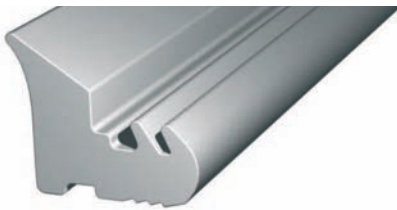
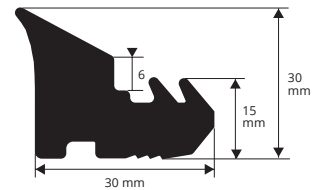

PVC / RUBBER  
length rolls 50 Lm

Article  \*

M 252

M 252

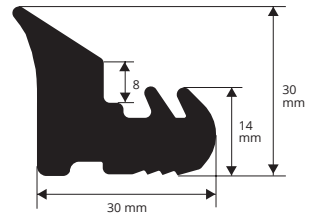

PVC / RUBBER  
length rolls 50 Lm

Article  \*

M 253

M 253

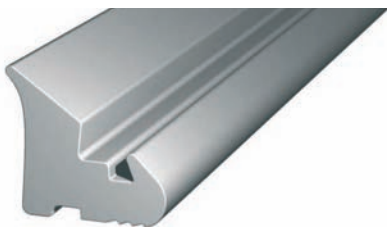
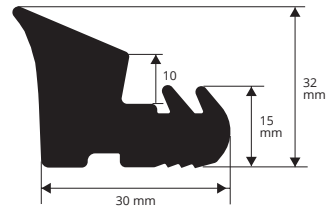

PVC / RUBBER  
length rolls 50 lm

Article  \*

M 254

M 254

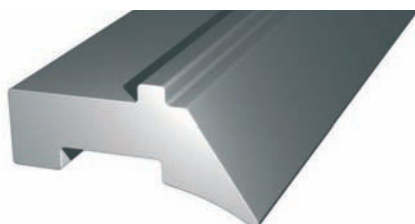
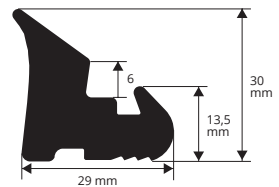

PVC / RUBBER  
length rolls 50 lm

Article  \*

M 255

M 255

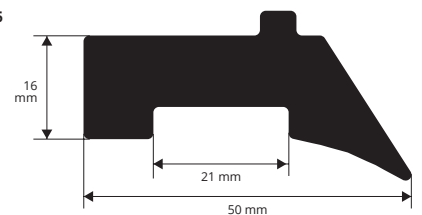

\* = Production on demand with minimum quantity of 50 lm. Production delay 4/5 weeks. Price to be agreed.

# GASKETS FOR PRECAST FORMS

PVC / RUBBER

gaskets for industrial precast forms

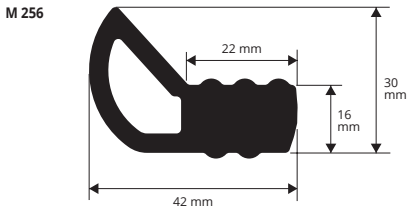

PVC / RUBBER  
length rolls 50 lm

Article	
M 256	*

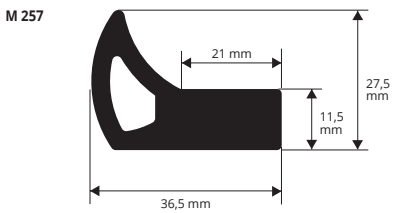
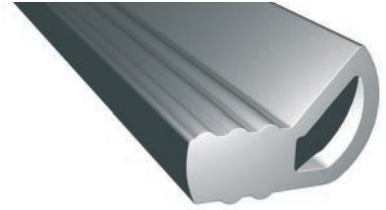

PVC / RUBBER  
length rolls 50 lm

Article	
M 257	*

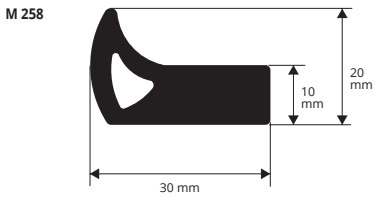
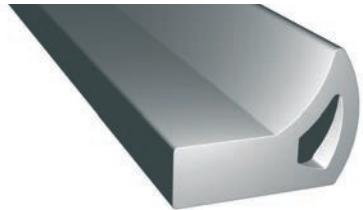

PVC / RUBBER  
length rolls 50 lm

Article	
M 258	*

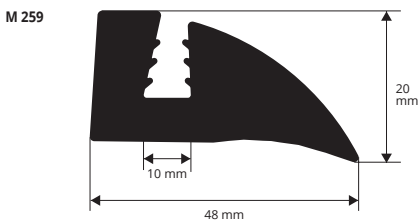
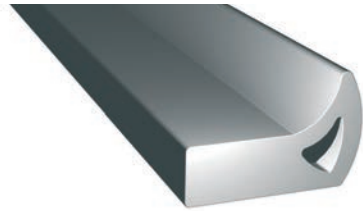

PVC / RUBBER - weight 750 g / lm  
length rolls 50 lm

Article	
M 259	*

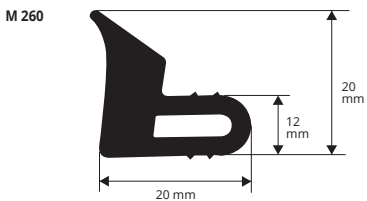

PVC / RUBBER - weight 350 g / lm  
length rolls 50 lm

Article	
M 260	*

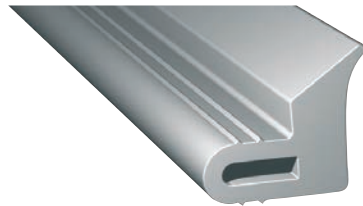

\* = Production on demand with minimum quantity of 50 lm. Production delay 4/5 weeks. Price to be agreed.

# GAP-COVERING BALLOON SHEATH

COEXTRUDED FLEXIBLE VINYL RESIN

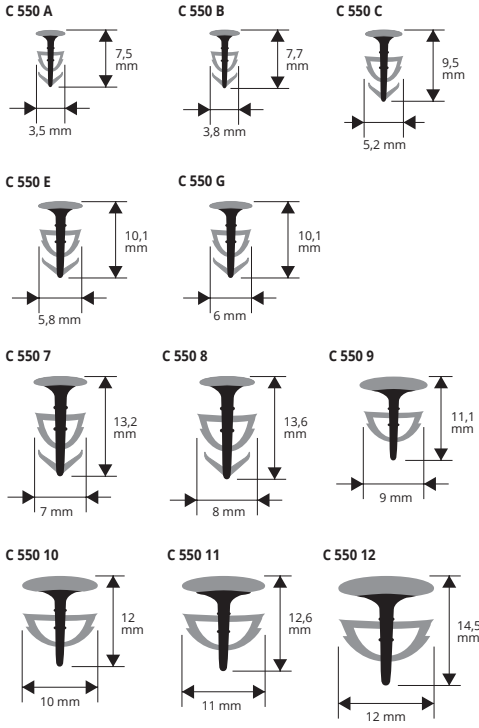
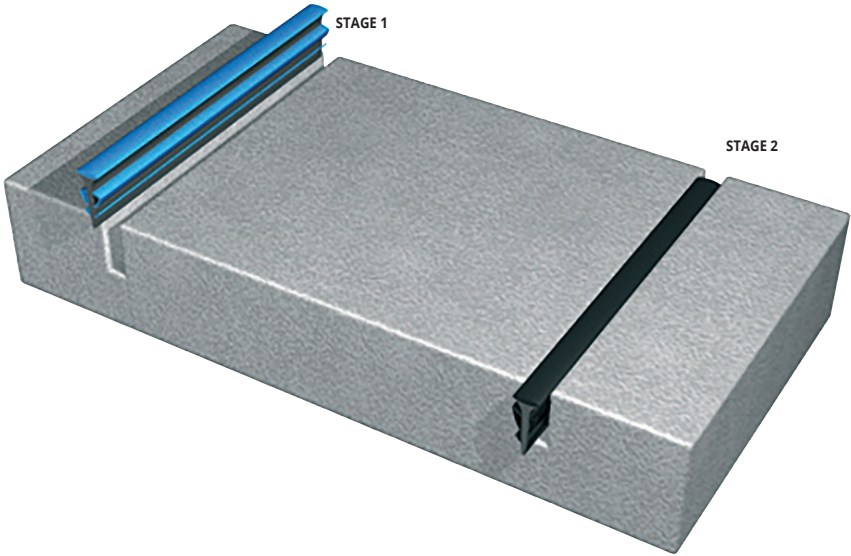

**For industrial floors - FLEXIBLE VINYL RESIN**

pack. roll 250 lm

Article	sheath L mm	disk thick mm		
C 550 A..	3,5	2,4		*
C 550 B..	3,8	2,8		*
C 550 C..	5,2	3,2		*
C 550 E..	5,8	3,6/3,8		*
C 550 G..	6	4,2		*

MINIMUM QUANTITY 20 ROLLS = 5000 lm per colour and dimension.  
Available for every type of diamond and abrasive disk.

**For larger gaps - FLEXIBLE VINYL RESIN**

pack. roll 200 lm

Article	sheath L mm	disk thick mm		
C 550 7..	7	5/6		*
C 550 8..	8	6/7		*

**For larger gaps - FLEXIBLE VINYL RESIN**

pack. roll 150 lm

Article	sheath L mm	disk thick mm		
C 550 9..	9	7/8		*
C 550 10..	10	8/9		*

**For larger gaps - FLEXIBLE VINYL RESIN**

pack. roll 100 lm

Article	sheath L mm	disk thick mm		
C 550 11..	11	9/10		*
C 550 12..	12	10/11		*

The inserted joints have a wider upper flat part to cover the splintering of the floor created by the disk during cutting.

Available in the colours: G - Y - R - N - B. The code of the selected colour must be added to the article code. E.g.: C 550 A.. (chosen colour Grey) C 550 AG.

**COLOURS**



**RESOLVES THE FOLLOWING PROBLEMS:**

- Perfectly covers the gap made with any type of disk and remains for a long time at floor level without sinking.
- Thanks to the central semi-rigid shank, the sheath cannot contract in the joint areas.
- When the disk is worn, the sheath need not be changed because it adapts to even the narrowest gaps.
- Also available for larger gaps from 6 mm to 12 mm.
- Very easy to lay.

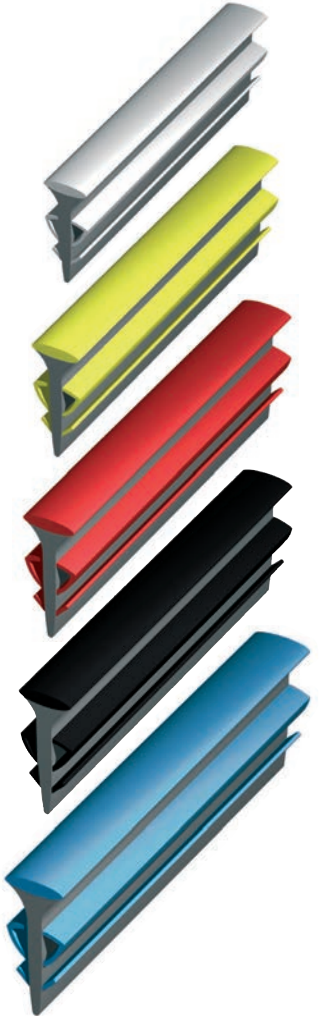

\* = Production on demand with minimum quantity of 5000 lm. Production delay 4/5 weeks. Price to be agreed.

# PAVIJOINT

GREY RIGID PVC

**PAVIJOINT** is a rigid PVC profile with the upper part in elastic PVC/rubber, which absorbs the stress of the floor movements. Two T-irons are inserted inside the profile to strengthen it and to unite two short rods; through holes are also made for the rods 80 cm apart. The **PAVIJOINT** totally replaces the conventional aluminium beams used for shuttering the concrete cast, thereby avoiding demoulding of the cast and cutting of the joint with diamond-slitting disks in a delicate point such as construction joints.

construction joints for industrial floors

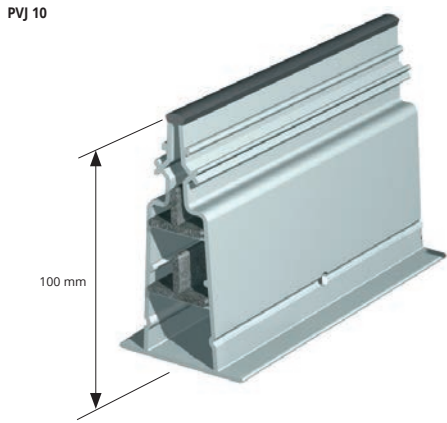

FLOOR TYPE OF LAYING:  
example of laying for heights between 15 and 20 mm

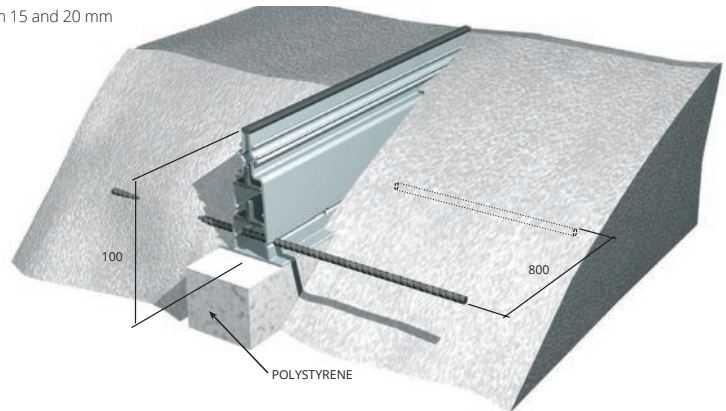

FLOOR SLAB TYPE OF LAYING:  
example of laying for height of 10 mm

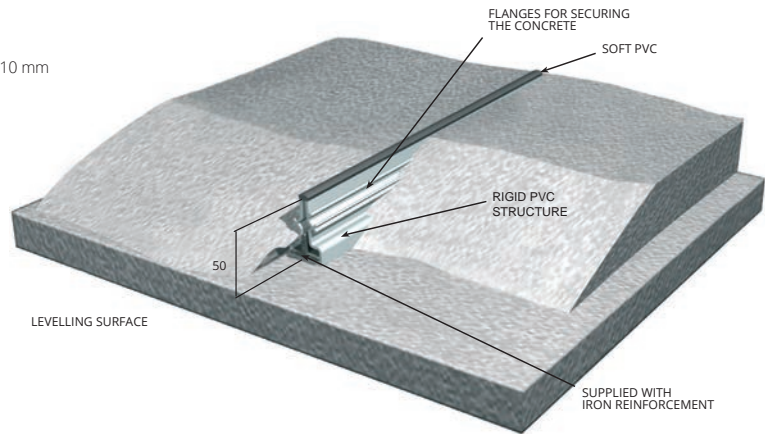

## COMPLETE PAVIJOINT - RIGID VINYL RESIN

bar length **3,10 lm**

Article	H mm
PVJ 10	100

## PHYSICAL-MECHANICAL CHARACTERISTICS OF RIGID PVC

PROPERTIES	U. M.	RESULTS	METHOD
Specific weight	gr/cm <sup>3</sup>	1.45 +/- 0.020	ASTM=D 792
Tensile yield strength	N/mm <sup>2</sup>	49	ASTM=D 638
Ultimate tensile stress	N/mm <sup>2</sup>	44	ASTM=D 638
Ultimate tensile stress	%	4%	ASTM=D 638
Flexural yield strength	N/mm <sup>2</sup>	94	ASTM=D 790
Flexing resistance	N/mm <sup>2</sup>	3240	ASTM=D 790
Impact strength	J/m a 23°C	44	ASTM=D 256
Softening temperature	Vicat°C	83 50N	ASTM=D 1525

## MECHANICAL CHARACTERISTICS OF SOFT PVC/RUBBER

PROPERTIES	U. M.	RESULTS	METHOD
Specific weight	gr/cm <sup>3</sup>	1.25 +/- 0.02	ISO 1183
Hardness	Sh A 15"	67 +/- 2	ISO 868
Ultimate tensile strength	N/mm <sup>2</sup>	> 16	ISO 527
Ultimate elongation	%	> 350	ISO 27

\* = Production on demand with minimum quantity of 100 lm. Production delay 4/5 weeks. Price to be agreed.

# LAYING ACCESSORIES

GREY RIGID PVC

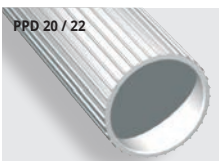

**RIBBED DISTANCE TUBE (to neutralise the short rods)**  
RIGID PVC - bar length 2 lm - pack. 20 Pcs - 50 lm

Article	Ø mm outside
PPD 20	20
PPD 22	22

**PLUGS FOR FINNED TUBE - GREY HD POLYETHYLENE**  
pack. 2000 Pcs divided in two 1000 Pcs bags

Article	Ø mm
PPT 20	20
PPT 22	22

**CORNER JOINTS FOR SECURING PAVIJOINT** - pack. 20 Pcs

Article
SQBD

\* = Production on demand with minimum quantity of 10000 pcs. Production delay 4/5 weeks. Price to be agreed.

The **SHEATH LAYING TROLLEY** was designed to lay different sizes of bubble sheathing easily and correctly. It is supplied with the accessories indicated in the photo (except for the pliers).

# SHEATH LAYING TROLLEY

## FOR INDUSTRIAL FLOORS

**SHEATH LAYING TROLLEY FOR INDUSTRIAL FLOORS**  
with accessories (extra weight - slurry dragger)

Article
CPGC



START OF LAYING



EASY TO USE



GROUT DRAGGER FOR MORE CONTROLLED LAYING



ROLL-LIFTING FEET



EXTRA WEIGHT



LIGHTWEIGHT FOR MOBILITY

Laying products

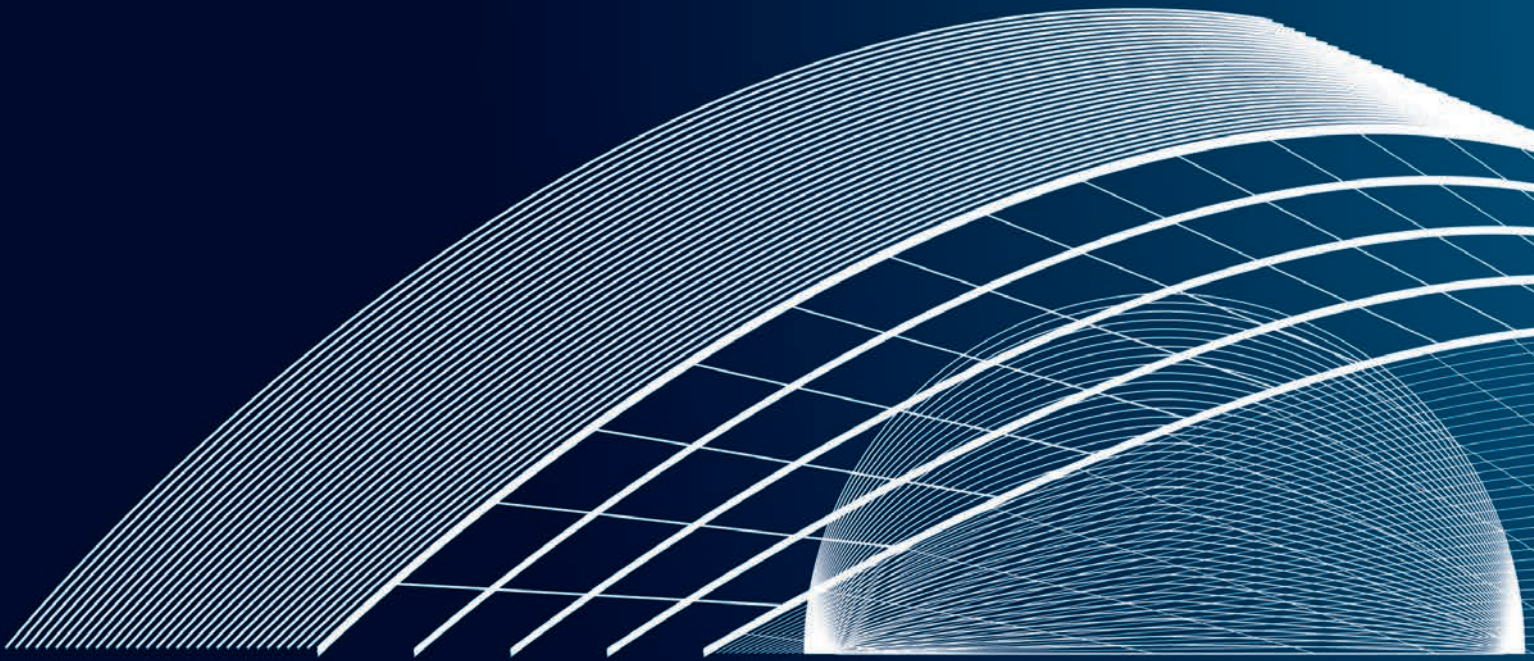

An interpretation of:  
**City of Art and Science, Santiago Calatrava, Valencia (Spain), 2009**

MARKETING AND SALES STAND SYSTEMS



# SQUARE SHOW CASE WITH DRAWERS FOR PROFILES FOR SHOW ROOM

SQUARE SHOW CASE WITH 10 DRAWERS  
length 39,5 cm - width 39,5 cm - height 109 cm  
(\*Brochure and flyers not included)

Article

ESPQCI



1 - Profiles for walls



2 - Profiles for walls



3 - Profiles for floors



4 - Profiles for floors



5 - Profiles for floors



6 - Profiles for floors + joints



7 - Stair nosing profiles



8 - Stair nosing profiles



9 - Terraces



10 - Skirting



11 - Skirting



12 - Profiles for parquet

## SET OF SAMPLES AVAILABLE FOR 10 DRAWERS

Set	Samples Description
1	<b>PROFILES FOR WALLS</b> - Projolly Triangle - Prointer - Proterminal Int - Prolistel Channel - Prolistel ACC, P ALL, Led - Profinlist 20 - Proedge AC, OT - Proround - Probord
2	<b>PROFILES FOR WALLS</b> - Proseal 50, 25 - Proshell - Proshell All - Prointer KL - Prokerlam SQ - Prokerlam Line - Prokerlam Jolly - Protap - Protap T - Proshell R, D
3	<b>PROFILES FOR FLOORS</b> - Proterminal Curve - Projolly Curve - Proslider Curve - Prolevigal - Proelegant - Profinal - Prosquare - Proangle - Projoint - Procanal - Profat
4	<b>PROFILES FOR FLOORS</b> - Proslider - Procarpet - Proslider LR - Proskid - Proskid ALL - Prolevall 29, 33, 305 - Pronivo - Protrans
5	<b>PROFILES FOR FLOORS</b> - Profloor - Proress - Proslider - Prolinoleoum - Procover - Promoquette Gin - Promoquette Clip - Promoquette - Promoquette Fix
6	<b>PROFILES FOR FLOORS + JOINTS</b> - Proplate - Prolevall 38 - Proflex - Proflex ALN - Prodilat - Mortar-laid Joints
7	<b>STAIR NOSING PROFILES</b> - Prostair - Prostyle - Prostyle Grip - Prostair - Prostair 50 - Probrastep - Probrastep - Protermstep ACC, ALL - Prostyle
8	<b>STAIR NOSING PROFILES</b> - Prostair Led - Prostep Ins - Prostyle KL - Prostair KL 20 - Prowalk - Proend Ins, Grip - Proend 50 - Proend - Tube 12 - Tube plugs 12 - Eyelet - Hinge support
9	<b>TERRACES</b> - Prot Terrace Drain - Prot Terrace PCG, ALT, pc, PCJ, ECO
10	<b>SKIRTING</b> - Proskirting INS, ISP - Punched support - Proskirting - Proskirting Shell, Led - Cable glands support - Polycarbonate flat - Proskirting Giled - Top Giled
11	<b>SKIRTING</b> - Skirting 40, 60, 100, 7016, 7011 - Support clip - Skirting 60 Flex - Covecap - Skirting
12	<b>PROFILES FOR PARQUET</b> - Proscrow Base - Proscrow 44, 33, 50 - Proinsert Base 45, 40 - Pin Insert - Top Sol 40 P, 30 P - Terminal Pin - Zero Curve - Style Stair - Style Stair L - Terminal - Base LVT 30, 23 - LVT Top, Terminal, Zero Curve

### NOTES:

Labels will be delivered with the profiles samples, but in a separated pack.

(\* ) Write the brochures and flyers codes of the systems to be displayed



# EXPOSURE DISPLAY / WALL UNIT FOR SHOWROOM



## EXPOSURE DISPLAY / WALL UNIT FOR SHOWROOM

W 208 cm x H 240 cm

Description	Article
<i>Exposure display / wall unit</i>	ESH PAN 250
<b>The exposure display / wall unit is complete with</b>	
19 Sample board PESP	PESP 1 + 19
1 Display PROLEVELING SYSTEM	PNPLSI
1 Bruchure display PROLEVELING SYSTEM	PBPLS
50 Flyer PROLEVELING SYSTEM	FLYPLSI 18
3 Finishes case:	
- PROJOLLY finishes case	COFPJ
- PROJOLLY SQUARE finishes case	COFPJQ
- PROTERMINAL finishes case	COFPT
2 Photo book	BOAM
1 Exposure display PROSHOWER with Design grid	PSHWDL 70 + PSHWD 70
1 Bruchures exposure	ESPB
3 Sample board PROLISTEL	PESPPLT - PESPLT15 - PESPLTP
3 Sample board SKIRTING	PESPBT - PESPPK - PESPPKCH
Description	Article
<i>Please order separately 10 brochures</i>	MCAT21/22I

## ROTATING DISPLAY EXPOSURE STAND FOR SHOW ROOM

ROTATING DISPLAY EXPOSURE STAND FOR SHOW ROOM  
(with 18 sample boards) - diameter 81 cm - height 224 cm

Article

ESPGSM18

The rotating display allows to exposed 18 removable boards with images of different settings.  
(On the order write the number of the 18 chosen boards PESP)  
The sample boards are 19. When the display is ordered, specify the desired 18 sample boards according to sales requirements.



## SMALL EXPOSURE STAND

SMALL EXPOSURE STAND (with 4 sample boards)  
width 33 cm - depth 50 cm - height 60 cm

Article

CURAS

It allows to expose 4 easily removable boards at your choice. (On the order write the number of the 4 chosen boards PESP) The sample boards are 19. When the stand is ordered, specify the desired 4 sample boards according to sales requirements.



## TROLLEY

TROLLEY (with 18 sample boards)  
width 50 cm - depth 35 cm - height 63 cm

Article

TRAG18

(On the order write the number of the 18 chosen boards PESP ...)



## PROLISTEL AND SKIRTING DISPLAY

PROLISTEL AND SKIRTING COUNTER DISPLAY

Article

ESPBLSH



PROLISTEL  
width 30 cm - height 38 cm

Article

PESPPLT

PESPPLT15

PESPPLTP

PESPPLT



PESPPLT15



PESPPLTP



SKIRTING  
width 30 cm - height 38 cm

Article

PESPBT

PESPCK

PESPCKCH

PESPBT

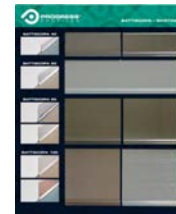

PESPCK

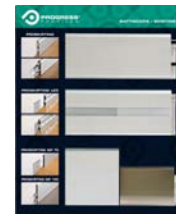

PESPCKCH



# SAMPLE BOARD

**SAMPLE BOARD**  
width 30 cm - height 56 cm

Article

PESP 1/ 2/ 3/ 4/ 5/ 6/ 7/ 8/ 9/ 10/ 11/ 12/ 13/ 14/ 15/  
16/ 17/ 18/ 19

For the composition of the display ESPGSM and CURAS, choose the boards you wish with the reference number.



**Sample board n° 1**  
Projolly Square, Profinlist,  
Prolistel, Procanal

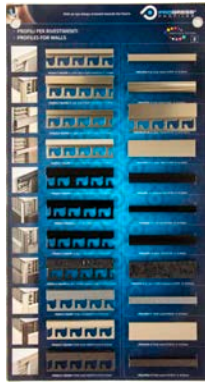

**Sample board n° 2**  
Projolly Square, Prolistel,  
Profinlist



**Sample board n° 3**  
Projolly, Projolly Quart,  
Proprinter, Proterminal



**Sample board n° 4**  
Probord, Proedge, Proshell,  
Prosguscio, Proround, Probatth,  
Proseal, Protrop, Prokerlam



**Sample board n° 5**  
Proterminal, Profinal,  
Proelegant, Provelgal, Procanal,  
Projoint, Proangle, Proflat



**Sample board n° 6**  
Proslider, Procarpet, Proskid,  
Proslider, Procover, Propress,  
Proplate

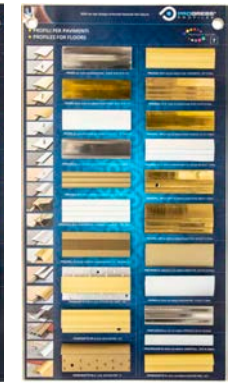

**Sample board n° 7**  
Prosol, Prolevall, Protrams,  
Pronivo, Promoquette, Proflor,  
Prolinoleum, Pronivo



**Sample board n° 8**  
Prostair, Prostyle, Prostep,  
Protermstep, Probrastep,



**Sample board n° 9**  
Prostyle, Prowalk, Proend,  
Prostair, Tube and Accessories

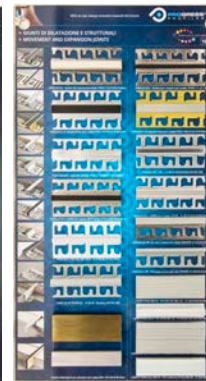

**Sample board n° 10**  
Proflex, Prodlit,  
Adhesive-laid Joint,  
Mortar-laid Joint



**Sample board n° 11**  
Proexpan, GNS, GDA,  
Proplate

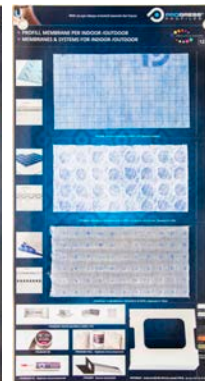

**Sample board n° 12**  
Profoil, Prodeso, Prodrain 10,  
Proband, Proband BU,  
Proband Koll, Proband Fix  
Prodrup, Proterrace



**Sample board n° 13**  
Proterrace



**Sample board n° 14**  
Skirting 40/ 60/ 80/ 100



**Sample board n° 15**  
Proskirting,  
Giled, Shell, Led, Flat, INS, ISP,  
Channel, Line



**Sample board n° 16**  
SOL 40P, Terminal Pin,  
Zero Curve,  
Style Stair, Terminal, SOL 30,  
Profixer Line, SOL 50, Proscrow



**Sample board n° 17**  
Curve Profiles - Proterminal,  
Projolly, Profinal, Proslider,  
Procover, Proelegant, Terminal  
Do it yourself profiles - Tube,  
Corner, Canal, Flat,  
Curve Profile



**Sample board n° 18**  
Triangular Chamfer,  
Rapy 100/200, Ribbed Distance,  
Rounded Triangular Chamfer,  
Prodistanz, Waterstop,  
Snake-on Strand, PAU/PAV  
spacers



**Sample board n° 19**  
Projolly Triangle, Proterminal Int,  
Prolistel channel, Proskirting 40,  
Skirting 7011/16, Proseal flex,  
Protrop T, Style stair L, Proside walk

## SAMPLE CASES

### FINISHES CASES

Article	Description
COFPJ	Projolly / Projolly Quart
COFPJQ	Projolly Square
COFPT	Proterminal
COFSTL	Stone Line
COFBT	Skirtings



## COLOUR RANGE KEYRINGS

### PROFILES COLOUR RANGE

Article	Description
COLBS	Skirtings
COLPJ	Projolly
COLPJM	Projolly marble
COLPJQ	Projolly square
COLPJT	Projolly quart



COLBS



COLPJ



COLPJM

## SAMPLES AND WOODEN

### PROFILES FOR LAMINATE, PARQUET AND CARPETED FLOORS

Article
TUBLAM (PROINSERT SYSTEM profiles samples)
CCOLL (standard wood samples)
CCOLLR (on demand wood samples) *



TUBLAM



CCOLLR



CCOLL

## PROSKIRTING GILED DISPLAY

PROSKIRTING GILED PANEL  
width 70 cm - height 92 cm

Article
ESPGLED



FRONT

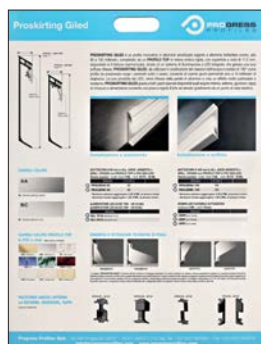

BACK

## PROSKIRTING LED DISPLAY

PROSKIRTING LED PANEL  
width 70 cm - height 92 cm

Article
ESPLED



SWITCHED OFF



SWITCHED ON



BACK OF PROSKIRTING LED BOARD

# PRODESO HEAT SYSTEM PRODESO SYSTEM

EXPOSURE PRODESO® HEAT SYSTEM  
width 60 cm - depth 60 cm - height 206 cm

Article

ESPPDHI595



EXPOSURE PRODESO® HEAT SYSTEM

Article

SPCPDESH...



MEMBRANES CASE

Article

COFM...



EXPOSURE PRODESO®

Article

SPCPDES...



EXPOSURE PRODESO® HEAT / PRODESO® / PROTERRACE  
width 60 cm - depth 60 cm - height 206 cm

Article

ESPPDHT...



# PROSHOWER SYSTEM DISPLAY

EXPOSURE DISPLAY PROSHOWER SYSTEM FOR SHOWROOM  
(with PROSHOWER BASE L + SET OF AVAILABLE GRIDS)  
width 100 cm x 36 cm - height 73 cm

Article

ESPSHW 70 + (COLGPSHW 70)



FRONT



BACK



SET OF AVAILABLE GRIDS

# PRODUCT BOARD PROLEVELING SYSTEM DISPLAY SPACERS

## PROLEVELING SYSTEM DISPLAY

Article

ESPPLS 50/70

## PROLEVELING SYSTEM BOARD - 2 PCS

Article

PNPLS...

## PROLEVELING SYSTEM BOARD

Article

PNPLSA3 (29,7 x 42 cm)

### PROLEVELING SYSTEM DISPLAY

7 COMPARTMENTS

5 COMPARTMENTS



### PROLEVELING WEDGE SYSTEM BOARD

Article

PNPLWS

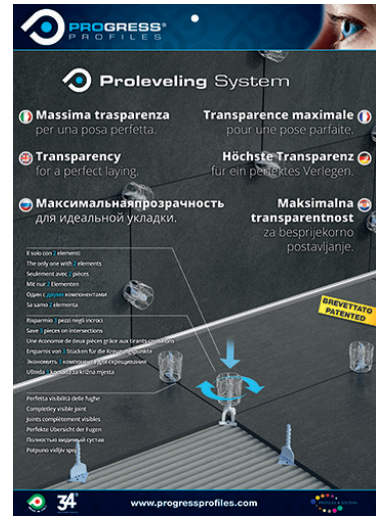

# SPACERS DISPLAY

## SPACERS DISPLAY (ACCESSORIES EXCLUDED)



## EXPOSURE DISPLAY DISTANZIATORI PROGRESS PROFILES

Article

ESPD

# EXHIBITION BOARD

EXHIBITION BOARD - 80 x 57 cm

Article

PNPSR (80 x 57 cm)



# EXPOSURE DISPLAY PROSUPPORT TUBE

EXPOSURE DISPLAY PROSUPPORT TUBE WITH 50 FLYER

Article

ESPPST

FLYPSUP...



# EXPOSURE DISPLAY PROTERRACE

EXPOSURE DISPLAY PROTERRACE WITH 50 FLYER

Article

ESPFDPP

FLYPTER...



## GENERAL CATALOGUE / PRICE LIST

Article	
CAT22...	



## BROCHURE A4 PRODESO DRAIN SYSTEM

Article	
BRPDDR...	



## BROCHURE A4 PRODESO HEAT GRIP SYSTEM

Article	
BRDESHG...	



## BROCHURE A4 PRODESO HEAT SYSTEM

Article	
BRDESH...	



## MINI CATALOGUE A5 (NO PRICES)

Article	
MCAT21/22...	



## BROCHURE A4 PRODESO SYSTEM

Article	
BRDES...	



## BROCHURE A4 PROSHOWER SYSTEM

Article	
BRPSW...	



## BROCHURE A4 PROSUPPORT TUBE SYSTEM

Article	
BRPSUPT...	



## COUNTER DISPLAY FOR BROCHURES

Article	
ESPB...	



## BROCHURE SYSTEMS

Article	
BRSYS 20/21	

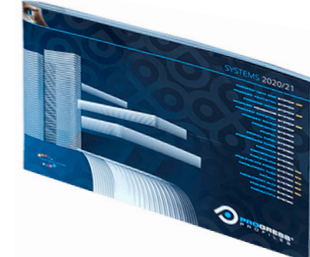

## PHOTO BOOK

Article	
BOAM	



## COUNTER DISPLAY FOR FLYER

Article	
PBPLS	



Order the customization sticker separately in line with the exposed flyer

## DEPLIANT FLYER 10 X 21 cm - Pack 50 Pcs

Article	Description
FLYPDDR...	Flyer Prodeso Drain system
FLYPDESHG...	Flyer Prodeso Heat Grip system
FLYPDES...	Flyer Prodeso Membrane system
FLYPSHW...	Flyer Proshower system
FLYPPFS...	Flyer Profoil panel system
FLYPTER...	Flyer Proterrace system
FLYPLS...	Flyer Proleveling system
FLYPSUP...	Flyer Prosupport tube system
FLYPLED...	Flyer Proledlight system
FLYPDSD...	Flyer Prodeso sound system
FLYPMPLTFX...	Flyer Promultifix system

## FLYPDDR...



## FLYPDESHG...



## FLYPDES...



## FLYPSHW...



## FLYPPFS...



## FLYPTER...



## FLYPLS...



## FLYPSUP...



## FLYPLED...



## FLYPDSD...

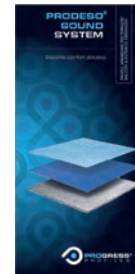

## FLYPMPLTFX...



Available in the following languages: Italian (I), English (E), German (T), French (F), Russian (R), Spanish (ES), American \$ (USA), English £ (UK). The initials of the chosen language must be added to the initials of the article.

Example: CAT22 ... (Desired language Italian) CAT22I;

# MODULAR DISPLAY SYSTEM FOR SHOWROOM

The **MODULAR DISPLAY SYSTEM WITH INTECHANGABLE BOARDS** is composed by an metal base, 225 cm height, 93 width and 44 cm deep. It is possible to fix to this framework boards with pictures, samples and fixing patterns of profiles. A shelf with a fixing example of the most common profiles showed on the boards above is in the middle of the framework. Thanks to the pictures of fixing patterns, profiles samples and fixinf examples, the modular display allows the customer to have an overall view of the use of the Progress Profiles products and systems. The modularity and the small size of the display allows its positioning in all showroom and sales point. Thanks to the modularity of the boards, the customer can choose the boards according to the products he wants to show. The system is easy to update with new finishes and products.



**MODULAR DISPLAY WITH VIDEO**

**MODULAR DISPLAY WITH STEPS**

## MODULAR DISPLAY SYSTEM

Article	Description	
RIV 1	Modular display Profiles for walls 1	*
RIV 2	Modular display Profiles for walls 2	*
RIV 3	Modular display Profiles for walls 3	*
PAV1	Modular display Profiles for floors 1	*
PAV2	Modular display Profiles for floors 2	*
CRV	Modular display Curved profiles	*
GR1	Modular display Stair nosing profiles 1	*
GR2	Modular display Stair nosing profiles 2	*
GIU1	Modular display Joints 1	*
PTR	Modular display Prot Terrace	*
PSH1	Modular display Proshower 1	*
PSH2	Modular display Proshower 2	*
PFPG	Modular display Profoil panel	*
B1	Modular display Baseboards 1	*
B2	Modular display Baseboards 2	*
LED	Modular display Proedlight	*
LGN	Modular display Profiles for parquet	*
PLV	Modular display Proleveling	*
PSPT	Modular display Prosupport tube	*
PSTS	Modular display Prosupport slim/prorail	*



**RIV 1:**  
Projolly quart,  
Projolly angle,  
Projolly angle 135,  
Prolistel p,  
Proterminal,  
Prolistel,  
Prolistel channel,  
Profinlist,  
Proterminal int;



**RIV 2:**  
Projolly square;



**RIV 3:**  
Projolly,  
Printer,  
Printer kl,  
Proshell,  
Proedge,  
Prokerlam square,  
Prokerlam jolly,  
Prokerlam line,  
Prostair kl;



**PAV 1:**  
Proslider,  
Procarpet,  
Proskid,  
Profinal,  
Procanal,  
Projoint,  
Proterminal,  
Prolevigal,  
Proelegant;



**PAV 2:**  
Procover,  
Propress,  
Profloor,  
Prosol,  
Proplate,  
Prolevall,  
Promoquette;

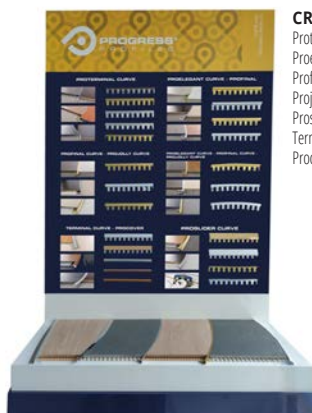

**CRV:**  
Proterminal curve,  
Proelegant curve,  
Profinal curve,  
Projolly curve,  
Proslider curve,  
Terminal curve,  
Procover;



**GR1:**  
Prostair acc,  
Prostair kl,  
Prostair grip,  
Prostair wood,  
Protermstep,  
Prostyle,  
Prostyle kl,  
Probrastep,  
Prostep;



**GR2:**  
Prostyle grip,  
Prostyle 2610,  
Proend ins,  
Proend grip,  
Prowalk,  
Prostair led,  
Proside walk;

\* = Article on demand, Production delay and prices to be agreed.



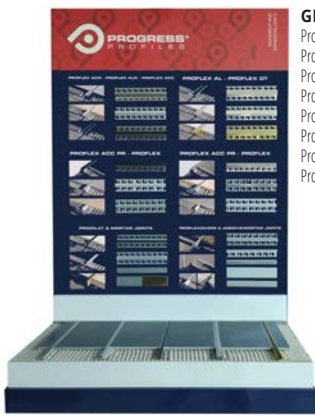

**GIU:**  
 Proflex acn  
 Proflex acc  
 Proflex aln,  
 Proflex al,  
 Proflex ot,  
 Proflex acc pr,  
 Proflex 25/5 pr,  
 Prodilat;



**PTR:**  
 Prot Terrace drain drip,  
 Prot Terrace drain fdp,  
 Prot Terrace pcg,  
 Prot Terrace pc,  
 Prot Terrace pcj,  
 Prot Terrace eco drip;



**PSH 1:**  
 Proshower linear system,  
 Proshower profile glass,  
 Proshower profile,  
 Proshower profile wall,  
 Proshower profile front;



**PSH2:**  
 Proshower central system



**PFPFG:**  
 PROFOIL PANEL SYSTEM,  
 PRO GOBORD SYSTEM,  
 PROFOIL PANEL NICHE,



**B1:**  
 Proskirting led,  
 Proskirting giled,  
 Proskirting list,  
 Proskirting isp,  
 Proskirting,  
 Proskirting shell,  
 Proskirting channel,  
 Proskirting flat,  
 Proskirting ins,  
 Proskirting line;

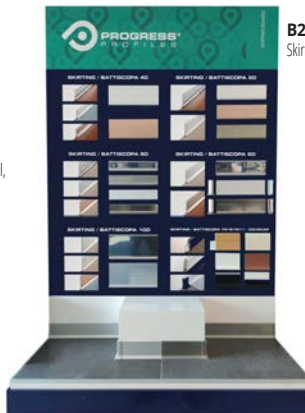

**B2:**  
 Skirtings



**LED:**  
 Proledlight system,  
 Proskirting led,  
 Proskirting giled,  
 Prostair led,  
 Prolistel led;



**LGN:**  
 Lvt Profiles,  
 Skirting 7016  
 Promuliftx,  
 Zero Curve,  
 Sol 40p,  
 Terminal Pin,  
 Style Stair;



**PLV:**  
 Proleveling System,  
 Proleveling Wedge  
 System;



**PSPT:**  
 Prosupport Tube,  
 Prosupport Profile;



**PSTS:**  
 Prosupport Slim,  
 Prorail System;



# SHOWROOM SET-UP EXAMPLES



PROPOSALS OF SHOWROOM EQUIPMENT - PROPOSAL 1 - Back - panels and desks are not included  
DISPLAYS FOR PROFILES ARE AVAILABLE UNDER CUSTOMER REQUEST

Description	Article
Rotating display stand + Sample boards (x18)	ESPGSM18 + PESP...
Counter display for flyer + Proleveling system flyer	PBPLS + FLYPLS 20
Proleveling System Board	PNPLS
Prot Terrace Display	ESPFDP
Counter display for mini catalogues	ESPB
Membrane case	COFM
Photo book	BOAM



PROPOSALS OF SHOWROOM EQUIPMENT - PROPOSAL 2 - Back - panels and desks are not included  
DISPLAYS FOR PROFILES ARE AVAILABLE UNDER CUSTOMER REQUEST

Description	Article
Exposure Display / Wall unit	ESHPAN 250
Proshower system display + available grids set	ESPSHW 70 + COLGPSHW70
Exhibition Board	PNPSR
Photo Book	BOAM
Proleveling system Sample Board	PNPLS



PROPOSALS OF SHOWROOM EQUIPMENT - PROPOSAL 3 - Back - panels and desks are not included  
DISPLAYS FOR PROFILES ARE AVAILABLE UNDER CUSTOMER REQUEST

Description	Article
Exposure Display / Wall unit	ESHPAN 250
Square show case with drawers for profiles custom displays and expositors	ESPQC



PROPOSALS OF SHOWROOM EQUIPMENT - PROPOSAL 4 - Back - panels and desks are not included  
DISPLAYS FOR PROFILES ARE AVAILABLE UNDER CUSTOMER REQUEST

Description	Article
Exposure Display / Wall unit	ESHPAN 250
Square show case with drawers for profiles	ESPQC



ESPV1N



ESPV2

## PROPOSALS OF SHOWROOM EQUIPMENT - PROPOSAL 5

Panels, samples and boxes excluded - NEUTRAL DISPLAY BOX WITH PROGRESS PROFILES UP BAND

Article	Dimensions
ESPV1N	225x183x60 cm

## PROPOSALS OF SHOWROOM EQUIPMENT - PROPOSAL 7

Panels, samples and boxes excluded - DISPLAY BOX WITH PROGRESS PROFILES COMPANY GRAPHICS

Article	Dimensions
ESPV2	225x183x60 cm

# PROPOSALS OF SHOWROOM EQUIPMENT

EXAMPLE OF CUSTOMIZED SHOWROOM SET-UP - 1



EXAMPLE OF CUSTOMIZED SHOWROOM SET-UP - 2



EXAMPLE OF CUSTOMIZED SHOWROOM SET-UP - 3



EXAMPLE OF CUSTOMIZED SHOWROOM SET-UP - 4



EXAMPLE OF CUSTOMIZED SHOWROOM SET-UP - 5



EXAMPLE OF CUSTOMIZED SHOWROOM SET-UP - 6





# DISPLAYS FOR PROFILES

**PEPCP** EXPOSURE DISPLAY "PEPCP" (accessories excluded)  
width 100 cm - depth 50 cm - height 230 cm

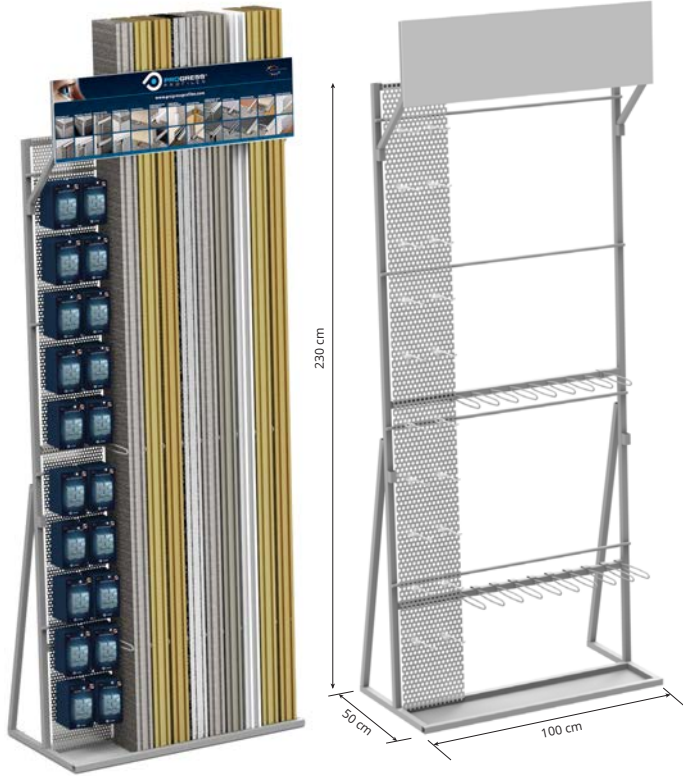
Article	
 PEPCP (profiles)	*
 PEPCPBT (skirtings)	*





**PEP** EXPOSURE DISPLAY PEP (accessories excluded)  
width 100 cm - depth 50 cm - height 230 cm

Article	
 PEP (profiles)	
 PEPBT (skirtings)	*



**PEPCPSP** EXPOSURE DISPLAY PEPCPSP (accessories excluded)  
width 100 cm - depth 50 cm - height 230 cm

Article	
 PEPCPSP (profiles)	*
 PEPCPSPBT (skirtings)	*



**PEPSP** EXPOSURE DISPLAY PEPSP (accessories excluded)  
width 100 cm - depth 50 cm - height 230 cm

Article	
 PEPSP (profiles)	*
 PEPSPBT (skirtings)	*



 = News 2021

 = Article on demand, Production delay and prices to be agreed.

# DISPLAYS FOR PROFILES

**ESPSP** EXPOSURE DISPLAY ESPSP (accessories excluded)  
width 100 cm - depth 75 cm - height 240 cm

Article
ESPSP



**PEPINSP** EXPOSURE DISPLAY PEPINSP (accessories excluded)  
width 100 cm - depth 50 cm - height 230 cm

Article
PEPINSP



**PEM** EXPOSURE DISPLAY PEM (ACCESSORIES EXCLUDED)  
width 120 cm - depth 61 cm - height 160 cm

Article
PEM



**PEPINS** EXPOSURE DISPLAY PEPINS (accessories excluded)  
width 100 cm - depth 50 cm - height 230 cm

Article
---------

- PEPINS (profiles)
- PEPINSBT (skirtings) \*

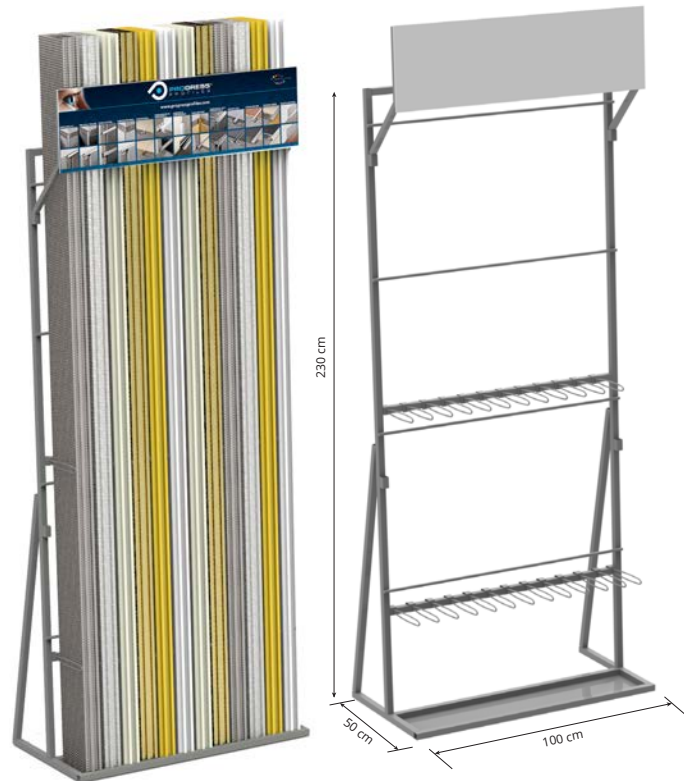

= News 2021

\* = Article on demand, Production delay and prices to be agreed.

# DISPLAYS FOR PROFILES

**ESPF** EXPOSURE DISPLAY ESPF (accessories excluded)  
width 65 cm - depth 20 cm - height 112 cm

Article
ESPF



**ESPF 2** EXPOSURE DISPLAY ESPF 2 (accessories excluded)  
width 65 cm - depth 40 cm - height 112 cm

Article
ESPF 2

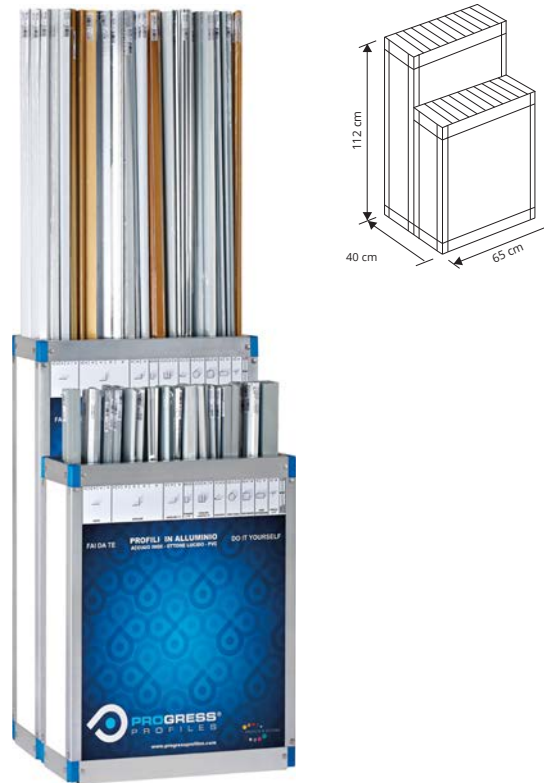

**ESPF 2015** EXPOSURE DISPLAY ESPF 2015 (accessories excluded)  
width 100 cm - depth 28 cm - height 81 cm

Article
ESPF 2015



**ESPF 2 2015** EXPOSURE DISPLAY ESPF 2 2015 (accessories excluded)  
width 100 cm - depth 56 cm - height 81 cm

Article
ESPF 2 2015



## GADGETS

Article	Description
<b>PEN</b>	Pen
<b>CUTTER</b>	Cutter
<b>FOGLAPP</b>	Post It
<b>PENCIL</b>	Work pencil
<b>TAPMOUSE</b>	Mousepad
<b>CARTPBPP</b>	Portfolio
<b>USB</b>	USB Pendrive
<b>FLESSOMETRO</b>	Tape
<b>CAP</b>	Baseball cap
<b>MARSUPIO BASIC</b>	Pouch
<b>PRGS10</b>	Profile measurement ruler
<b>OMBRELLOP</b>	Umbrella
<b>PLAN</b>	Planning
<b>PENNA DA BANCO</b>	Counter pen
<b>PENNA TECNICA</b>	Technical Pen



## T-SHIRT

Article	Description
<b>TSHIRT S</b>	T-shirt white S
<b>TSHIRT M</b>	T-shirt white M
<b>TSHIRT L</b>	T-shirt white L
<b>TSHIRT XL</b>	T-shirt white XL
<b>TSHIRT XXL</b>	T-shirt white XXL



## WHITE POLO

Article	Description
<b>POLOB M</b>	polo stretch wwhite M
<b>POLOB L</b>	polo stretch white L
<b>POLOB XL</b>	polo stretch white XL
<b>POLOB XXL</b>	polo stretch white XXL



## BLUE NAVY POLO

Article	Description
<b>POLOBMM</b>	polo stretch wwhite M
<b>POLOBN L</b>	polo stretch blu navy L
<b>POLOBN XL</b>	polo stretch blu navy XL
<b>POLOBN XXL</b>	polo stretch blu navy XXL



## GILET PROGRESS PROFILES

Article	Description
<b>GILET</b>	Vest



## PILE PROGRESS PROFILES

Article	Description
<b>PILE</b>	Fleece sweatshirt



# GENERAL TERMS AND CONDITIONS OF SALES PROGRESS PROFILES S.P.A.

These general terms and conditions (hereafter "General Terms and Conditions of Sales") govern the contractual relationships of the products manufactured or marketed (hereafter "Product/s" or "Good/s") by the company PROGRESS PROFILES S.P.A. (hereafter "Vendor") to its customers (hereafter individually "Buyer" or "Customer") (Buyer and Vendor also referred to jointly as "Parties" and individually as "Party"). These General Terms and Conditions of Sales do not apply to sales to consumers.

## 1) EFFECTIVENESS OF THE GENERAL TERMS AND CONDITIONS

These General Terms and Conditions of Sales apply even if not explicitly referred to and signed in individual orders. Any provisions in derogation of the requirements herein shall be effective only if expressly accepted in writing by the Parties. Any general terms and conditions of the Customer will not apply, even partially, unless they have been expressly accepted in writing by the Vendor. These General Terms Conditions of Sales are effective until they have been expressly revoked by the Vendor or are replaced by new terms and conditions that will become effective from their signing.

## 2) ORDER

The Goods object of each sale between the Buyer and the Vendor are described in the purchase order ("Order") that the Buyer sends directly or indirectly through its representatives to the Vendor. The Order is considered irrevocable for the Buyer if confirmed by the Vendor through the Order Confirmation, preform invoice.

## 3) CONTRACT

The sales contract of the Goods ("Contract") is governed by the Order, by the Order Confirmation and these General Terms and Conditions. The sending of an Order by the Customer implies his/her full acceptance of these General Terms and Conditions of sales and of any of the specific ones related to the Order itself. The Contract is completed with the acceptance of the Order by Order Confirmation, communicated in writing by the Vendor to the Buyer or, failing that, with the execution of the Order by delivering the Goods to the carrier or forwarder. Any changes to the Contract, proposed by the Buyer, will result in changes to the same only if accepted in writing by the Vendor.

## 4) DELIVERY TERMS, TRANSPORT OF GOODS

The delivery terms of the Goods will be agreed from time to time in the individual Order and relative Order Confirmation. The delivery terms must always be considered indicative, not essential, and are not binding for the Vendor. Any variations requested in the production phase, nonetheless relieve the Vendor from complying with the agreed terms. In this case the terms and conditions of delivery will be renegotiated. If the Buyer expressly requests an express delivery service in the Order, the Vendor will indicate, in the Order Confirmation the cost for this service which shall be considered accepted, if not contested in writing by the Buyer to the Vendor. Any reference to delivery terms (e.g. EX WORKS, CIF, FOB and others) contained in the Order and in the Order Confirmation refers to the Incoterms® of the International Chamber of Commerce, in the text in force on the date of the Order Confirmation. If a sale has been agreed with transport via carrier, regardless of the Party that appoints the carrier, the risks are transferred to the Customer with the delivery of the Goods to the first carrier: any claims for breakages, deterioration, tampering or deficiencies must be reported by Buyer to the carrier in accordance with the law, providing the Vendor with appropriate information. The Vendor is therefore entitled to reasonably anticipate or postpone the delivery of all or part of the Goods, without this entitling the Buyer to request full or partial termination of the Sales Contract or to claim compensation or indemnity and without the Buyer refusing delivery of the Goods. We shall not be liable for any delays in shipments which will not entitle the Customer to claim damages and/or penalties, to delay payments or reject the Goods. It is understood, however, that maximum effort shall be ensured in the execution of the Order on the agreed dates.

## 5) FORCE MAJEURE

The occurrence of causes not dependent on the will of the Parties, such as strikes of any kind, earthquakes, fires, floods, lack of motive power or energy, lack or scarcity of raw materials, breakdowns and breakages at the Vendor's production facilities, delays in granting authorizations by the Authorities, embargo or other measures of national or supranational Authorities and other impediments independent of the will of the Parties, which make delivery temporarily impossible or excessively expensive, the delivery time will be extended by a period equal to the duration of the impediment, the Party, upon becoming aware of the impediment, will communicate within a reasonable time to the other Party the existence of the impediment and, where this is not already implicit in the type of impediment, the probable effects it shall have on the delivery obligation. Similarly, the Party will inform the other Party of the removal of the impediment. It is understood that neither the Customer nor the Vendor can demand compensation or indemnity of any kind due to the occurrence of the circumstances provided for in article 5.

## 6) REFUSAL TO RECEIVE DELIVERY

Where the Buyer refuses to receive the delivery of all or part of the Goods only, the Vendor may, at its own unquestionable choice, demand performance of the Contract, or declare its total or partial termination. In either case, the Vendor retains the right to claim compensation for damages. Any responsibility of the Vendor for risks and costs deriving from or inherent to the stock of the Goods is expressly excluded, which shall be entirely charged to the Buyer.

## 7) DESCRIPTIVE DRAWINGS AND DOCUMENTS

The dimensions, sections, drawings, colours, finishes, prices and the other data included in the catalogues, prospectuses, circulars, advertisements, illustrations and price lists of the Vendor are approximate indications. These data is not binding except to the extent that they are expressly provided for in the Order Confirmation or in the Contract. Any photographs included in the offer and/or the Vendor's Order Confirmation are not binding and are for illustrative purposes only.

## 8) PRICES, PAYMENTS AND DEFINITION OF DEFAULT INTERESTS

The prices of the products are those indicated in the price list or on each offer made by the Seller with net prices. Such prices shall be determined on the basis of the price list in force when the order shall be taken in charge and processed by the Seller and shall be clearly indicated on the order confirmation. The prices of the products do not include any taxes or duties whatsoever, and are always Ex Works and do not include any installation or transport. Payments must be made by the Customer as specified and within the times indicated on the order confirmation. Orders for an amount less than € 100.00 shall not be fulfilled, or alternatively their value shall be increased by processing and handling costs. Orders for an amount less than Eur 300.00 shall also be increased by ancillary costs as shown on the "transport cost charges" chart in the Progress Profiles catalogue in the related section. For late payments, default interests shall be charged at the rate established by Italian Legislative Decree no. 231/2002 and subsequent amendments and / or additions, and shall apply from the first day after the expiry of the payment deadline. It is understood however that for any complaints or disputes the Customer is not entitled to suspend or, in all cases, delay payments for the Products subject of the claim, or any other supplies. More generally, no action or exception may be taken or opposed by the Customer unless after the full payment of the Products for which this dispute or exception is referred to. Furthermore, the Customer is not authorized to make any deductions from the agreed price (eg in the case of alleged defects in the Products), unless previously agreed in writing with the Seller.

## 9) SUSPENSION OF PERFORMANCE AND TERMINATION

The non-payment, even partial, of supplies or any amount due by the Buyer, or the total or partial non-fulfillment of contractual obligations or agreed conditions for the supply, automatically authorizes the Vendor to suspend further shipments or cancel any Orders in progress, or to subordinate the delivery of the Products to the provision of adequate guarantees of payment, and exonerate the Vendor from any ongoing commitment with the same Customer at any time and without prior notice. The Vendor has a similar right whenever changes occur to the Buyer, in its structure or corporate structure, in the composition of its governing or management bodies, in its financial situation, equity or commercial image, as well as in the case of lodging or submission of proof of debt in bankruptcy, pending enforcement or precautionary procedures, suspensions, difficulties or delays in the performance of obligations assumed, including to third parties, of facts referring to the Buyer that may be detrimental to the successful completion of the Contract and/or detrimental to commercial interests of the Vendor.

## 10) CHANGES - CONFORMITY

The Vendor reserves the right to make non-decisive changes to models, measures, materials always within the tolerances of use and without obligation of communication to the Buyer by sending the Order, the Customer declares to have verified that the Goods described in the Order comply with any legal, regulatory or administrative provisions in force in their country or in another country of destination of the Goods, applicable to the import, sale and use of the Goods. In no case will the Vendor be held responsible for any non-compliance with these legal provisions, regulations or administrative provisions. It is the Buyer's obligation to indicate to the Vendor in the Order any provision of law or regulation and/or any standard applicable to the Goods ordered if different from those applicable in Italy and/or indicated in the Vendor's Offer. In this case, the prices of the Goods will not be those indicated in article 8, but will be agreed between the Parties for each supply. It is understood that, in the absence of such indications, the Vendor will not be in any way responsible for the non-compliance or non-conformity of the Goods supplied to laws, regulations, standards or administrative provisions and the Buyer shall be obliged to keep the Vendor indemnified from any damage or claim that the Vendor, or its staff or administrators, may suffer, even against claims made by third parties, due to such shortcomings.

## 11) WARRANTY AND LIMITS

In the terms provided for in article 11, the Vendor undertakes to deliver the Products as agreed and exempt from manufacturing defects. The warranty does not cover aesthetic defects, meaning finishes difference or shades in the outward appearance of the products. The Vendor is also not responsible for defects in conformity and defects in the Products due to normal wear. The Vendor likewise is not liable for defects in conformity of the Products and defects caused by non-compliance, even partial, of the rules provided in the instruction manual/product data sheet, maintenance and/or cleaning with unsuitable products and/or materials and from incorrect choice by the Customer of the Product ordered for the purpose and intended use. This warranty does not extend to defects due to tampering or improper use of the Products, negligent preservation thereof, causes of force majeure. The Vendor assumes no responsibility for damages resulting from the installation of the Products supplied. The Vendor declines all responsibility for any damage that may, directly or indirectly, derive from persons or things as a result of failure to comply with all the requirements indicated in the documentation accompanying the Products, and in particular that concern the warnings regarding installation, use and maintenance.

## 12) REPORTING OF FAULTS AND DEFECTS

The Products purchased must be verified and checked by the Buyer upon receipt. Any apparent defects of the Goods supplied (packaging status, quantity, species, or external characteristics of the Products, etc.) must, under penalty of forfeiture, be contested at the time of delivery directly to the carrier on the transport document and notified not later than 7 (seven) days to the Vendor by registered letter with return receipt or other means of communication that assures the proof and date of receipt (e.g. Certified Electronic Email). After this deadline, the Products will be considered for all purposes accepted; furthermore, the use and/or installation and/or laying of the Products presenting apparent defects, excludes the possibility of disputes or complaints concerning the defects themselves. Any hidden defects (defects not identifiable through diligent control at the time of receipt of the Products) must be notified by the Buyer, under penalty of forfeiture, to the Vendor by registered letter with return receipt or other means of communication that assures the proof and date of receipt (e.g. Certified Electronic Email), within 8 (eight) days of discovery and in any case no later than 12 (twelve) months from delivery to the Buyer. It is understood that the successful use and/or installation and/or laying of the Products that have manifested defects, excludes the possibility of disputes or complaints concerning the defects themselves, implying acceptance of the Products for all purposes. Each complaint must accurately specify the defect found; the Products object of the dispute must always be made available to the Vendor's agents for their verification. Any complaints or disputes will not entitle the Buyer to suspend or delay payments due to the Vendor in any way.

Following a regular complaint by the Customer, within the terms indicated above, the Vendor will only perform the free replacement of the Product recognized as defective by the Vendor, Product that will be accepted in return from the same Vendor only in original packaging, undamaged and complete. Any disputes concerning a single delivery do not exonerate the Customer from the obligation to withdraw the remaining quantity of Products provided for by the specific Order, or by other Orders distinct from the one in question, nor do they entail the termination of the Contract.

## 13) LIMITATION OF LIABILITY

Any compensation for defective goods to be paid to the Buyer cannot in any case exceed the consideration paid and relative to the quantity of defective Goods. This warranty lasts 12 (twelve) months from the delivery of the Goods, it shall replace and supersede all legal guarantees and/or responsibilities provided by law and excludes any other responsibility of the Vendor, however, originating from the Goods supplied or their resale; in particular, the Buyer cannot make further claims for indemnity or compensation for damages, direct or indirect, of any nature, price reduction or termination of the Contract. Following the term of the warranty, no claim can be made against the Vendor.

## 14) RETENTION OF TITLE

This sale is carried out with retention of title (art. 1523 Italian Civil Code et seq.): therefore the Products remain the property of the Vendor until full payment of the price by the Buyer. Failure to pay, even partially, entitles the Vendor to reserve the right to undertake any other action, to directly recover the Goods under consideration in the supply, even if held by third parties. The Buyer acquires the property right of the Goods only following full payment of the related price to the Vendor in addition to ancillary charges, but assumes the risks from the time of delivery and will be liable for any damage or loss of the Goods (for example due to poor maintenance or negligence).

## 15) INDUSTRIAL AND INTELLECTUAL PROPERTY

Any distinguishing mark and/or production and commercial technology of the Vendor, whether registered and/or patented or not, must be treated as confidential by the Customer and must not be used or disclosed without the prior written authorization of the Vendor. All printed matter and other documents (price lists, catalogues or other similar documents, even on IT and digital support) relating to the Products are the exclusive property of the Vendor, covered by copyright. Their reproduction, even if only partial, is prohibited unless previously authorized by the Vendor. The Vendor warns against the unauthorized use of its own brand, and/or other trademarks shown on the Products or connected to the Products supplied, and/or distinguishing names or marks, as well as patents, models and drawings relating to their Products.

## 16) APPLICABLE LAW AND EXCLUSIVE JURISDICTION

Except when agreed in these General Terms and Conditions of Sales, the Italian law shall apply to these General Terms and Conditions of Sales and to each Sales Contract completed between Vendor and Buyer. The application of the United Nations Convention on contracts for the international sales of movable property, adopted in Vienna on 11.4.1980, is expressly excluded. For any dispute connected or arising from these General Terms and Conditions of Sales and/or Orders and/or Contracts, the Court of Treviso (Italy) shall have exclusive jurisdiction.

## 17) PRIVACY

In the execution of these General Terms and Conditions and/or of each Contract, personal and contact data (personal data, company e-mails, company telephones, smartphones) may be communicated to each other between Vendor and Buyer, or in any case made available to the respective contacts. For business use, etc.) of administrators, employees and collaborators who, depending on the duties and tasks assigned, manage the Contract and/or execute it. Therefore, both parties will process such personal data to the extent that they are strictly necessary for the execution of all aspects of the Contract (if any); and with their transfer, in consideration of the execution of the Contract, also in extra EU countries. Data shall be retained until the completion of the reciprocal services covered by the Contract and subsequently on the basis of the prescribed terms for the deeds and documents of the entrepreneur. The individual employee or collaborator can exercise all the rights listed in articles 15 to 21 of Regulation EU 2016/679, without prejudice, however, to the limits deriving from the legitimate interest of the employer.

Place and date **Asolo, 01/04/2019**

Signature of Progress Profiles SPA

Signature of the Buyer

Pursuant to and for the purposes of articles 1341 and 1342 of the Italian Civil Code, the Buyer declares to have read all the terms and conditions of this Contract and to expressly approve the following clauses: 4 (DELIVERY TERMS, TRANSPORT OF GOODS), 5 (FORCE MAJEURE), 6. (REFUSAL TO RECEIVE DELIVERY), 8 (PRICES, PAYMENTS AND DEFINITION OF DEFAULT INTERESTS) 9 (SUSPENSION OF PERFORMANCE AND TERMINATION) , 10 (CHANGES AND CONFORMITY) 11 (WARRANTY AND LIMITS), 12 (REPORTING OF FAULTS AND DEFECTS) 13 (LIMITATION OF LIABILITY), 16( APPLICABLE LAW AND EXCLUSIVE JURISDICTION).

Place and date **Asolo, 01/04/2019**

Signature of Progress Profiles SPA

Signature of the Buyer





# WATCH OUT FOR DAMAGE

OPERATIONS TO BE CARRIED OUT IN PRESENCE OF THE CARRIER

1

PROGRESS PROFILES SPA (DATI IN CALCE)			
NEL D.D.T. E COMUNICATI ENTRO 48 ORE.			
LINEA	PESO LORDO/BRUTO IN KG	PESO NETTO/NET IN KG	NUMERO COLLI
04	9,00	9,00	3,00
FIRMA DEL COMPILATORE			
FIRMA DEL VET			

1. Verify whether the number of packages corresponds to the number indicated in the transport documents

2

LINEA	DESCRIZIONE	UNITA'	Q.TA
04	PROFILATO IN ACCIAIO	M	25
05	PROFILATO IN ACCIAIO	M	54
06	PROFILATO IN ACCIAIO	M	21
07	PROFILATO IN ACCIAIO	M	21

MERCE ACCETTATA CON  
RISERVA PER  
INVOLUCRO DANNEGGIATO

2. Verify the state of the outer packaging and on the carrier bulletin write: *"accepted with reserve"* specifying the type of anomaly

3



3. Open the packaging and verify the goods

4

PROGRESS  
IN CASO DI RECLAMI INVIARE UN FAX AL N° +39 0423 950 979

**MODULO RISOLUZIONE N.C.  
MATERIALE - PARTE A**

Si prega di compilare il presente modulo in ogni sua parte

Profilo Cliente	Nome Cliente	Indirizzo	Telefono	Fax
0261731422	Harbo Bossi	Via G. G. G. S.	0423 35422	0423 950979
Coordinate Rappresentante	Area di appoggio	Agente	ABI	N° conto

Motivazione contribuzione  Riferimento

Materiale danneggiato  D

Materiale mancante

Materiale non conforme per:  qualità  quantità

Descrizione materiale  
Cod. / Articolo: P3/AA H: 40 cm

4. Fill in the *"n.c. resolution form"* (see next page)

5

5. Send the *"n.c. resolution form"* and a copy of the reserve made to the carrier to fax number +39 0423 950979 or by e-mail to: [cSERVICE@progressprofiles.com](mailto:cSERVICE@progressprofiles.com)

In the event of damage or any other anomaly, if no reserve has been specified on the transport document, you will not be entitled to any compensation.

The reserve is a right enshrined in the Civil Code (art. 1688).

IN THE CASE OF COMPLAINT, SEND A FAX TO No. +39 0423 950 979  
or E-MAIL: cservice@progressprofiles.com

## FORM FOR NON-CONFORMING MATERIAL - PART A

Please fully complete this form

### Business name:

Customer Name \_\_\_\_\_  
Street \_\_\_\_\_  
District \_\_\_\_\_ Zip Code \_\_\_\_\_  
Province \_\_\_\_\_  
e@mail \_\_\_\_\_  
VAT No. \_\_\_\_\_  
Tel. \_\_\_\_\_ Fax \_\_\_\_\_

### Reason for complaint:

- damaged material  
 missing material  
 correct documents (confirm/transport documents) but non-conforming material  
Material non-conforming in:  quality  
 quantity

### Dispatch references:

Preform Invoice \_\_\_\_\_ ORD. N° \_\_\_\_\_  
Date \_\_\_\_\_  
Name of carrier \_\_\_\_\_

### Description of material

Cod. / Article	Description	U.M.	Quantity

### Required action:

- Return of goods  
 Sending of material

Date and place \_\_\_\_\_

Signature of agent in confirmation

Signature of customer in acceptance

\_\_\_\_\_

\_\_\_\_\_

# GUIDE TO CONSULTATION

application example	description	finish	name																																				
<p><b>SOL 40P SELF-ADHESIVE</b> is a joint/threshold cover profile in aluminum covered with film in wooden finishes, which is highly resistant to pedestrian traffic, wear, UV rays and commonly used floor cleaning products. Easy to lay and to match with any wood finish; the surface has an open pore embossed finish. Recommended for covering joints between floors in laminate, wood, ceramic tiles, etc.</p> <p><b>SOL 40P SELF-ADHESIVE</b> ALUMINIUM COVERED WOODEN FINISHES</p> <p>type of profile</p> <p>technical drawings</p>	<p><b>SILVER ANODIZED ALUMINIUM with ADHESIVE thermo packed</b> - bar length 90 cm - pack: 20 Pcs</p> <table border="1"> <thead> <tr> <th>Article</th> <th>L mm</th> <th>€/Pc</th> </tr> </thead> <tbody> <tr> <td>PNSPAA 409 PAS</td> <td>40</td> <td>7,46</td> </tr> </tbody> </table> <p><b>ALUMINIUM COVERED 80 wooden finishes (49 on demand) with ADHESIVE - thermo packed</b> - bar length 0,90 lm - 20 Pcs</p> <table border="1"> <thead> <tr> <th>Article</th> <th>L mm</th> <th>€/Pc</th> </tr> </thead> <tbody> <tr> <td>PNSP... 409 PAS</td> <td>40</td> <td>14,07</td> </tr> </tbody> </table> <p><b>ALUMINIUM COVERED 80 wooden finishes (49 on demand) with ADHESIVE - thermo packed</b> - bar length 1 lm - 20 Pcs</p> <table border="1"> <thead> <tr> <th>Article</th> <th>L mm</th> <th>€/Pc</th> </tr> </thead> <tbody> <tr> <td>PNSPAA 404 PAS</td> <td>40</td> <td>8,24</td> </tr> </tbody> </table> <p><b>ALUMINIUM COVERED 80 wooden finishes (49 on demand) with ADHESIVE - thermo packed</b> - bar length 1 lm - 20 Pcs</p> <table border="1"> <thead> <tr> <th>Article</th> <th>L mm</th> <th>€/Pc</th> </tr> </thead> <tbody> <tr> <td>PNSP... 404 PA</td> <td>40</td> <td>13,79</td> </tr> <tr> <td>PNSP... 404 PA</td> <td>40</td> <td>37,22</td> </tr> </tbody> </table> <p><b>SILVER ANODIZED ALUMINIUM with ADHESIVE - thermo packed</b> - bar length 1 lm - 20 Pcs</p> <table border="1"> <thead> <tr> <th>Article</th> <th>L mm</th> <th>€/Pc</th> </tr> </thead> <tbody> <tr> <td>PNSP... 4010 PAS</td> <td>40</td> <td>15,42</td> </tr> </tbody> </table> <p>Available in the colours: 04W - 05W - 07W - 09W - 13W - 18W - 21W - 25W - 29W - 30W - 31W - 32W - 33W - 34W - 35W - 36W - 37W - 38W - 39W - 41W - 42W - 44W - 45W - 46W - 48W - 49W - 52W - 54W - 55W - 62W - 73W - 75W. The code of the selected colour must be added to the article code. E.g.: PNSP... 40 PA (chosen finish dark beech) PNSP04W 40 PA.</p>	Article	L mm	€/Pc	PNSPAA 409 PAS	40	7,46	Article	L mm	€/Pc	PNSP... 409 PAS	40	14,07	Article	L mm	€/Pc	PNSPAA 404 PAS	40	8,24	Article	L mm	€/Pc	PNSP... 404 PA	40	13,79	PNSP... 404 PA	40	37,22	Article	L mm	€/Pc	PNSP... 4010 PAS	40	15,42					
Article	L mm	€/Pc																																					
PNSPAA 409 PAS	40	7,46																																					
Article	L mm	€/Pc																																					
PNSP... 409 PAS	40	14,07																																					
Article	L mm	€/Pc																																					
PNSPAA 404 PAS	40	8,24																																					
Article	L mm	€/Pc																																					
PNSP... 404 PA	40	13,79																																					
PNSP... 404 PA	40	37,22																																					
Article	L mm	€/Pc																																					
PNSP... 4010 PAS	40	15,42																																					
<p><b>PROCOVER WOOD</b> is a joint-cover profile in aluminum covered with a very strong film available in wooden finishes. It is applied at the end of laying two adjoining floors with the same height, having left a 6 - 24 mm gap between the two floors set in a thin bed of adhesive. It protects the outside edges of the floor/covering. It is easy to lay and attractive. The design of the profile with lower vertical arrowhead part allows excellent anchorage with the silicone/adhesive.</p> <p><b>PROCOVER WOOD</b> ALUMINIUM COVERED WITH PROTECTIVE FILM IN WOODEN FINISHES</p> <p>examples and instructions for laying methods</p>	<p><b>ALUMINIUM COVERED 80 wooden finishes (76 on demand) thermo packed</b> - bar length 2,7 lm - pack: 40 Pcs - 108 lm</p> <table border="1"> <thead> <tr> <th>Article</th> <th>L x H mm</th> <th>€/lm</th> <th>€/Pc</th> </tr> </thead> <tbody> <tr> <td>PCRA... 149</td> <td>14 x 9</td> <td>5,47</td> <td>14,77</td> </tr> <tr> <td>PCRA... 269</td> <td>26 x 9</td> <td>9,62</td> <td>25,97</td> </tr> </tbody> </table> <p>Available in the wooden finishes: 05W - 11W - 28W - 29W - 30W. The code of the selected colour must be added to the article code. Es.: PCRA... 149 (chosen finish light oak) PCRA04W 149.</p> <p><b>COLOURS</b></p> <table border="1"> <thead> <tr> <th>05W - light oak (oak)</th> <th>11W - Decage bleached</th> <th>28W - Aspen oak</th> <th>29W - White oak</th> <th>30W - Grey oak</th> </tr> </thead> <tbody> <tr> <td></td> <td></td> <td></td> <td></td> <td></td> </tr> </tbody> </table> <p>On request it is possible to realize other finishes of the color range: minimum order 200 pcs. Production delay 4/5 weeks. Price to be agreed. For sample finishes, contact the sales office for minimum quantities, timing and costs.</p>	Article	L x H mm	€/lm	€/Pc	PCRA... 149	14 x 9	5,47	14,77	PCRA... 269	26 x 9	9,62	25,97	05W - light oak (oak)	11W - Decage bleached	28W - Aspen oak	29W - White oak	30W - Grey oak																					
Article	L x H mm	€/lm	€/Pc																																				
PCRA... 149	14 x 9	5,47	14,77																																				
PCRA... 269	26 x 9	9,62	25,97																																				
05W - light oak (oak)	11W - Decage bleached	28W - Aspen oak	29W - White oak	30W - Grey oak																																			
<p><b>PROCOVER INSERT</b> VINYL RESIN / BLACK RUBBER</p> <p>Vinyl resin/rubber profile "U-form" for inserting PROCOVER with PINBFT 45 or PINBFT 40 Proinsert System base.</p> <p><b>VINYL RESIN / RUBBER</b> length 2,7 lm and/or in rolls</p> <table border="1"> <thead> <tr> <th>Article</th> <th>€/lm</th> <th>€/Roll</th> </tr> </thead> <tbody> <tr> <td>PPCR</td> <td>3,32</td> <td>8,96</td> </tr> </tbody> </table> <p><b>PROINSERT BASE 45 and BASE 40 - ALUM. PUNCHED/PERFORED</b> bar length 2,7 lm - pack: 20 Pcs - 54 lm</p> <table border="1"> <thead> <tr> <th>Article</th> <th>H mm</th> <th>€/lm</th> <th>€/Pc</th> </tr> </thead> <tbody> <tr> <td>PINBFT 45</td> <td>45</td> <td>5,28</td> <td>14,26</td> </tr> <tr> <td>PINBFT 40</td> <td>40</td> <td>5,21</td> <td>14,06</td> </tr> </tbody> </table> <p>Prices are referred to whole packs: 10% increase for minimum orders of 10 Pcs 20% increase for orders of less than 10 Pcs.</p>	Article	€/lm	€/Roll	PPCR	3,32	8,96	Article	H mm	€/lm	€/Pc	PINBFT 45	45	5,28	14,26	PINBFT 40	40	5,21	14,06	<p><b>PROCOVER INSERT</b> VINYL RESIN / BLACK RUBBER</p> <p>Vinyl resin/rubber profile "U-form" for inserting PROCOVER with PINBFT 45 or PINBFT 40 Proinsert System base.</p> <p><b>VINYL RESIN / RUBBER</b> length 2,7 lm and/or in rolls</p> <table border="1"> <thead> <tr> <th>Article</th> <th>€/lm</th> <th>€/Roll</th> </tr> </thead> <tbody> <tr> <td>PPCR</td> <td>3,32</td> <td>8,96</td> </tr> </tbody> </table> <p><b>PROINSERT BASE 45 and BASE 40 - ALUM. PUNCHED/PERFORED</b> bar length 2,7 lm - pack: 20 Pcs - 54 lm</p> <table border="1"> <thead> <tr> <th>Article</th> <th>H mm</th> <th>€/lm</th> <th>€/Pc</th> </tr> </thead> <tbody> <tr> <td>PINBFT 45</td> <td>45</td> <td>5,28</td> <td>14,26</td> </tr> <tr> <td>PINBFT 40</td> <td>40</td> <td>5,21</td> <td>14,06</td> </tr> </tbody> </table> <p>Prices are referred to whole packs: 10% increase for minimum orders of 10 Pcs 20% increase for orders of less than 10 Pcs.</p>	Article	€/lm	€/Roll	PPCR	3,32	8,96	Article	H mm	€/lm	€/Pc	PINBFT 45	45	5,28	14,26	PINBFT 40	40	5,21	14,06		
Article	€/lm	€/Roll																																					
PPCR	3,32	8,96																																					
Article	H mm	€/lm	€/Pc																																				
PINBFT 45	45	5,28	14,26																																				
PINBFT 40	40	5,21	14,06																																				
Article	€/lm	€/Roll																																					
PPCR	3,32	8,96																																					
Article	H mm	€/lm	€/Pc																																				
PINBFT 45	45	5,28	14,26																																				
PINBFT 40	40	5,21	14,06																																				

## CODE COMPOSITION

EXAMPLE REGARDING METAL PROFILE:

**PLSOL 308FS**

base code | chosen finish | height or width | self pack | perforated

EXAMPLE REGARDING PLASTIC PROFILE:

**PEG 25-01A**

base code | height or width | adhesive | chosen colour

EXAMPLE REGARDING PAINTED ALUMINIUM:









**PEGA 25-01A**

base code | height or width | adhesive | aluminium | chosen colour

# SELF PACK and ECO BLISTER

The **SELF PACK** range consists of blister profiles with adhesive labels with all the explanations for the interpretation of technical information regarding our profiles (code, length, finish, etc.). In the perforated version, screws and plugs are included. The **ECO BLISTER** range consists of blister profiles without explanation label but provided only with an EAN barcode. In the perforated version, screws and plugs are not included. Both have 4 colours to identify the 4 types of profiles (blue for window sill covers, red for fitting terminals, yellow for step covers, and beige for the proinsert system).



THRESHOLD-COVER PROFILES	TRANSITION PROFILES	STEP NOSING	PROINSERT SYSTEM
 ↓ Prosol Proplate Prolevall	 ↓ Prolevall 29/33/305 Proskid Propress 712 Profloor Promoquette Promoquette Fix	 ↓ Proend Grip Proend Ins Proend Prowalk Tube for runners Progrid	 ↓ Sol 30 self-adhesive Zero Curve self-adhesive Profixer Line System Sol 40P Terminal Pin Zero Curve Terminal
 SERIE PROSOL L. 14 - 30 - 35 - 40 mm ARTICOLO PLSOTA 3010 103 cm OTTONE LUCIDO POLISHED BRASS LAITON BRASS MESSING GLANZEND AUTOADESIVO SELF-ADHESIVE AUTOADHESIF SELBSTKLEBEND MADE IN ITALY	 SERIE PROLEVALL 29 - 33 - 305 305 - 305 - 4412 ARTICOLO PLVA 339 90 cm OTTONE BRASS LAITON MESSING AUTOADESIVO SELF-ADHESIVE AUTOADHESIF SELBSTKLEBEND MADE IN ITALY	 SERIE PROWALK L. 22 - 30 mm ARTICOLO PWKA 309 90 cm OTTONE BRASS LAITON MESSING AUTOADESIVO SELF-ADHESIVE AUTOADHESIF SELBSTKLEBEND MADE IN ITALY	 SERIE SOL 40P COMPLETO 40 mm ARTICOLO PISPINC 4079S 90 cm NOCE ROSATO RED WALNUT NOYER ROSE NUSS ROSE AUTOADESIVO SELF-ADHESIVE AUTOADHESIF SELBSTKLEBEND MADE IN ITALY
			Photos Article Size Code Fixing system Profile length Material Finishes EAN Code

## LAYING INSTRUCTION

### LAYING INSTRUCTIONS: SELF-ADHESIVE

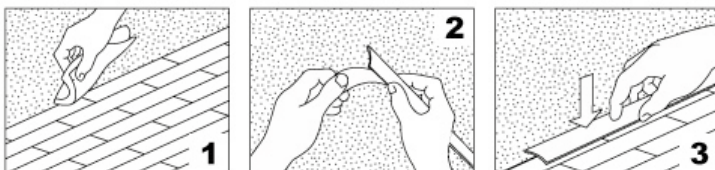

- 1) Clean the adhesion area. The surface must be dry, dust free, grease free, and non-friable.
- 2) Remove the protective paper.
- 3) Lay the profile and press evenly on the entire length.

### LAYING INSTRUCTIONS: WITH SCREWS/PLUGS



- 1) Drill holes in the floor taking care that they match the holes on the profile.
- 2) Insert the plugs in the holes.
- 3) Tighten the profile.

**Progress Profiles SpA**  
Via Le Marze 7  
31011 ASOLO (TV) Italy

Tel. +39 0423 950398  
Fax +39 0423 950979  
Certified company UNI EN ISO 9001:2015

P.I. IT 03481880262 - R.E.A. TV 275319  
C.F. e Iscr. Reg.Impr. TV 03481880262  
Cap. soc. € 120.000,00 i.v.  
N. Meccanografico TV 44685

## IMPORTANT:

Every time a price list will be given to your Client, we ask you to fill in this form and deliver it to the company Progress® Profiles s.p.a. fax: +39 0423 950 979 or mail: cservice@progressprofiles.com

Kind regards

President & CEO  
**Dennis Bordin**

Place \_\_\_\_\_

Date \_\_\_\_\_

Name Agent \_\_\_\_\_

To the attention of Mr. \_\_\_\_\_

Name Client \_\_\_\_\_

\_\_\_\_\_

\_\_\_\_\_

Reference person \_\_\_\_\_

(Stamp)

With the present we give the following material \_\_\_\_\_

\_\_\_\_\_

Catalogue / List \_\_\_\_\_ N° \_\_\_\_\_ Pcs \_\_\_\_\_

Discounts \_\_\_\_\_

Note \_\_\_\_\_

\_\_\_\_\_

\_\_\_\_\_

\_\_\_\_\_

\_\_\_\_\_

PROGRESS® PROFILES OFFICIAL CATALOGUE Rev.01\_22 - distribution of this catalogue is un controlled - Approval and issue: *Dennis Bordin* (D. Bordin) - Check: *M. Torresan* (M. Torresan)

Kind regards

© 2022 All rights reserved by Progress Profiles, Printed in Italy

# FINISHED PRODUCT AND RAW MATERIALS FEATURES

## STAINLESS STEEL:

The steel profiles are realised through cold shaping of constant thickness sheets, therefore, differentiating from the corresponding version in aluminium and brass realised by hot extrusion, despite maintaining the applicative and dimensional features. The stainless steel is efficiently resistant to mechanical stresses, particularly suitable in the chemical, food, hospital sector for responding to hygienic, duration and resistance to chemical agents requisites.

Normally produced with Polished finish, it is possible to realise a brushed finish that is implemented with the partial removal of material using nylon fibre and quartz rotary brushes that confer a brushed/satin matt look to the surface, without altering its features. The ultra-glossy finish happens by means of special brushes to create mirror polished finishes.

Produced in different chemical compositions, below are the main features:

AISI	DIN	*C	Cr	Ni	*Si	*Mn	Mo
430	1,4016	0,10	16,0+18,0	-	1,0	1,0	-
304	1,4301	0,06	18,0+20,0	8,0+10,5	1,0	2,0	-
316L	1,4404	0,03	16,0+18,0	11,0+13,0	1,0	2,0	2,0+2,5

\* Maximum admitted values

### STAINLESS STEEL AISI 430 – EN X 8 CR 17 – DIN 1.4016:

Chromium stainless steel forming part of the FERRITE category, despite being considered stainless it can easily be stained in presence of particularly aggressive products, and be contaminated by oxidising generated by other materials.

### STAINLESS STEEL AISI 304 – EN X 5 CRNI 18 10 – DIN 1.4301:

Nickel/chromium stainless steel forming part of the AUSTENITIC category is the most diffused and used alloy in the manufacturing of products with highly technical and performing features. Highly resistant to most chemical products it can superficially stain or darken; a normal polishing (e.g. sidol/ smac) product is sufficient to give it back its original state.

In presence of oxidising stains in the Brushed/satin version due to the brushes, simply use a wirewool.



### STAINLESS STEEL AISI 316 – EN X 2 CRNIMO 17 12 – DIN 1.4404:

Stainless steel AISI 316 is part of the AUSTENITIC category that is characterised by the internal presence of Molybdenum besides Nickel-Chromium. This feature confers an excellent resistance of the material in limit conditions, which the presence of Chlorine and Salt.

## APPLICATION FIELDS:

Material	Indoor	Outdoor	Floor	Wall	Heavy traffic	High chemical attack (*)	Food Contact	Pools	Thermal environments	Marine environments
STAINLESS STEEL AISI 316	yes	yes	yes	yes	yes	yes	yes	yes	yes	yes
STAINLESS STEEL AISI 304	yes	yes	yes	yes	yes	no	yes	no	no	no
STAINLESS STEEL INOX 1.4016	yes	no	yes	yes	no	no	no	no	no	no
NATURAL BRASS	yes	yes	yes	yes	yes	no	no	no	no	no
CHROME BRASS	yes	no	yes	yes	no	no	no	no	no	no
POLISHED VARNISHED BRASS	yes	no	no	yes	no	no	no	no	no	no
NATURAL ALLUMINIUM	yes	yes	yes	yes	yes	no	no	no	no	no
VARNISHED ALLUMINIUM	yes	yes	no	yes	no	no	no	no	no	no
WOOD EFFECT FINISHES ALLUMINIUM	yes	no	yes	yes	no	no	no	no	no	no
ANODIZED / POLISHED / BRUSHED ALLUMINIUM	yes	no	yes	yes	no	no	no	no	no	no
VINYL RESIN (PVC)	yes	no	no	yes	no	yes	no	yes	yes	yes

(\*) In the case of applications in environments where they are used special chemicals aggressivesve, consult the technical department.

## BRASS:

The brass profiles are characterised by a high resistance to mechanical stresses making it particularly suitable in heavy traffic applications like, for example, industrial applications with frequent pedestrian crossings. The brass is resistant to the main chemical agents intervening in ceramic coating applications. The surface of the profile, in presence of humidity or particularly aggressive agents, can show superficial oxidising phenomenon that can be removed by using a normal polishing product (e.g. Sidol and Smac).

The profiles can be realised by means of hot extrusion and cold shaping of constant thickness sheets.

### EXTRUSION ALLOY Cu Zn 43 Pb2 Al EN 12167 CW 624N

**Cu%	*Pb%	*Sn%	*Fe%	*Ni%	**Al%	Other%	Zn%
55-57	1,6-3	0,30	0,30	0,30	0,05-0,5	0,2	Remainder

\*\* Indicative values \* Maximum admitted values

### LAMINATING ALLOY Cu Zn 37 EN 1652 CW 508L

**Cu%	*Pb%	*Fe%	Zn%	Impurity%
67	0,1	0,1	Remainder	0,30

\*\* Indicative values \* Maximum admitted values

## POLISHED BRASS:

The polished finish is realised with special machines with springs/brushes that mechanically polish the surface without altering the intrinsic features of the material. A partial darkening of the surface in presence of oxidising materials is a phenomenon that can be contrasted using normal polishing products (e.g. Sidol and Smac).

## CHROMIUM BRASS:

The finish is obtained by beams of galvanic process that confers a brilliant look similar to the ultra-glossy stainless steel. The treatment confers an excellent aesthetical look, excellent resistance to chemical aggressions but limited resistance to mechanical superficial impacts and persistent abrasion.



# FINISHED PRODUCT AND RAW MATERIALS FEATURES

## ALUMINIUM:

Primary alloy suitable for complex extrusions, it is highly resistant and has excellent superficial finish at natural state making it ideal for successive finishing processes: Anodizing, Polishing, Painting. Hot hardened and tempered it reaches a Brinnel Hp hardness degree around 70 kg/mm<sup>2</sup>.

Aluminium ALLOY Mg 0,7 Si 0,4 Conventional Designation: P-Al Mg Si UNI 3569-66 UNI 6060

*Cu%	*Mn%	*Zn%	*Ti%	*Cr%	Si%	Mg%	*Fe%	Al%
0,10	0,10	0,15	0,10	0,10	0,3-0,6	0,35-0,6	0,1-0,3	Remainder

\* Maximum admitted values

## TILTEX & ANODIZED ALUMINIUM:

Anodic oxidation process against corrosion from atmospheric agents not combined with galvanic processes. The profiles are treated with preventive processes making them evenly matt. They are subsequently coloured by means of electro-chemical oxidation in the standard Silver, Gold, Bronze, Sand, Champagne colours with a thickness of about 15-20 micron.

The Anodized Copper and Titanium finishes are firstly superficially polished and, subsequently, subjected to the above process.

All TILTEX finishes are firstly subjected to a special superficial brushing and, subsequently, to the above process.

## BRUSHED & POLISHED ALUMINIUM:

It is made of a special preventive mechanical-chemical polishing treatment and subsequent anodic bath in Chrome and Gold colours. The obtained profiles maintain the same resistance to corrosion features of the anodized profiles, but with a brilliant aesthetical aspect, making them similar to the polished surfaces.

The Polished Copper and Titanium finishes are firstly subjected to superficial polish and, subsequently, to the above process.

All BRUSHED finishes are subjected to a special superficial brushing and, subsequently, to the above process.



## PAINTED ALUMINIUM:

The painting process is made of a chromium phosphate-based pre-treatment, of an electrostatic polyester-powder based paint with highly resistant features to U.V. rays and to atmospheric agents. The coating thickness covers the entire profile surface having an average thickness of approx. 50-70 micron. A hot mesh polymerisation process is also carried out for maximum guarantee of the chemical-mechanical resistance.

## VARNISHED ALUMINIUM WITH SEASIDE TREATMENT:

special pre-treatment to the epoxy-polyester coating, which increases the resistance to corrosion of the profile when installed at sea front. This treatment is certified after completing 2500 hours (104 days) exposure to saline acetic mist

## THERMOPLASTIC VINYL RESIN:



## RVA: RIGID THERMOPLASTIC SHOCKPROOF NON TOXIC VINYL RESIN:

Purposely studied material for optimising the performing features of rigid profiles for permanent indoor application with aesthetical and long-lasting requirements. Realised starting from primary pigments and resin, their PVC composition makes it suitable for a high range of applications up to a temperature of +50/60°C. The raw material used guarantees excellent resistance to U.V. rays, to limited chemical impacts and stagnation of fungus and bacteria.

FEATURES	TEST	UNIT OF MEASURE	INDICATIVE VALUE
Specific weight	ASTM D 792	gr/cm <sup>3</sup>	1,43 +/-0,02
Rockwell Hardness	ASTM D 785		108
VICAT Point	ISO 306	°C	83,7
Tensile strength at break	ASTM D 638	Mpa	50
Elongation at Break	ASTM D 638	%	100
IZOD Resistance with Cut	ASTM D 256	J/m	60
Yielding strength point	ASTM D 638	Mpa	48
Flammability	UL 94	CLASS	VO
Reaction to UV Rays	-	-	EXCELLENT RESISTANCE

## RVF: FLEXIBLE NON-TOXIC VINYL RESIN (PLASTICISED THERMOPLASTIC):

Same chemical features of RVC with which it is perfectly compatible in the CO-EXTRUSION process used by ourselves in most of the dilatation, fitting joints. Thanks to the nature of the used plasticisers, the material maintains its own essential flexible features in time.

FEATURES	TEST	UNIT OF MEASURE	INDICATIVE VALUE
Specific weight	CEI 20-34	gr/cm <sup>3</sup>	1,24 +/-0,2
Hardness	ISO 868	Sh-A	70 +/-2
Breaking load	ISO 527	N/mm <sup>2</sup>	> 13
Elongation at Break	ISO 527	%	300
Thermal stability at 200°C	ISO 182	min.	25
Apparent Rigidity Module	ISO R 458	Mpa	310
Cold Flex temperature	ISO R 458	°C	-30

## RVC: CO-EXTRUDED THERMOPLASTIC VINYL RESIN FOR CO-EXTRUSION:

Primary resin with chemical composition similar to RVA is characterised by a high resistance and optimised compatibility with regard to long-lasting adherence with plasticised resins used in the co-extrusion process, meaning the permanent joining of two materials with different degrees of Shore hardness.

FEATURES	TEST	UNIT OF MEASURE	INDICATIVE VALUE
Specific weight	ISO 1183	gr/cm <sup>3</sup>	1,40 +/-0,5
Hardness	ISO 868	Sh-A	75 +/-2
Breaking load	ISO 527	Mpa	> 18
Elongation at Break	ISO 527	%	> 350
Stiffening temperature	ISO 1183	°C	-40 +/- 2

## EPDM AND NEOPRENE VULCANISED RUBBER:

The vulcanised rubber is a modified mix of EPDM and NEOPRENE of Grey or Black colour: below are the particular features:

Excellent mechanical properties in a working temperature interval from -35°C t + 100°C; Resistance to aqueous, oily and hydrocarbon fluids. Low permanent deformation with compression and pulling. Excellent resistance to ageing. Excellent resistance to dynamic fatigue and laceration. The intrinsic features of the material make it particularly suitable in the realisation of profiles where high stresses in time are requested, both indoor and outdoor.

FEATURES	TEST	UNIT OF MEASURE	INDICATIVE VALUE
Specific weight	DIN 53420	gr/cm <sup>3</sup>	1,21
Hardness	DIN 53505	Shore A	60 +/-3

## RESISTANCE TO CORROSIVE AGENTS:

Below is the indicative resistance towards the main diluted chemical agents and elements. Normally, the PVC products must never come into contact with Aromatic hydrocarbons, Ketones and Esters.

For further information on the materials write to our technical department.

CORROSIVE AGENT	RIGID VINYL RESIN CONCENTRATION (RVA)
Weak acids reaction	Null
Weak acids reaction	Null
Reaction to alcohol, aliphatic hydrocarbons, oils	Null
Reaction to Ketones, esters, aromatic hydrocarbons	DISSOLUTION
Flammability	CLASS VO UL94
Reaction to UV Rays	excellent resistance



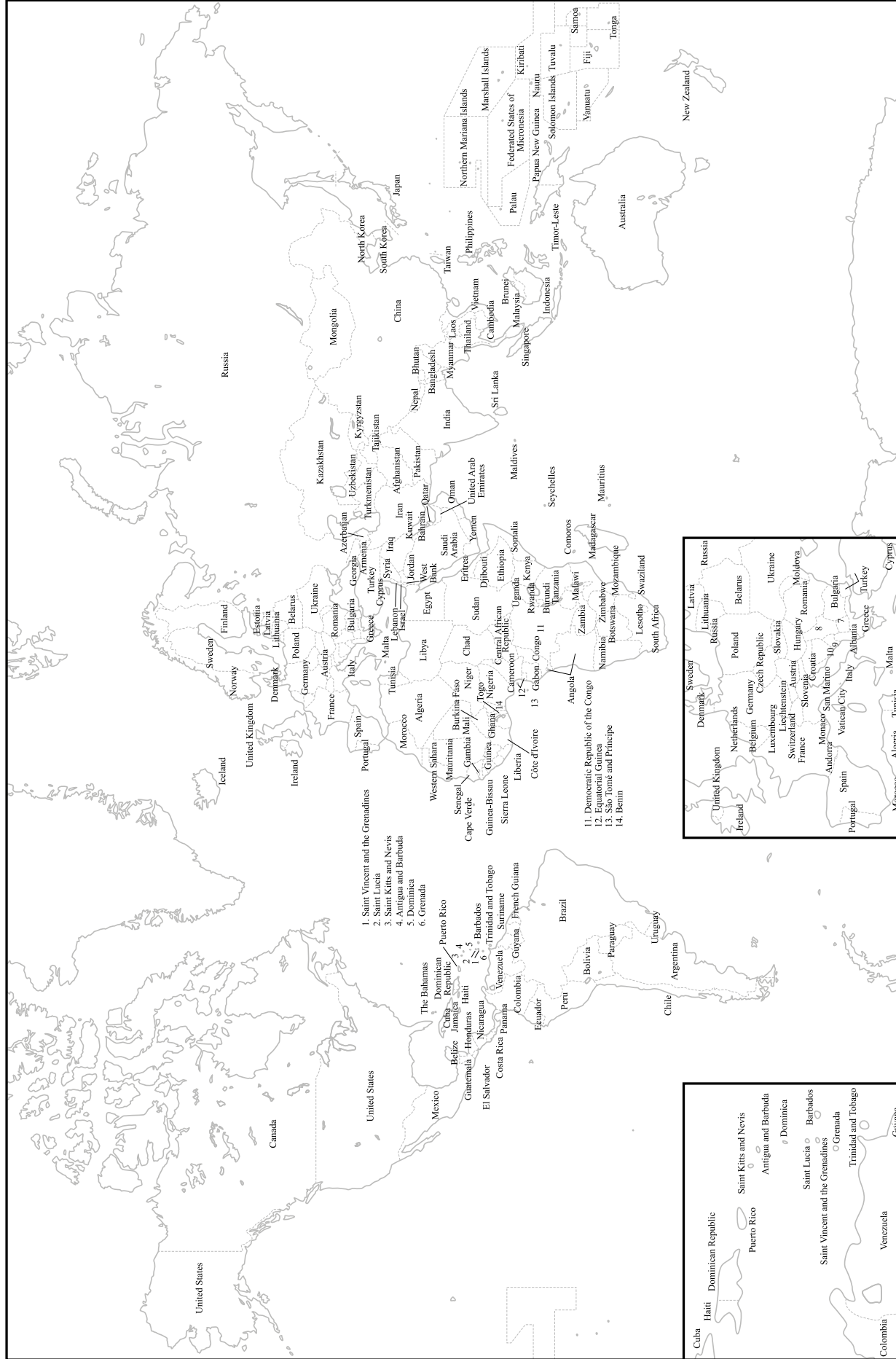



STEEL

Polished stainless steel AISI 304/1.4301-V2A	<b>AC</b>
Super polished stainless steel AISI 304/1.4301-V2A	<b>ACML</b>
Satin finish stainless steel AISI 304/1.4301-V2A	<b>ACS</b>
Sanded stainless steel AISI 304/1.4301-V2A	<b>ACSB</b>
Polished stainless steel AISI 316L/1.4404-V4A	<b>ACM</b>

BRASS

<b>ON</b>	Natural brass
<b>OL</b>	Polished brass
<b>OC</b>	Chromed brass
<b>OB</b>	Antique brass
<b>OS</b>	Brushed brass

ALUMINIUM

Natural aluminium	<b>AN</b>
Anodised silver aluminium	<b>AA</b>
Polished chrome aluminium	<b>BC</b>
Brushed silver aluminium	<b>BS</b>
Brushed silver titelex aluminium	<b>BX</b>
Anodised copper aluminium	<b>AR</b>
Polished copper aluminium	<b>BR</b>
Brushed copper aluminium	<b>RS</b>
Brushed copper titelex aluminium	<b>RX</b>
Brushed black aluminium	<b>NS</b>
Anodised black aluminium	<b>NE</b>
Polished black aluminium	<b>BN</b>

<b>AT</b>	Anodised titanium aluminium
<b>BT</b>	Polished titanium aluminium
<b>TS</b>	Brushed titanium aluminium
<b>TX</b>	Brushed titanium titelex aluminium
<b>AO</b>	Anodised Gold aluminium
<b>BO</b>	Polished Gold aluminium
<b>BOS</b>	Brushed Gold aluminium
<b>AB</b>	Anodised Bronze aluminium
<b>DB</b>	Anodised dark Bronze aluminium
<b>BRA</b>	Anodised antique bronze aluminium
<b>BRAS</b>	Brushed antique bronze aluminium
<b>CH</b>	Anodised champagne aluminium
<b>SB</b>	Anodised sand aluminium

VARNISHED ALUMINIUM

White (9016)	<b>01</b>
Matt White (9016)	<b>010</b>
White ivory (9001)	<b>0106</b>
Light grey (7035)	<b>02</b>
Stone grey (7030)	<b>03</b>
Quartz grey (7039)	<b>0211</b>
Asphalt grey (7043)	<b>0311</b>
Ivory (1015)	<b>06</b>
Klinker red (8004)	<b>10</b>
Black (9005)	<b>11</b>
Bahama beige	<b>17</b>
Tuscany grey	<b>03TU</b>
Tuscany beige	<b>05TU</b>
Tuscany bronze	<b>20TU</b>

VARNISHED ALUMINIUM STONE LINE

Stone white	<b>SL01</b>
Stone cream	<b>SL02</b>
Stone greyvory	<b>SL03</b>
Stone sand	<b>SL04</b>
Stone gray	<b>SL05</b>
Stone cristal gray	<b>SL06</b>
Stone antragray	<b>SL07</b>

VARNISHED ALU. (only Proterrace)

<b>B</b>	White (9010)
<b>G</b>	Grey (7038)
<b>T</b>	Dark brown (8019)
<b>E</b>	Beige (1019)

VARNISHED ALU. (embossed)

<b>BF</b>	White (9010)
<b>GF</b>	Grey (7038)
<b>A</b>	Anthracite grey
<b>TF</b>	Dark brown (8019)
<b>C</b>	Corten
<b>EF</b>	Beige (1019)

<b>SL08</b>	Stone antradark
<b>SL09</b>	Stone bronze
<b>SL10</b>	Stone corten
<b>SL11</b>	Stone brown
<b>SL12</b>	Stone black
<b>SL13</b>	Stone oyster grey

MARBLED on demand

Carrara white	<b>MC</b>	<b>MNA</b>	Navona**
Real yellow beige	<b>MB</b>	<b>MBC</b>	Polished chrome**
Sky blue	<b>MA</b>	<b>MBD</b>	Bardiglio**
Portugal pink	<b>MR</b>	<b>MGV</b>	Veined grey**
Guatemalan green	<b>MV</b>	<b>MGVC</b>	Light veined grey**
Aquamarine green	<b>MVA</b>	<b>MBPS</b>	Salt-and-pepper beige**
Soft blue	<b>MAS</b>	<b>MCRI</b>	Ivory cream**
Soft pink	<b>MRS</b>	<b>MCRC</b>	Light cream**
Soft beige	<b>MBS</b>	<b>MBO</b>	Polished gold**
Soft green	<b>MVAS</b>	<b>MAM</b>	Macauba blue**
Travertino light	<b>MTC</b>	<b>MAB</b>	Blue**
Travertino dark	<b>MTS</b>	<b>MBDX</b>	Burgundy**
		<b>MVBL</b>	Brazil green**

\*\*Production on demand with a minimum order of 800 pcs. Production delay 4/5 weeks. Price to be agreed

**WOOD**

similar finishes are indicated between brackets

Dark beech <b>04W</b>	Light oak (strip) <b>05W</b>	Dark oak (walnut) <b>06W</b>	Light cherry (strip) <b>07W</b>
Dark cherry (board) <b>08W</b>	Red walnut (Merbau-apple-walnut) <b>09W</b>	Wengé (panga panga-wengé) <b>10W</b>	Bleached decapè <b>11W</b>
Indonesian teak <b>13W</b>	Light zebrano <b>18W</b>	Powder oak <b>21W</b>	Bleached fir <b>25W</b>
Aspen oak <b>28W</b>	White oak <b>29W</b>	Grey oak <b>30W</b>	Victoria oak <b>31W</b>
Pink oak <b>32W</b>	Sawed oak <b>33W</b>	Havana oak <b>34W</b>	Edimburgo oak <b>35W</b>
American oak <b>36W</b>	Carvi oak <b>37W</b>	Queens oak <b>38W</b>	Grey elm <b>39W</b>
Brown oak <b>40W</b>	Ice oak <b>41W</b>	Grace oak <b>42W</b>	Manhattan oak <b>43W</b>
Honey oak <b>44W</b>	Morocco oak <b>45W</b>	Black decapè <b>46W</b>	Black oak <b>47W</b>
<b>48W</b>	<b>49W</b>	<b>50W</b>	<b>51W</b>
Cork oak <b>52W</b>	Sand oak <b>53W</b>	<b>54W</b>	<b>55W</b>
<b>56W</b>	<b>57W</b>	<b>58W</b>	<b>59W</b>
<b>60W</b>	<b>61W</b>	<b>62W</b>	<b>63W</b>
<b>64W</b>	<b>65W</b>	<b>66W</b>	<b>67W</b>
<b>68W</b>	Tripoli <b>69W</b>	<b>70W</b>	<b>71W</b>
<b>72W</b>	<b>73W</b>	<b>74W</b>	<b>75W</b>
<b>76W</b>	Bangkok <b>77W</b>	<b>78W</b>	<b>79W</b> Liotard
<b>80W</b>	<b>81W</b>	<b>82W</b>	<b>83W</b>
<b>84W</b>	<b>85W</b>	<b>86W</b>	<b>87W</b>
<b>88W</b>	<b>89W</b>	<b>90W</b>	<b>93W</b> New white
<b>94W</b>	<b>95W</b>	<b>97W</b>	
Mahogany* <b>M</b>	Natural Oak**		

(for a precise assessment of colours and finishes, request the wood finishes sample range)  
 \*available only with Angle bar AGEM 25 and Skirting BTPRM 70  
 \*\*available only with Proslider wood, Prostair wood and wood z, Prostep wood, Prostyle wood

**Rigid PVC**

White ice <b>00</b>	<b>15</b> Brown
White <b>01</b>	<b>16</b> Blue
White ivory <b>0106</b>	<b>17</b> Bahama beige
Light grey <b>02</b>	<b>18</b> Grey
Cement grey <b>03</b>	<b>19</b> Beige**
Light beige <b>04</b>	<b>20</b> Dark ivory**
Dark beige <b>05</b>	<b>21</b> Light pink**
Ivory <b>06</b>	<b>22</b> Dark pink**
Pink <b>07</b>	<b>23</b> Dark antique pink**
Sky blue <b>08</b>	<b>24</b> Dark sky blue**
Yellow <b>09</b>	<b>25</b> Brick red**
Red <b>10</b>	<b>26</b> Turquoise green**
Black <b>11</b>	<b>27</b> Dark green**
Silver <b>12</b>	<b>28</b> Hazel brown**
Gold <b>13</b>	<b>29</b> Dark brown**
Green <b>14</b>	

\*\*Production on demand with a minimum order of 800 pcs. Production delay 4/5 weeks. Price to be agreed



**Flexible / Expanded PVC**

White <b>B</b>
Light grey <b>GC</b>
Dark grey <b>GS</b>
Brown Only for Flexible PVC <b>M</b>
Dark Brown Only for Flexible PVC <b>T</b>
Black <b>N</b>

**INSERTS steps - vinyl rubber**

<b>A</b>	Ivory
<b>G</b>	Grey
<b>B</b>	Beige
<b>N</b>	Black

**INSERTS joints - vinyl rubber**

<b>G</b>	Grey
<b>N</b>	Black

**JOINTS rigid part - rigid PVC / flexible part - plastified PVC**

Dark grey Dark grey <b>GS</b>	51	E 86
Dark grey Transparent <b>GT</b>	51	E 80

<b>GL</b>	50	E 82	Light grey Light grey
-----------	----	------	--------------------------

**JOINTS rigid part - rigid PVC / flexible part - plastified PVC**

Brick red * Transparent <b>RT</b>	52	E 80
White * White <b>BIBI</b>		
Beige * Beige <b>BB</b>	54	54

<b>MT</b>	53	E 80	* Brown Transparent
<b>N</b>			* Black Black

\* Production on demand with a minimum order of 400 pcs. Production delay 4/5 weeks. Price to be agreed

**PRODILAT & JOINTS flexible part - EPDM**

Grey <b>G</b>
------------------

<b>N</b>	Black
----------	-------

WOOD

PVC

